

GENERAL CATALOGUE

BDC ELECTRONIC S.r.l. was born in 1970.

Being the first in Italy to produce proximity sensors, it has gained in its business a lot of experience, thanks to its abilities to suit the market requirements.

The extremely agile company organization is able to satisfy customer's needs, assuring a high quality and reliable production, appreciated all over the world.

Research and development is constantly working in order to offer solution to any kind of problem and to find new applications.

All the products are engineered to work even in the hardest and most difficult conditions.

The use of a quality system, certified according to standard ISO 9001:2000, grants the best care and precision in the fulfillment of all the realization stages: from the engineering to the production, through a manufacturing process with high level of automation and rigorous testings on each product.

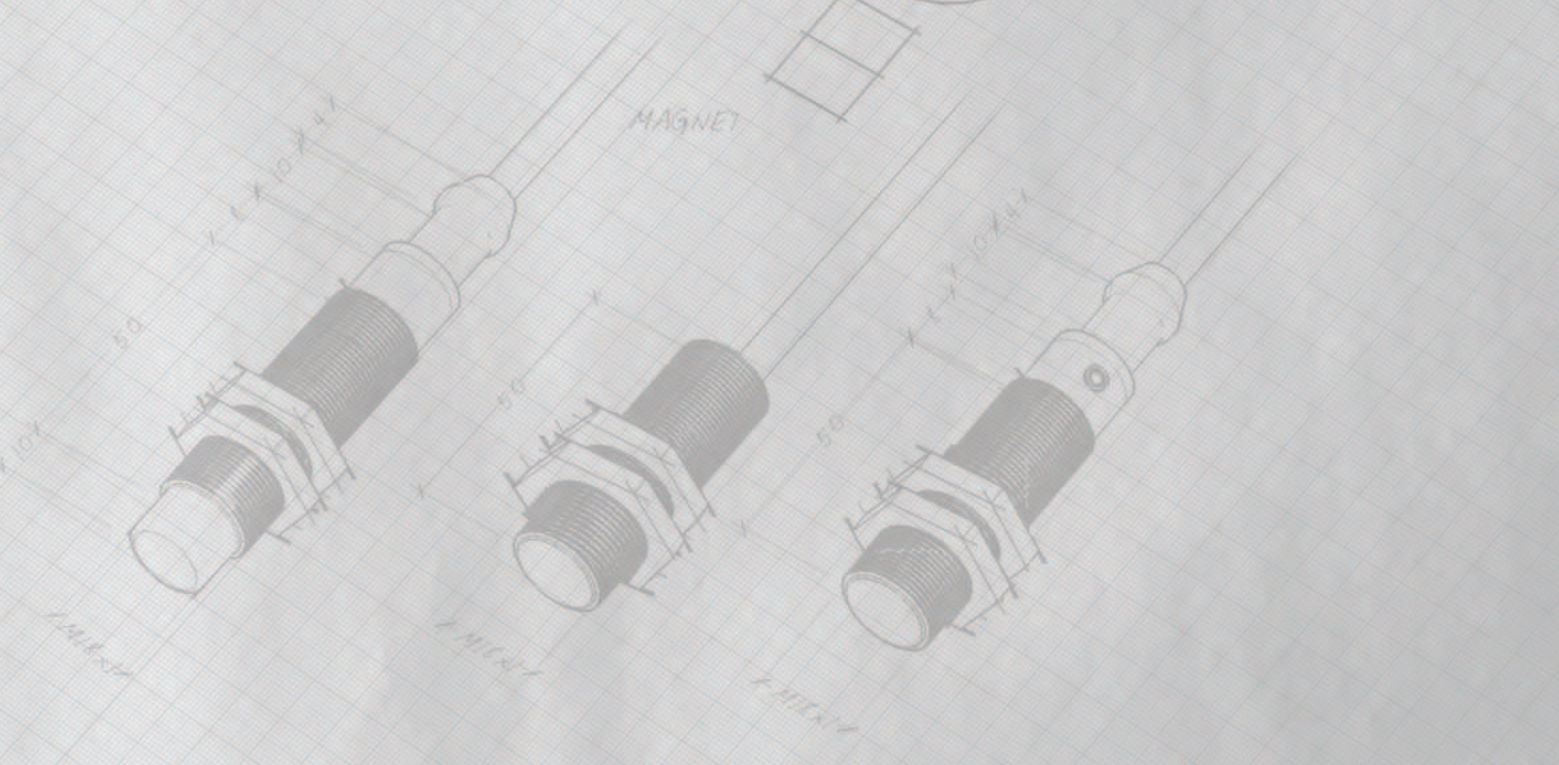
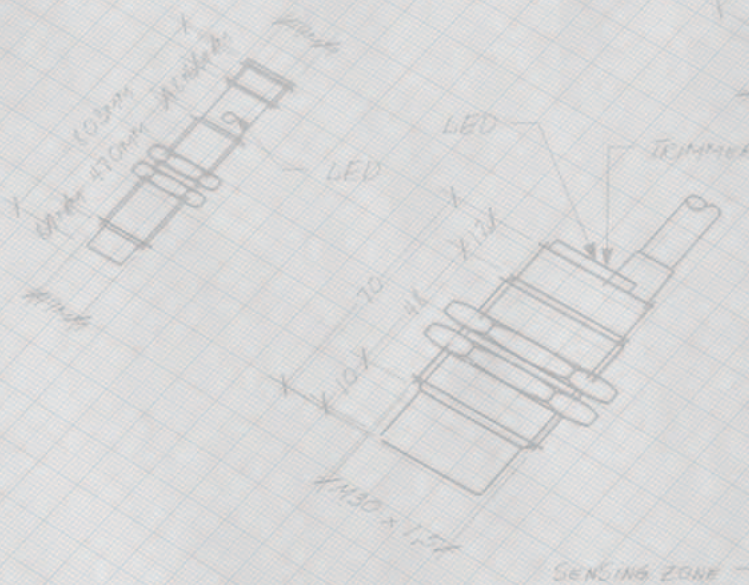
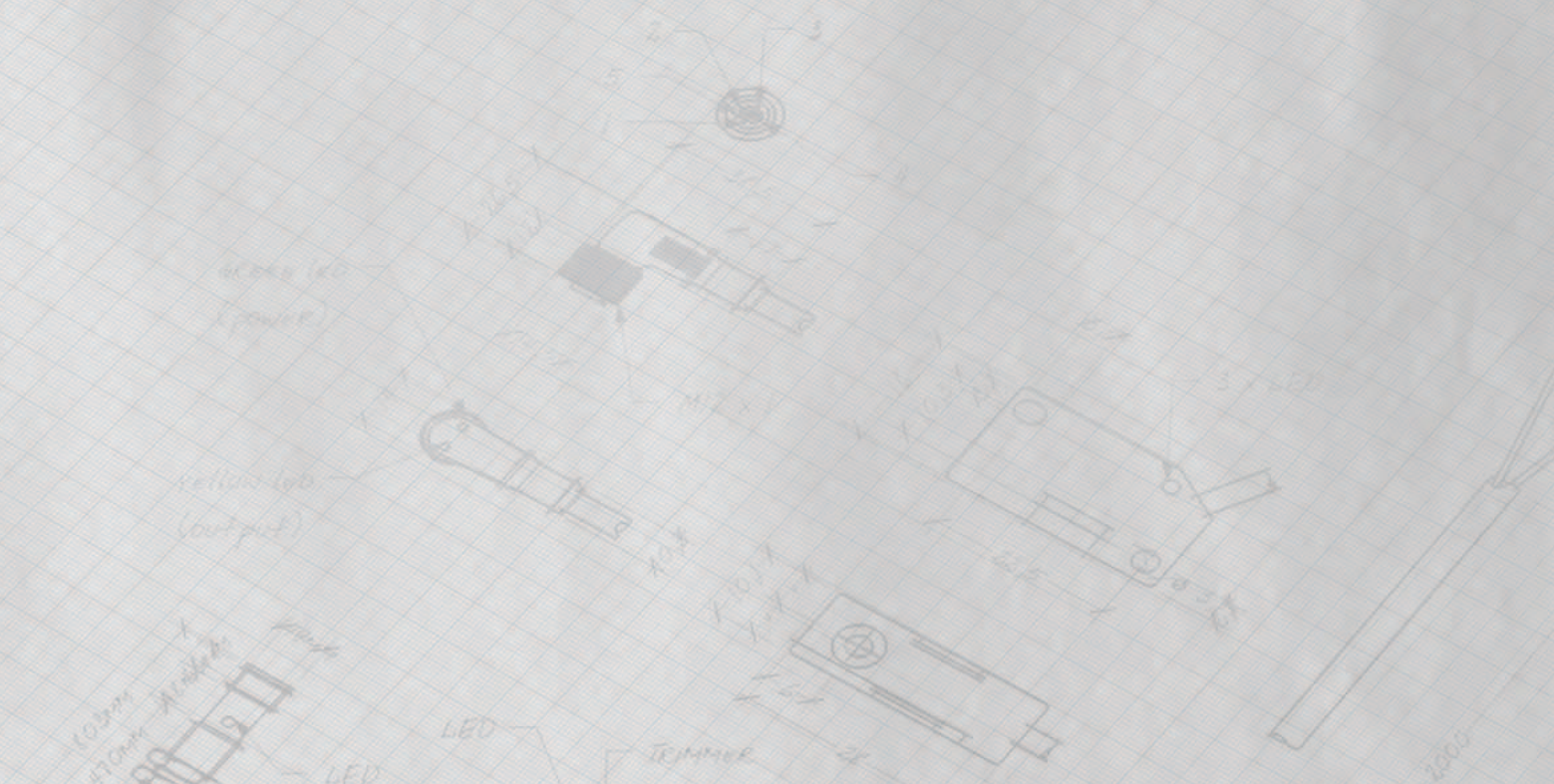

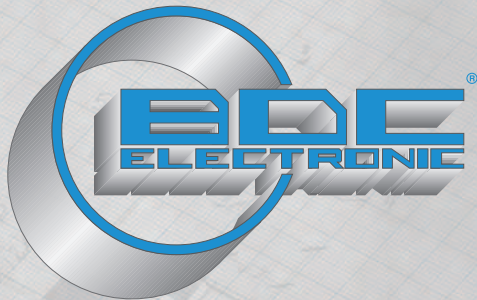

The quality system
BDC ELECTRONIC
is certified according to
standard ISO 9001:2000.

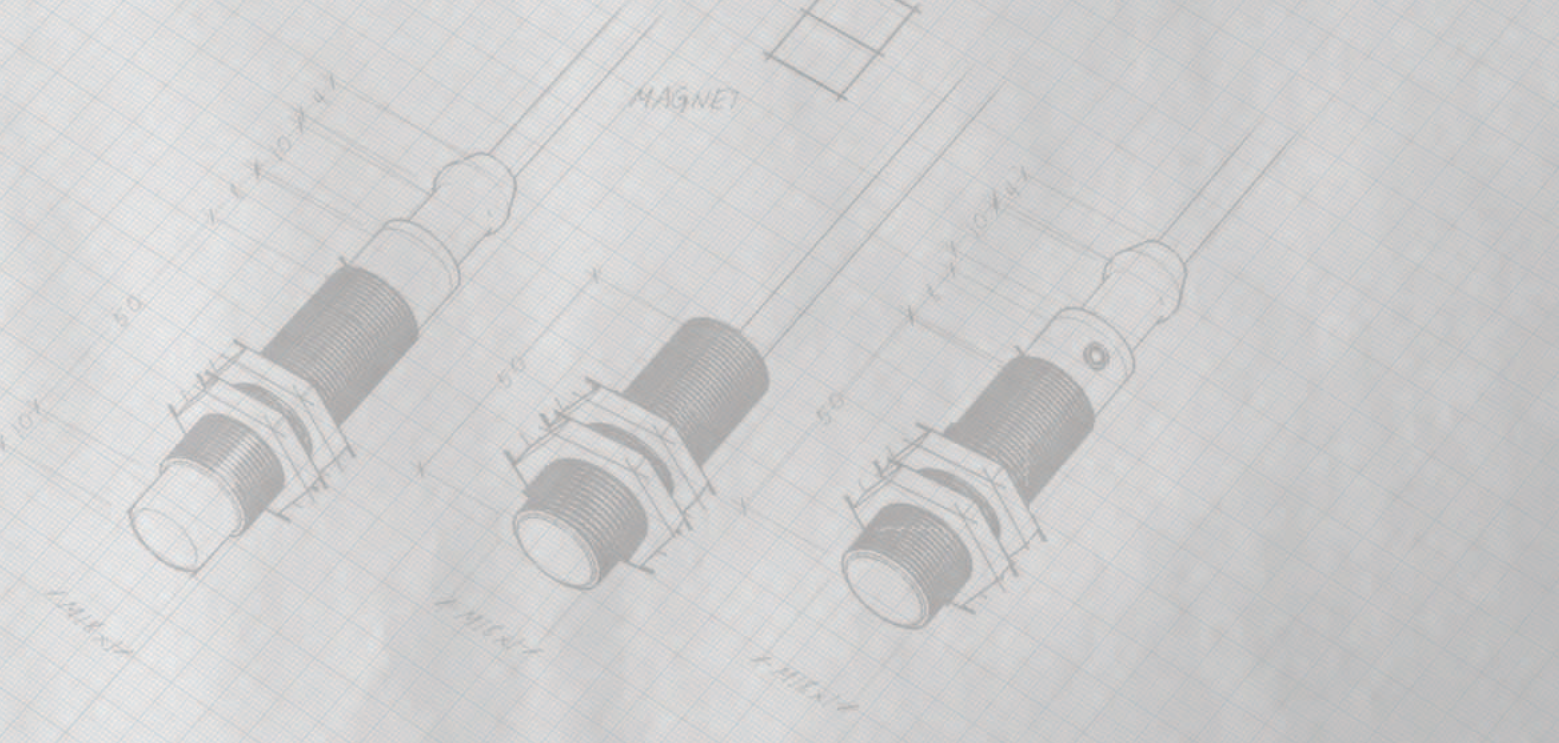
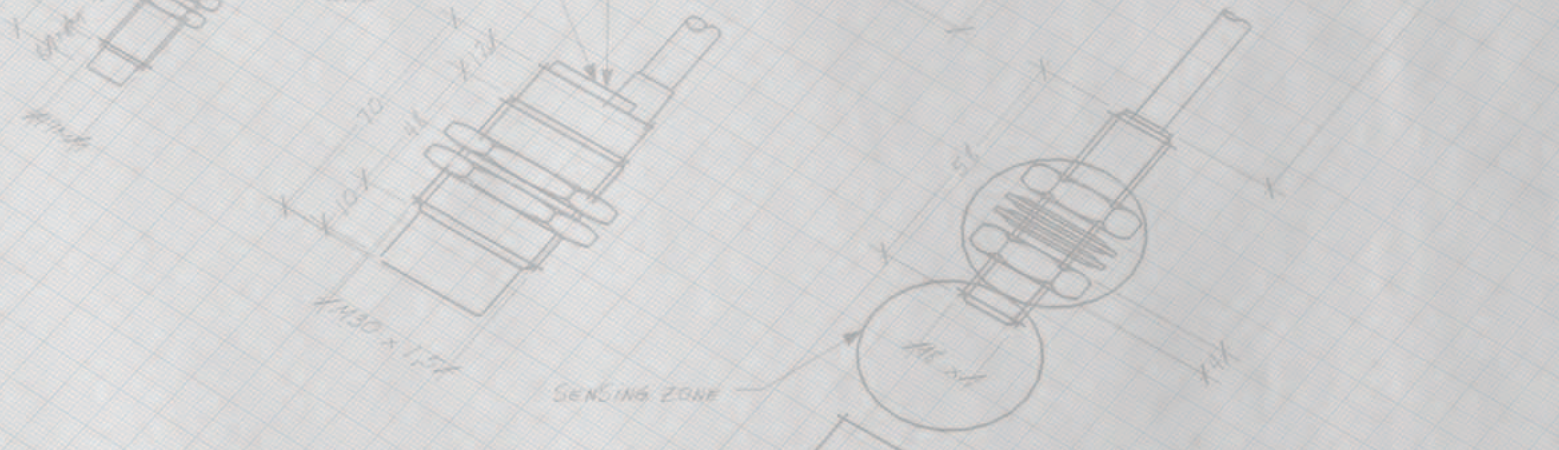
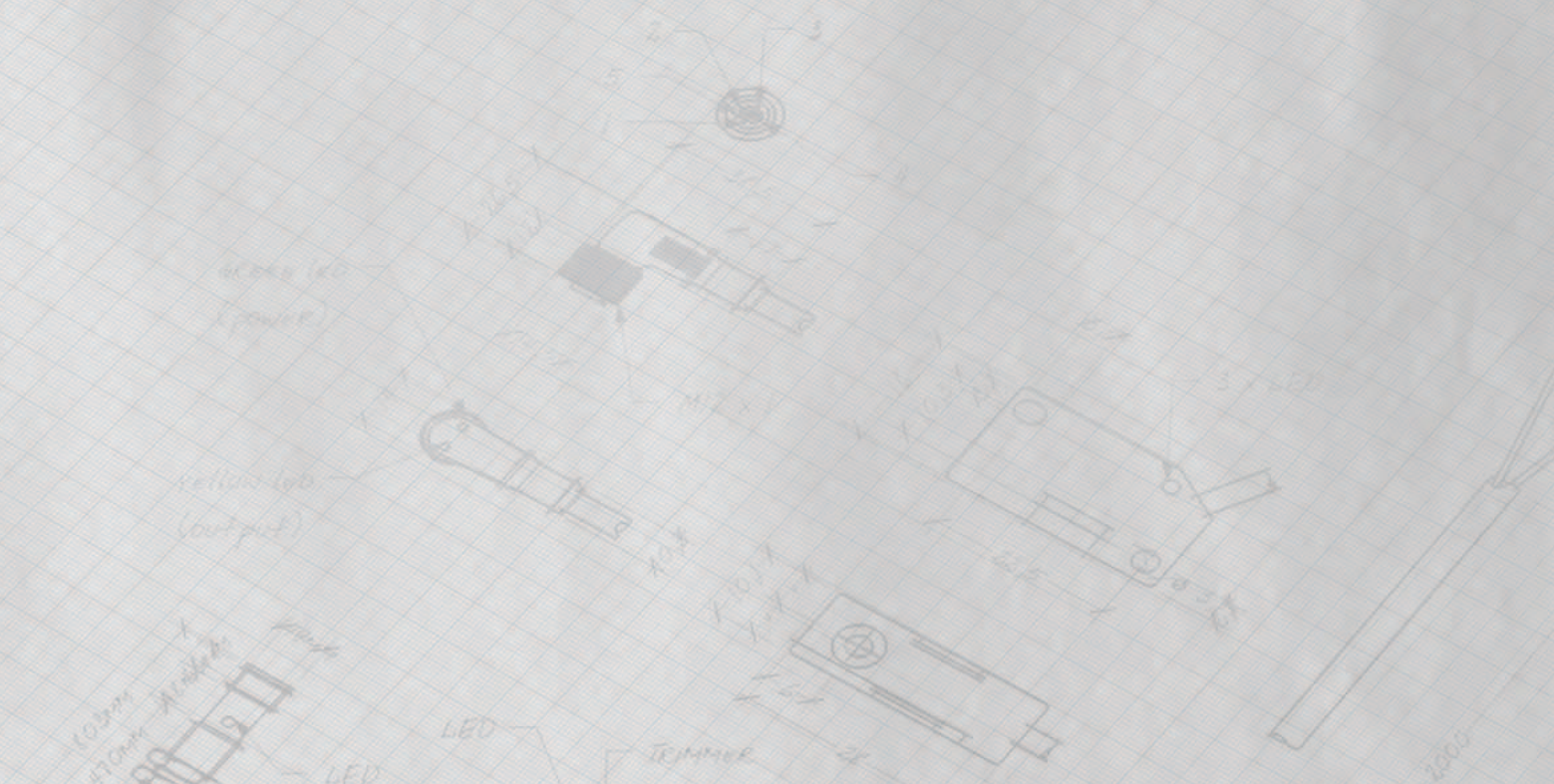

PROXIMITY SENSORS

THE TOTAL QUALITY FOR THE TOTAL PRECISION



INTERNAL
TEST
LABORATORY 

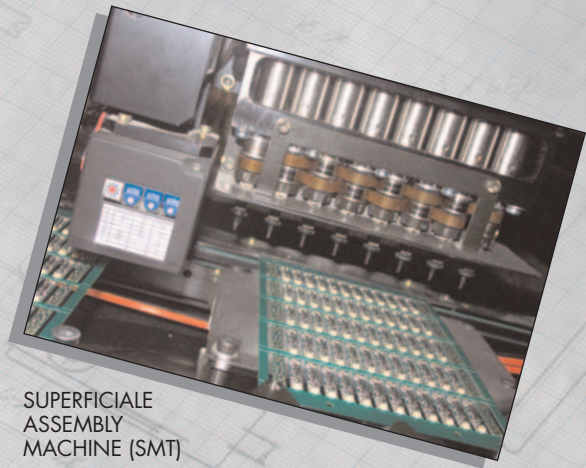

SUPERFICIALE
ASSEMBLY
MACHINE (SMT)

All the **BDC ELECTRONIC** products are tested with the most sophisticated high technology equipment to grant the respect of all the standards.

The productive process is based on the use of high technology machinery which allows the highest control levels for the quality of the finished product.

All the details are built with the maximum accuracy to make the finished product assure the highest standards of functional reliability.

Completely automated processes for every stage assure the creation of a product made to gratify any requirement.

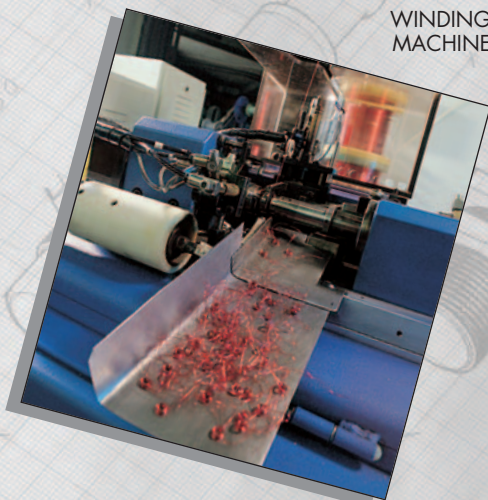

WINDING
MACHINE



RESIN DISPENSING
MACHINE

6000 LED
(power)

yellow led
(output)

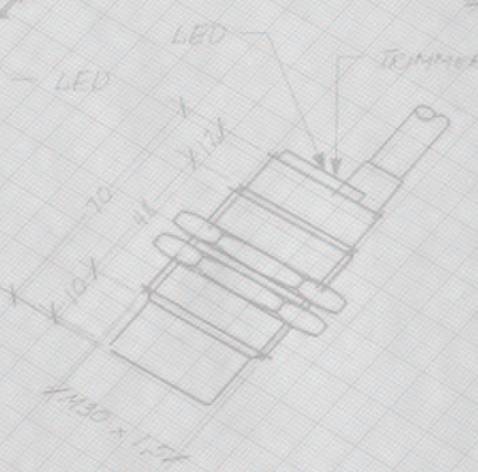

SENSING ZONE

MAGNET

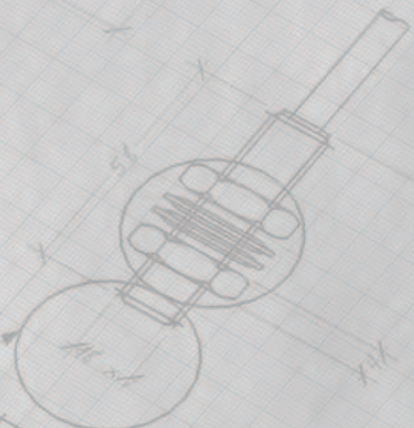
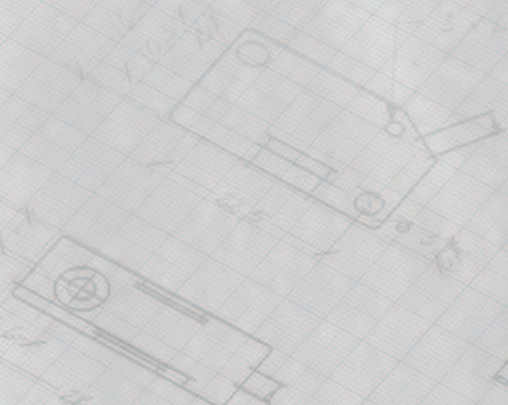
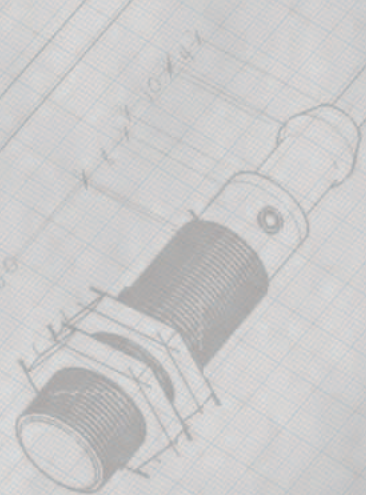
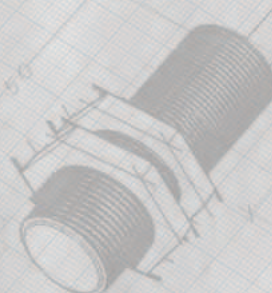
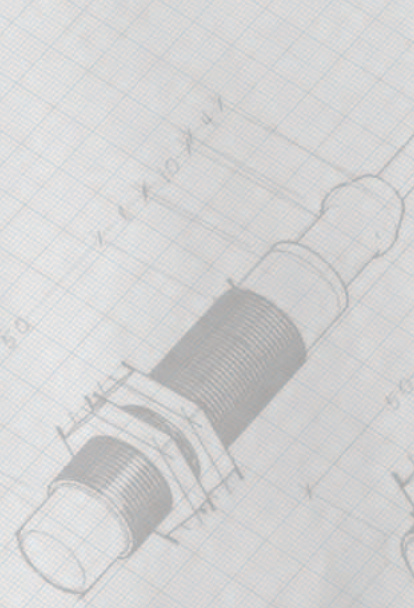

2000

GENERAL INFORMATIONS

Utilization of sensors	pag.	15
Applications	pag.	16
Benefits	pag.	16
Standards	pag.	16
Cable characteristics	pag.	16
Resistance to mechanical shock and vibrations	pag.	17
Degree of protection	pag.	17
Description of the technical terms in the catalogue	pag.	17
Characteristics of the output stages	pag.	19
Mounting precautions	pag.	22

INDUCTIVE SENSORS

General informations	pag.	A-1
How to interpret the ordering references	pag.	A-3

CYLINDRICAL INDUCTIVE SENSORS IN METAL HOUSING

NAMUR SERIES

(DC...)

Cable output	pag.	A-5
Cable output with LED	pag.	A-8
Connector output M8x1	pag.	A-9
Connector output M12x1	pag.	A-10
Connector output M12x1 with LED	pag.	A-11
For high temperatures (-25° ÷ + 110°C)	pag.	A-12



AMPLIFIED IN d.c.

• CENELEC STANDARD	(DCA...)	
Cable output	pag.	A-13
Connector output M8x1	pag.	A-18
Connector output M12x1	pag.	A-19
Connector output C1 - C2	pag.	A-21
• SHORT SERIES	(DSA...)	
Cable output	pag.	A-24
Connector output M8x1	pag.	A-25
Connector output M12x1	pag.	A-26
• EXTENDED SENSING DISTANCE	(DCAE... - DCE...)	
Cable output	pag.	A-27
Connector output M8x1	pag.	A-29
Connector output M12x1	pag.	A-30
• SHORT SERIES WITH EXTENDED SENSING DISTANCE	(DSE...)	
Cable output	pag.	A-32
Connector output M8x1	pag.	A-33
Connector output M12x1	pag.	A-34
• EXTENDED TEMPERATURE RANGE (- 40° ÷ + 85°C)	(DCA...KST)	
Cable output	pag.	A-35
Connector output M12x1	pag.	A-36



CYLINDRICAL INDUCTIVE SENSORS IN METAL HOUSING

- HIGH TEMPERATURES **(DCA...KT)**
 - Cable output (-25° ÷ +125°C) pag. A-37
 - Connector output M12x1 (-25° ÷ +120°C) pag. A-38

- DEGREE OF PROTECTION IP68
 - Cable and connector output M18 x 1 **(DCA...KSJ)** pag. A-39
 - Short series **(DSA...KSJ)** pag. A-40

- 2 WIRES NON POLARIZED **(DCM...)** pag. A-41

- STAINLESS STEEL SENSING FACE **(DCA...MKS)** pag. A-43

- HIGH PRECISION (H<1µm) **(IPS...)** pag. A-44

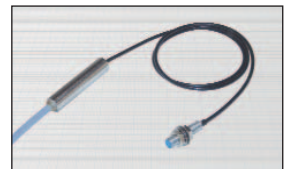

ANALOG LINEAR OUTPUT

- CURRENT OUTPUT (4 ÷ 20 mA o 0 ÷ 16 mA) **(DCAL...)**
 - Cable output pag. A-45
 - Connector output pag. A-47

- VOLTAGE OUTPUT (0 ÷ 10 V) **(DCAL...V)**
 - Cable output pag. A-49
 - Connector output pag. A-50

AMPLIFIED IN d.c. + a.c.

- 5 OUTPUT FUNCTIONS **(DX...)**
 - Cable output pag. A-51
 - Connector output M12 x 1 pag. A-52

- POWER SUPPLY 10 ÷ 50 V ≈ **(AXM...)**
 - Cable output pag. A-53
 - Connector output M12 x 1 pag. A-54

- POWER SUPPLY 20 ÷ 240 V ≈ **(AX...)**
 - Cable output pag. A-55
 - Connector output M12 x 1 pag. A-56



AMPLIFIED IN a.c.

- 2 WIRES **(AC...)**
 - Cable output pag. A-57
 - Connector output M12x1 pag. A-59
 - Connector output C1 - C2 pag. A-61

- 3 WIRES + EARTH **(ACB...)**
 - Cable output pag. A-63

CYLINDRICAL INDUCTIVE SENSORS IN PLASTIC HOUSING

NAMUR SERIES

(DC...P/...)

Cable output pag. A-64

AMPLIFIED IN d.c.

- CENELEC STANDARD **(DCA...P/...)** pag. A-65
- SHORT SERIES **(DSA...P/...)** pag. A-67
- DEGREE OF PROTECTION IP68
CENELEC standard **(DCA...P/...KSJ)** pag. A-68



AMPLIFIED IN a.c.

- CENELEC STANDARD **(AC...P/...)** pag. A-69
- DEGREE OF PROTECTION IP68 **(AC...P/...SJ)** pag. A-70

RECTANGULAR INDUCTIVE SENSORS

TYPE Z

- NAMUR SERIES **(DCZ...)** pag. A-71
- AMPLIFIED IN d.c. 3 wires **(DCAZ...)** pag. A-72
- AMPLIFIED IN d.c. 2 wires non polarized **(DCMZ...)** pag. A-73



TYPE T

- NAMUR SERIES **(DCT...)** pag. A-74
- AMPLIFIED IN d.c. **(DCAT...)** pag. A-75
- AMPLIFIED IN a.c. **(ACT...)** pag. A-76



TYPE X and Y

- NAMUR SERIES **(DCX... - DCY...)** pag. A-77
- AMPLIFIED IN d.c. **(DCA... - DCAY...)** pag. A-78
- AMPLIFIED IN a.c. **(ACX... - ACY...)** pag. A-79



TYPE P - 5 POSITIONS HEAD

- NAMUR SERIES **(DCP...)** pag. A-80
- AMPLIFIED IN d.c. **(DCAP...)** pag. A-81
- AMPLIFIED IN a.c. **(ACP...)** pag. A-82



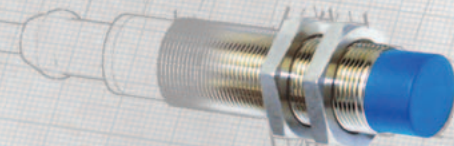

RECTANGULAR INDUCTIVE SENSORS

DIAMETER 80 mm

- NAMUR SERIES (DC80B...) pag. A-83
- AMPLIFIED IN d.c. (DCA80B...) pag. A-84
- AMPLIFIED IN a.c. (AC80B...) pag. A-85

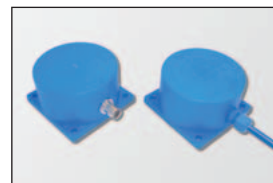

TYPE R - ADJUSTABLE SENSING DISTANCE

- NAMUR SERIES (DCR...) pag. A-86
- AMPLIFIED IN d.c. (DCAR...) pag. A-87
- AMPLIFIED IN a.c. (ACR...) pag. A-88



INDUCTIVE SLOT SENSORS

NAMUR SERIES

(DF...)

- Cable output pag. A-89

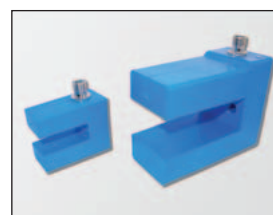

AMPLIFIED IN d.c.

(DCF...)

- Cable output pag. A-90
- Connector output pag. A-91

AMPLIFIED IN a.c.

(ACF...)

- Cable output pag. A-92

CAPACITIVE SENSORS

- General informations pag. B-1
- How to interpret the ordering references pag. B-3

CYLINDRICAL CAPACITIVE SENSORS IN METAL HOUSING

NAMUR SERIES

(NKS...)

- Cable output pag. B-5



AMPLIFIED IN d.c.

(BKS...)

- Cable output pag. B-6
- Connector output M12x1 pag. B-7

AMPLIFIED IN a.c.

(AKS...)

- Cable output pag. B-8

CYLINDRICAL CAPACITIVE SENSORS IN PLASTIC HOUSING

NAMUR SERIES

(NKS...P/...)

Cable output page B-9

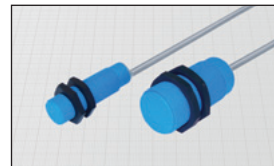

AMPLIFIED IN d.c. 4-wire

(BKS...P/...)

Cable output page B-10

AMPLIFIED IN a.c. 2-wire

(AKS...P/...)

Cable output page B-11

RECTANGULAR CAPACITIVE SENSORS IN METAL HOUSING

WIDE SENSING SURFACE

(BKS7530...)

Connector output page B-12



MAGNETIC SENSORS

General information page C-1

How to interpret the ordering references
(cylindrical and rectangular sensors) page C-2

How to interpret the ordering references
(sensors for pneumatic cylinders with T slot) page C-3

DETECTION OF MAGNETS

WITH REED CONTACT

2-wire **(BMS...)** page C-5

2 and 3-wire with LED **(BMS.../...S)** page C-6

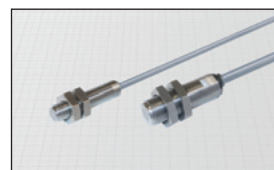

AMPLIFIED IN d.c.

Cable output with LED **(BMS.../...KS)** page C-7

TYPE Z and W

With REED contact 2-wire **(BMSZ... - BMSW...)** page C-8

Amplified in d.c. 3-wire with LED **(BMSZ/...KS - BMSW/...KS)** page C-9

FOR PNEUMATIC CYLINDERS WITH T SLOT

With REED contact 2 and 3-wire with LED **(BMT...2... - BMT...3...)** page C-10

Static output 3-wire with LED **(BMT...9... - BMT...8...)** page C-11



MAGNETS FOR SENSORS **(MAG-...)** page C-12

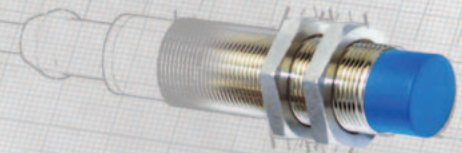

DETECTION OF FERROMAGNETIC TARGET

AMPLIFIED IN d.c. (DCH.../...KS)

Connector output M12x1 pag. C-13

SPEED SENSORS

How to interpret the ordering references pag. D-1

SPEED SENSORS FOR TOOTHED WHEELS

ALIGNED MOUNTING

For teeth ≥ 2 mm(BRS.../...) pag. D-3



NON ALIGNED MOUNTING

For teeth ≥ 5 mm(BRUS.../...) pag. D-4

WITH DOUBLE OUTPUT A + B(BRDS.../...) pag. D-5

SPEED SENSORS WITH INTEGRATED CONTROL

3 wires in d.c.(DSD.../...) pag. D-6



2 wires in a.c.(ASD.../...) pag. D-8

ACCELERATION SENSORS

How to interpret the ordering references pag. E-1



2 AXIS INCLINATION SENSORS

ANALOG VOLTAGE OUTPUT

Cable output(ISX/...) pag. E-3

2 AXIS VIBRATION SENSORS

AVERAGE VALUE OUTPUT

Cable output(VSX/...) pag. E-4

AMPLIFIERS FOR SENSORS

How to interpret the ordering references pag. F-1



OPTOCOUPLED STATIC OUTPUTS

1 or 2 channels **(AM-OP-...)** pag. F-3

1 channel with timer **(AM-TOP-...)** pag. F-4

RELAIS OUTPUTS

1 or 2 channels **(AM-RL-...)** pag. F-5

1 channel with timer **(AM-TRL-...)** pag. F-6

CONNECTORS FOR SENSORS

MALE CONNECTORS WIRED ON SENSORS

How to set the ordering reference pag. G-1



CONNECTORS MOULDED WITH CABLE

How to interpret the ordering references pag. H-1

FEMALE CONNECTORS M8 x 1

Straight in d.c. **(C11...)** pag. H- 3
 Angled in d.c. **(C12...)** pag. H- 4



MALE CONNECTORS M8 x 1

Straight in d.c. **(C8M...)** pag. H- 5

CONNECTORS MOULDED WITH CABLE

FEMALE CONNECTORS M12 x 1

Straight in d.c.	(C10...)	pag. H- 6
Straight in d.c. with LED	(C10/2...)	pag. H- 7
Angled in d.c.	(C8B...)	pag. H- 8
Angled in d.c. with LED	(C8B/2...)	pag. H- 9

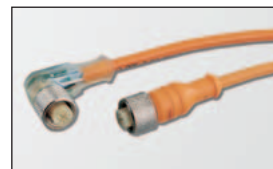

FOR HIGH TEMPERATURES (-40° ÷ + 120°C)

Straight and angled in d.c.	(C10...T - C8B...T)	pag. H-10
-------------------------------------	---------------------	-----------



FOR ATEX SENSORS

Straight in d.c.	(C10...A - C10...3GD)	pag. H-11
Angled in d.c.	(C8B...A - C8B...3GD)	pag. H-12

FOR A.C. SENSORS

3 PIN Straight and angled with double key	(C17... - C18...)	pag. H-13
4 PIN Straight and angled	(C15... - C16...)	pag. H-14

MALE CONNECTORS M12 x 1

Straight in d.c.	(C9...)	pag. H-15
Angled in d.c.	(C9B...)	pag. H-16

MOULDED CONNECTING CABLES

How to interpret the ordering references	pag. I-1
Male M8 x 1 - Female M8 x 1.	(C8M/C11/... - C8M/C12/...) pag. I-3
Male M8 x 1 - Female M12 x 1.	(C8M/C10/... - C8M/C8B/...) pag. I-4
Male M12 x 1 straight - Female M8 x 1.	(C9/C11/... - C9/C12/...) pag. I-5
Male M12 x 1 angled - Female M8 x 1.	(C9B/C11/... - C9B/C12/...) pag. I-6
Male M12 x 1 straight - Female M12 x 1.	(C9/C10/... - C9/C8B/...) pag. I-7
Male M12 x 1 angled - Female M12 x 1.	(C9B/C10/... - C9B/C8B/...) pag. I-8



FIELD ATTACHABLE CONNECTORS

Female straight and angled	pag. I-9
--------------------------------------	----------

INFORMATION TRANSPORT

FIXED CODE IDENTIFICATION SYSTEM

ERB 1	pag. L-1
-----------------	----------



UTILIZATION OF SENSORS

More detailed explanations on the catalogue, at the beginning of each section.

INDUCTIVE SENSORS

Detection of metal objects

Advantages:

- Low cost
- Complete insensitivity to dust, grease, water, non-metal materials

CAPACITIVE PROXIMITY SENSORS

Detection of metal and non-metal objects

Advantages:

- Possibility to adjust the switching point
- Insensitivity to dust on the sensing area (in limited quantity)

MAGNETIC SENSORS

Detection of external magnets

Advantages:

- Very low cost
- High sensing distances with very small sensors
- High resistance under pressure

Detection of ferromagnetic objects

Advantages:

- Insensitivity to non ferromagnetic metals (aluminium, brass, copper, gold, silver...)

SPEED SENSORS

Detection of toothed wheels or holes

Advantages:

- Small teeth detection
- High switching frequency
- Very rugged construction
- High resistance to high temperatures and pressure
- Possibility of speed and direction detection with the same sensor
- Versions with integrated control and self-teaching thresholds

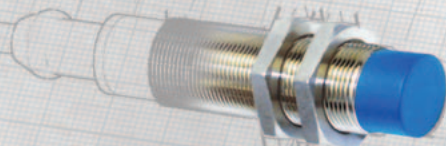

APPLICATIONS

Proximity switches can be used in many control functions and in particular they can operate even in the hardest conditions for any type of mechanical switch. The most frequent applications are:

- Limit switch without contact
- Detection of working pieces
- Sequence detection
- Detection of rotating or sliding speed
- Incremental encoder function (2 sensors with 90° out of phase signals)
- Measurements of thickness and waviness of metallic sheets (linear sensors)
- Detection of materials and alloys composition (linear sensors)

BENEFITS

The use of proximity sensors solves all the difficult problems of automation and detection in industrial and automotive places.

Compared to traditional mechanical micro-switches, they offer more advantages:

- No physical contact is required for operation
- Elimination of contact oxidation, being only electronic components
- No sparking of contacts; types in execution  can work in places with explosive gas or inflammable liquids and solvents evaporations
- Impermeableness against liquids, oils, powders, thanks to the resin clad
- High resistance against vibrations and impacts
- Very long life time thanks to non-electromechanical circuits
- No bounces on the switching edges
- Possibility of direct connecting to logical circuits and counters
- Unlimited life time non depending by the number of cycles

STANDARDS

Conformities

In accordance with the European Directives 2004/108/EC and 2006/95/EC, all products are in accordance with the rules for electromagnetic compatibility and safety standards for the low voltage machinery. These standards are met in accordance with EN60947-5-2.

Namur Sensors non-amplified

The non-amplified d.c. sensors are built according to EN60947-5-6 standards.

Amplified sensors

The amplified d.c. types (DCA and AC types) are manufactured according to EN60947-5-2.

ATEX sensors

For potentially explosive atmosphere applications a wide range of sensors is available certified according to the ATEX directive 94/9/EC. Please refer to the specific catalogue.

CABLE CHARACTERISTICS

All the standard sensor cables are produced of flexible PVC type with flammability resistance according to CEI 20-22 II - IEC 332.3A, with these characteristics:

- conductor formation according to VDE 0295 class 6
- insulation: PVC flammability resistance
- sheath: YM2 flammability resistance to VDE 0209/3.69

The standard cable length is 2 metres, however it is possible on request to have different cable lengths. It is also possible to have BDC sensors with PUR (polyurethane cable) sheath, particularly safe against oils, acids or continuous stress. The cables can also be supplied with insulation and thermoplastic elastomer sheath (TPE-O) for temperatures from - 40° up to +140° C (sensors for high-low temperatures).

RESISTANCE TO MECHANICAL SHOCKS AND VIBRATIONS

Shock by EN 60068-2-27

- Max acceleration: 50 gn
- Impulse time: 11 ms

Vibrations by EN 60068-2-6

- Frequency range: 10 ÷ 55 Hz
- Width: ± 2 mm.

DEGREE OF PROTECTION by EN60529

- IP 65: spouting water from all directions.
- IP 67: immersion for 30 min. in 1 m. depth of water
- IP 68: extended immersion in water at conditions agreed between user and manufacturer.
Please contact our technical office for further details.

DESCRIPTION OF THE TECHNICAL TERMS IN THE CATALOGUE

RATED OPERATING DISTANCE (S_n)

The rated operating distance is a conventional quantity used to designate the operating distance. Manufacturing tolerances and external factors are not taken in account. In fig. 1 we can see the relation between the operating distance (S_n, S_r, S_u) and the hysteresis (H).

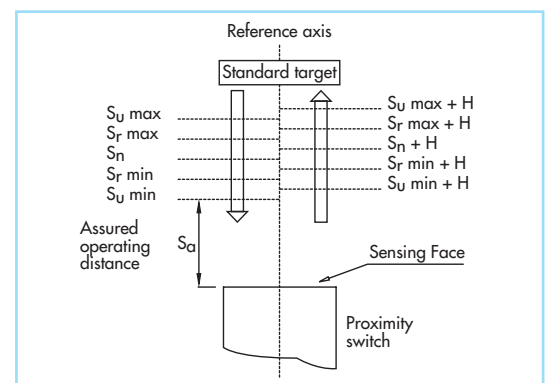

Fig. 1

STANDARD TARGET

The target used for the distance survey is built with an FE360 square steel sheet 1mm thick and on the side it is like the diameter of the circle on the active surface of the sensing face, or either three times the rated operating distance S_n if this is more than the diameter. If the object to survey is of a different material, you can have the rated operating distance by multiplying the effective operating distance (S_r) by one of these reduction factors:

Inductive Sensors

- stainless steel 0,3 ÷ 0,4
- brass 0,35 ÷ 0,50
- aluminum 0,35 ÷ 0,50
- copper 0,25 ÷ 0,45

Capacitive Sensors

- metal 1
- water 1
- PVC 0,5
- wood 0,25
- clothes 0,15
- paper 0,1

These reductions are not valid for the slot types, on which the switching point is almost independent by the metal used.

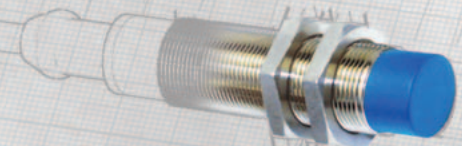

REAL OPERATING DISTANCE (S_r)

The real operating distance is measured with rated voltage and with a temperature of $23 \pm 5^\circ\text{C}$. It must be between the 90% and 110% of the rated operating distance (S_n):

$$0,9 S_n \leq S_r \leq 1,1 S_n$$

ASSURED OPERATING DISTANCE (S_a)

It represents the safe sensibility distance considering the constructive tolerances and the voltage and temperature changes. For the inductive proximity switches the assured operating distance is between 0 and 81% of the rated operating distance (S_n):

$$0 \leq S_a \leq 0,81 S_n$$

For the capacitive proximity switches the assured operating distance is between 0 and 72% of the rated operating distance (S_n):

$$0 \leq S_a \leq 0,72 S_n$$

DIFFERENTIAL TRAVEL OR HYSTERESIS (H)

The differential travel is the difference between the switch-on point and the switch-off point with an axial motion of the target. It's given as a percentage of the effective operating distance (S_r) with a temperature of $23 \pm 5^\circ\text{C}$ and is shown in the tables. That value is never over the 15% of the effective operating distance (S_r).

REPEAT ACCURACY (R)

The repeat accuracy (R) is the maximum variation, in percentage, of the effective operating distance (S_r) performing several switching cycles in 8 hours with a temperature of $23 \pm 5^\circ\text{C}$ and power supply changes of $\pm 5\%$. The differences between any measures is never higher than the 10% of the real operating distance:

$$R \leq 0,1 \cdot S_r$$

MAX SWITCHING FREQUENCY (f)

The max switching frequency specified in the tables of the products, is measured according to fig. 2.

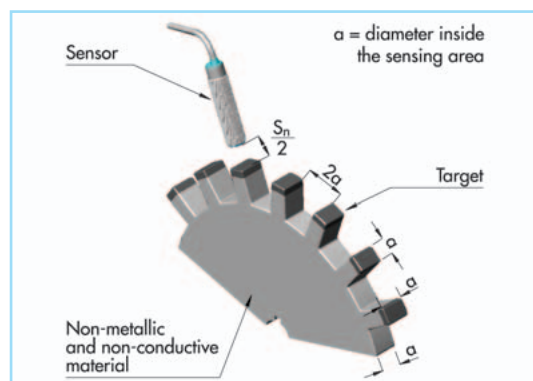

Fig. 2

OPERATIONAL VOLTAGE (U_B)

It's the voltage range where is ensured the proper working of the device. It includes ripples and oscillations.

VOLTAGE DROP (U_d)

It's the voltage measured at the end of the active output of the sensor when it is in on condition at the rated operational current (I_a).

RATED OPERATIONAL CURRENT (I_e)

It's the load current which the sensor can withstand in all temperature and operational voltage range.

OFF-STATE CURRENT (I_r)

It's the current which flows through the 2 wire amplified sensors in off condition. It is recommended to check that this current doesn't exceed the minimum activation current of the load.

MINIMUM OPERATIONAL CURRENT (I_m)

It's the minimum current needed for a proper working of the 2 wire amplified sensors in on condition.

IMPULSE WITHSTAND VOLTAGE

All sensors are protected against the overvoltages coming from the supply line or from the load. The minimum value is 1KV and is tested according to EN60947-5-2 standards.

CHARACTERISTIC OF THE OUTPUT STAGES

NON AMPLIFIED IN d.c. NAMUR SERIES

The sensors of this series contain only the oscillator stage and an output filter. This allows the reduction of space and costs. Thanks to a small number of components and being used with low currents, these sensors ensure a very high reliability. The driving of a load is possible using them with a proper amplifier (AM... series. See section G) or connected to equipment with specific input stage for NAMUR devices.

ATEX sensors category 1G - 1D must be used with associated apparatus with ATEX certification.

Working:

With references to fig. 3, apply U_n between 5 and 30 Volts: the I current flows through the sensor crossing the R_x resistance giving the V_o voltage. The current value will decrease in proportion to how a metal approaches its sensible surface, following the characteristic curve shown.

With V_o voltage we can control a trigger stage having then an exact switching point and giving an ON/OFF output. For the scaling of R_x look the table below:

U_n (V)	R_x (Ω)
5	390
8,2	1000
12	1800
24	3900

It's important to consider that the NAMUR rules recommend the applications of these sensors in a supply range between 7,7 and 9 Vdc with an R_x of 1000 Ω .

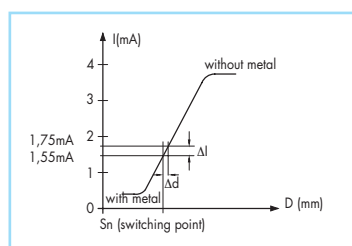
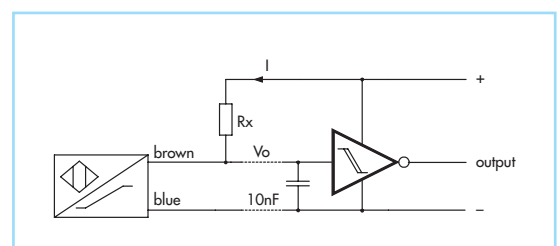
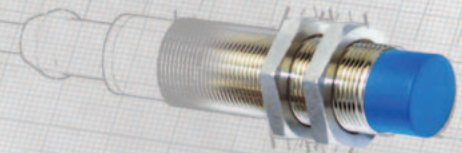

Fig. 3



NAMUR WITH LED SERIES

This series has a LED for the output condition and thanks to the integrated trigger, it has an exact switching point which permits to control PLC inputs and direct loads up to 10 mA without any interface module.



AMPLIFIED SERIES IN d.c. with 3 or 4 wires

The sensor of this series implements a power output stage and the outputs protection (only K versions). They are suitable for direct driving of typical devices such as relays, PLC, contactors.

OUTPUT LOGIC

The choice for the output logic (NPN or PNP) depends on the connection type of load.

The typical output stages are shown in fig. 4. Open collector versions are available upon request.

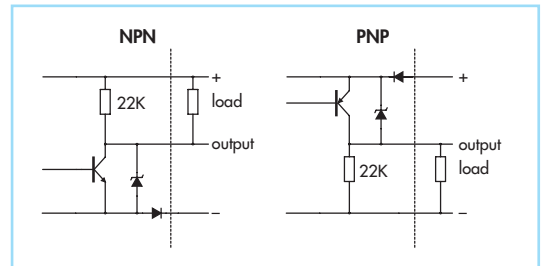

Fig. 4

PROTECTION AGAINST SHORT CIRCUIT

For the "K" version sensors, there is a protection against short circuits and overload in output. This protection starts to work at a value just a bit higher than the rated operational current, stopping the current until there is an excessive absorption. On d.c. sensors the sensor restarts to work as soon as the fault condition is removed. On a.c. sensors the power supply must be taken off in order to reset the protection stage. In some cases the protection can start because of the high capacitive loads, like filter capacitors higher than 100 nF or either lamps. In this case we recommend to use our specific proximity switches.

SERIES CONNECTION: AND LOGIC

With this connection the load is powered only when all switches are closed. The number of switches which can be connected in this way is limited by three factors:

- 1) from the residual voltage drop typical of selected switch, which is 2,2V (max for some types) at maximum load current;
- 2) from the maximum load current of switches employed, because it's important to consider that the self consumption of each sensor must be added to the final load.
- 3) from the delay time of availability. For each sensor there can be a maximum delay of 30 ms. which has to be multiplied for the number of sensors used.

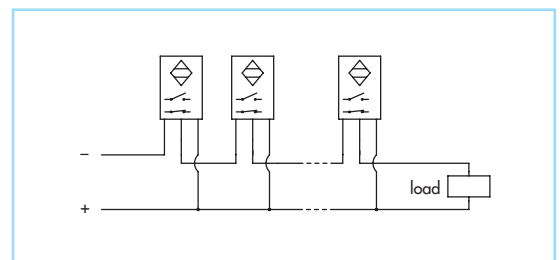

Fig. 5
Example of series connection with NPN sensors.

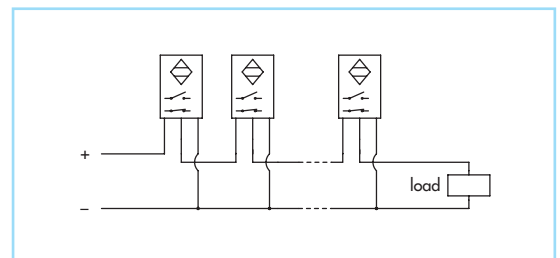

Fig. 6
Example of series connection with PNP sensors.

PARALLEL CONNECTION: OR LOGIC

With this type of connection, the load is powered whenever any of the switches is closed (or its output is conducting). In switches which are parallel connected, it must be considered that every connected sensor is loaded by other sensors internal resistor (collector resistor RC). It is possible to avoid this, using open collector types, or putting some de-coupling diodes as shown in fig 7-8.

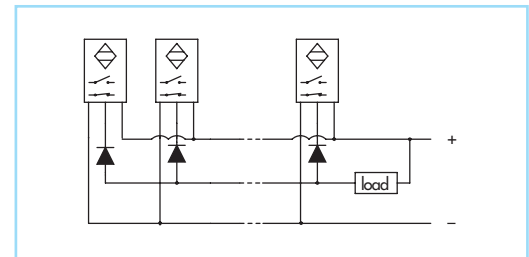

Fig. 7

Example of parallel connection with NPN sensors.

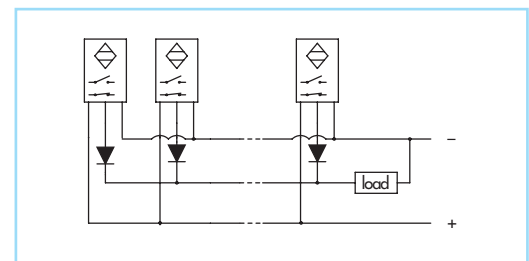

Fig. 8

Example of parallel connection with PNP sensors.

AMPLIFIED SERIES IN d.c. or a.c.

They are connected in series to the load like electro-mechanical micro-switches. It's important to verify that, subtrahend the voltage drop (U_d) by the supply voltage (U_b), there is enough voltage on the load for a correct working. Another important factor in this sensor is the minimum operational current (I_m), below which the sensor doesn't work properly. In open conditions, there will always be a Off-state current (I_r) which will go across the load: make sure that the current isn't enough to keep the load active. If this would happen it will be necessary to connect a resistance in parallel to the load itself.

SERIES CONNECTION: AND LOGIC

If several sensors must be connected in series, it is necessary to verify that summing all sensor voltages drop the load continues to have sufficient voltage for the correct working. We must also consider that in the open condition the supply voltage is divided by the number of sensors: make sure that on each sensor there is a voltage not lower than minimum value of U_B .

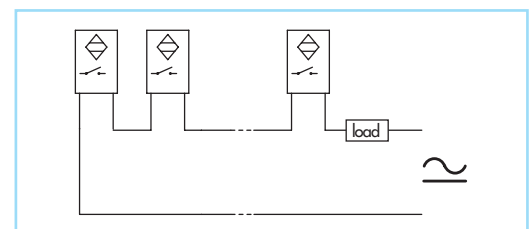

Fig. 9

Example of series connection with 2 wires amplified sensors.

AMPLIFIED SERIES IN a.c. 3 wires + earth

This series of sensors (ACB, ACBF) is suitable to solve minimum load, residual current and voltage drop problems typical on 2 wires series. They've got two wires for supply, one for the output and one for the earthing.

Their connection is similar to the amplified models in d.c. (fig. 10).

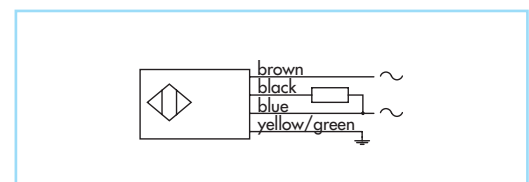
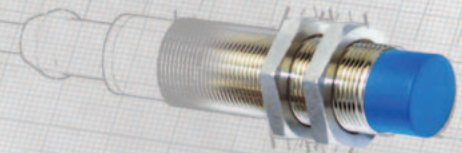

Fig. 10



MOUNTING PRECAUTIONS

Although sensors are made to resist to the most difficult use conditions, anyway we recommend you:

- not to wire sensors connections along with power conductors. Use of separated raceways is recommended.
- never exceed the maximum of the fixing torque recommended for the nuts fixing. Bear in mind in addition that the threaded zone next to the sensible head is less resistant than the rest of the body.
- make sure the product doesn't touch corrosive agents, oils, aggressive solvents, etc. Call our technical office to have further informations about the resistance of materials to the various substances.
- avoid shocks and abrasive actions on the sensible part of the sensors: this one represents the most fragile zone of the device.
- connect a high-speed fuse with appropriate value in series with the circuit if you use sensors without protection against short circuit.

CYLINDRICAL SENSORS

Totally shielded: flush mounting

Sensors are not influenced by surrounding metals. However it's recommended to keep a distance between sensors placed side by side to avoid interferences. If this isn't possible, it's recommended the use of sensors with differentiated frequencies for mounting in line.

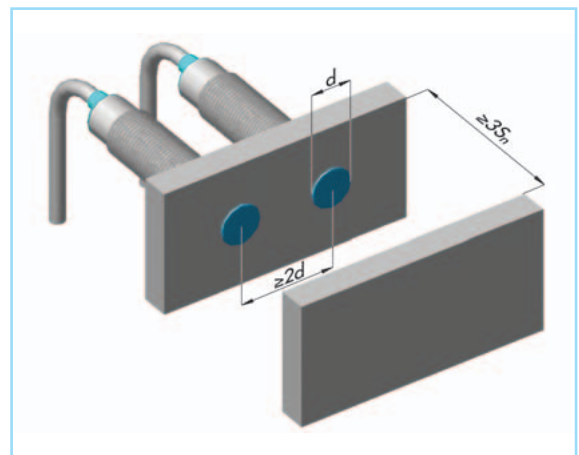

Unshielded: non flush mounting

Sensors can be influenced by surrounding metals. A distance $\geq 3d$ between a sensor and another is needed. For extended sensing distance versions a distance at least $\geq 4d$ is recommended.

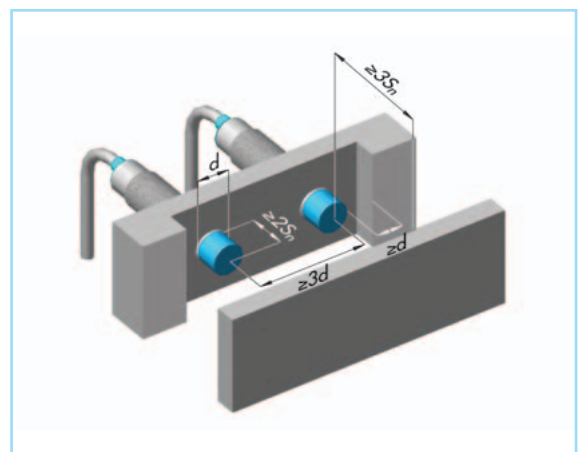

Extended sensing distance and stainless steel sensing face versions: quasi flush mounting

These sensors, because of their high sensitivity, are slightly sensitive to surrounding ferromagnetic metals which can bring down their sensing distance. To avoid this effect it's advised to keep the sensor a little out from the plain for a length (L) indicated in the chart.

Sensor diameter (mm)	L
6,5 - 8	1,5
12	2,4
18	3,6
30	8

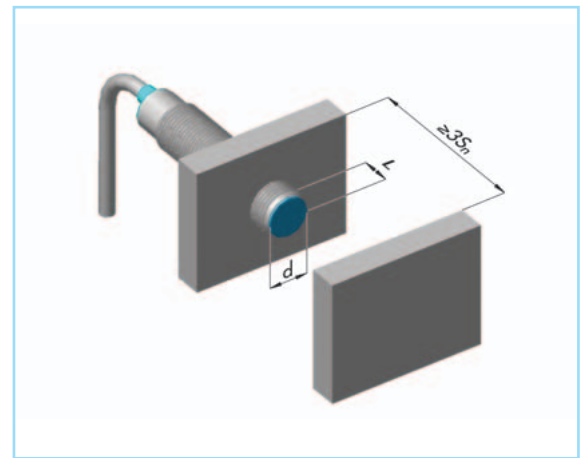

Opposed mounting of two sensors

A security distance of 10 S_n avoids interferences between electromagnetic fields.

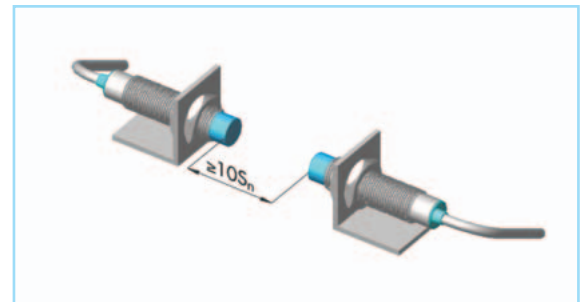

RECTANGULAR SENSORS

Totally shielded: flush mounting

Sensors are not influenced by surrounding metals. However it's recommended to keep a distance between sensors placed side by side to avoid interferences. If this isn't possible, it's recommended the use of sensors with differentiated frequencies for mounting in line.

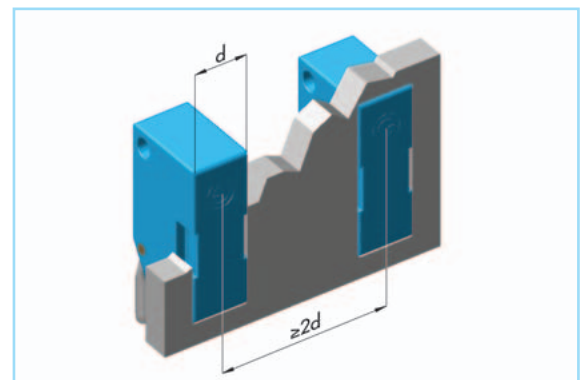

Unshielded: non flush mounting

Sensors can be influenced by surrounding metals. It's necessary to have more space between a sensor and the other.

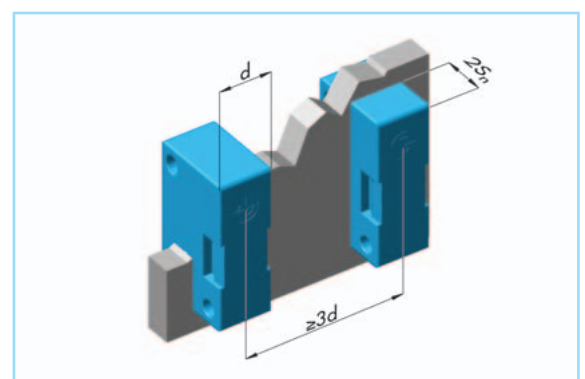

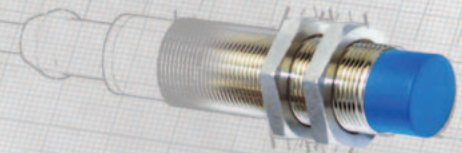

Opposed mounting of two sensors

A safety distance of $10 S_n$ avoids interferences between electromagnetic fields.

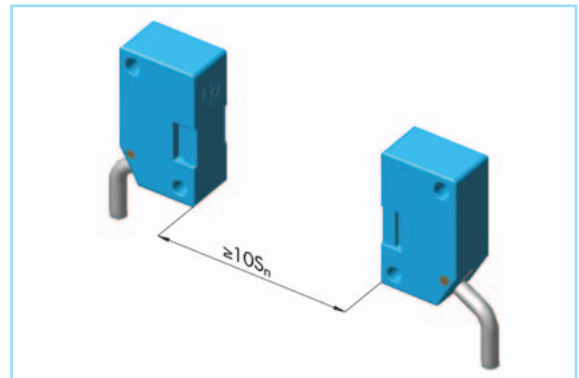

SLOT SENSORS

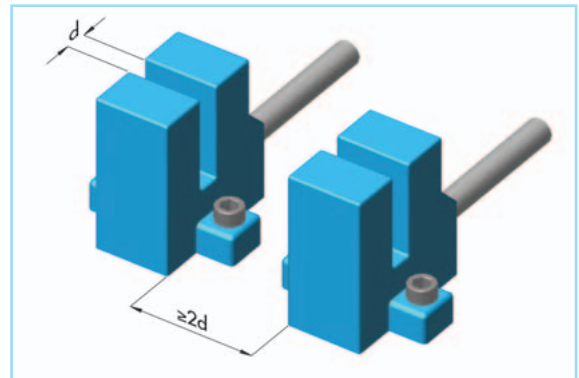

It's recommended to keep a distance of twice the gap (d).

PROXIMITY SENSORS



INDUCTIVE SENSORS

Inductive sensors detect the presence of metal objects presence in the sensible area. They aren't influenced by non-metal materials.

WORKING PRINCIPLE

An oscillating electromagnetic field is generated in the sensible area. When a metal object enters the sensitivity field, it tends to decrease the amplitude of oscillation, creating in this way a switching in the output stage.

In inductive sensors range there are version with linear output in current or in voltage.

In these sensors the presence of metal objects is detected and turned into a signal proportional to the damping of the oscillator, which depends by the distance and metallic composition of the detected object.

INDUCTIVE SENSORS

- IPS** = high precision ($H < 1 \mu\text{m}$)
- AC** = amplified a.c. 2 wire cylindrical body inductive series
- ACB** = amplified a.c. 3 wire cylindrical body inductive series
- ACF** = amplified a.c. 2 wire slot inductive series
- AX** = amplified a.c. + d.c. 2 wire 20 ÷ 240 V
- AXM** = amplified a.c. + d.c. 2 wire 10 ÷ 50 V
- DC** = cylindrical inductive NOT amplified d.c. NAMUR series 2 wires
- DCA** = cylindrical inductive amplified d.c. 3-4 wires
- DCAL** = cylindrical inductive analog linear output
- DCE** = extended sensing distance d.c. series
- DCF** = amplified d.c. slot series
- DF** = inductive slot sensors NOT amplified d.c. NAMUR series
- DSA** = amplified d.c. cylindrical SHORT body inductive series
- DSE** = extended sensing distance d.c. SHORT series
- DX** = amplified d.c. 2 wire 5 function series
- DCM** = amplified d.c. 2 wire non polarized

Diameter of cylindrical sensor or slot width for slot types.
For other types, change the number with the following:

- 80B** = diameter 80 mm
- P** = rectangular plastic 5 positions head 40 x 40 x 112
- R** = rectangular plastic with adjustable sensing distance 100 x 111 x 30
- T** = rectangular plastic 25 x 40 x 12
- X** = rectangular plastic 25 x 50 x 10
- Y** = rectangular plastic 30 x 50 x 15
- Z** = rectangular plastic 16 x 28 x 10

P = plastic housing

4 = flush mounting

5 = non flush mounting

DCA	18	P/	4	7	0	9	KS	-5	PUR
------------	-----------	-----------	----------	----------	----------	----------	-----------	-----------	------------

- 0** = with connector n° 17 - 18
- 1** = with connector n° 15 - 16
- 2** = 90° output with connector n° 1
- 3** = with connector M12 x 1
- 4** = with connector n° 1
- 6** = standard type cable output
- 7** = cable output with sheath holder
- 8** = with gland
- 9** = with connector M8 x 1
- A** = body length 50 mm completely threaded
- E** = with connector n° 2
- L** = side cable output
- *** = male connector wired on the sensor (see pag. H-1)

- 0** = NO (normally open output)
- 1** = NC (normally closed output)
- 2** = NO + NC (complementary outputs)
- C** = NC (output normally closed on pin 2 of connector)
- 5** = 5 functions sensor

- 0** = NAMUR series with 2 wires
- 8** = NPN
- 9** = PNP
- 9** = 20 ÷ 240 V. for a.c. sensors
- X** = 5 functions sensor

- L** = smooth body
- M** = stainless steel sensing face
- J** = degree of protection IP68
- K** = protection against short circuit and overload
- S** = LED output status
- T** = high temperature version
- V** = linear sensor with voltage output

Cable length (if required different than standard 2m)

For Polyurethane cable add PUR

NAMUR SERIES - diameters 4 - 5 - 6,5 - 8 - 12 mm •
Non amplified in d.c. 2 wires •
Cable output •

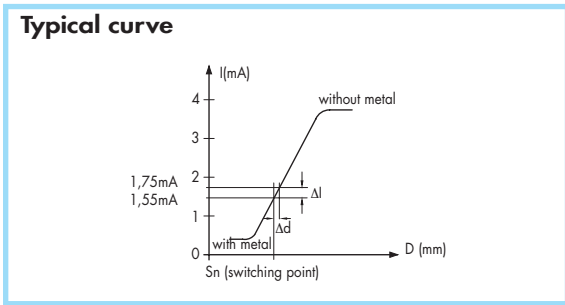
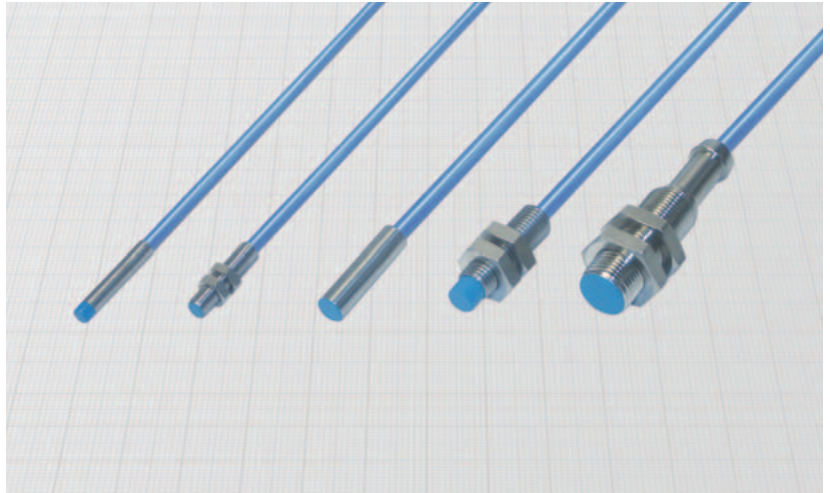
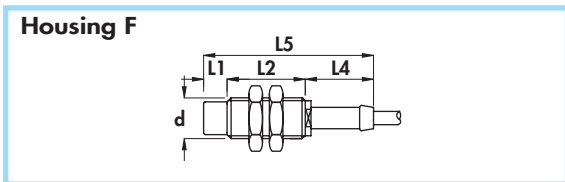
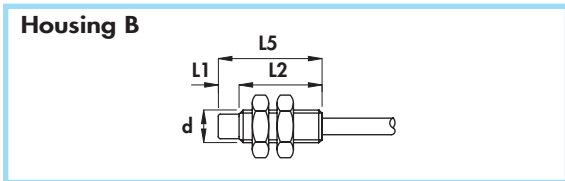
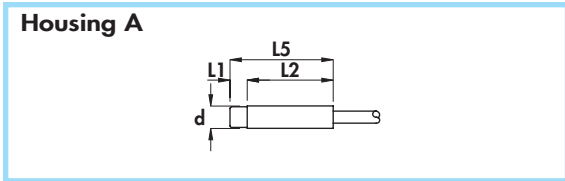

Diameter	M5 x 0,5	M8 x 1	M12 x 1
Nut	Size	SW7	SW13
	Thickness mm	2,5	4
Max tightening torque Nm	2	10	15

- Materials:**
- Cable: 2 m PVC CEI 20 - 22 II; 90°C; 300 V; O.R.
 - Housing 4 - 5 - 6,5 - 8 mm: stainless steel
 - Housing 12 mm: nickel plated brass
 - Sensing face: plastic

Technical data:

- Working voltage: 5 ÷ 30 Vdc
- Supply voltage according to NAMUR: 7,7 ÷ 9 Vdc
- Max ripple: 10%
- Consumption at 8,2 V with Rx = 1000 Ω
 - with metal: ≤ 1 mA
 - without metal: ≥ 3 mA
- Temperature range: -25° ÷ +70°C
- Max thermal drift of sensing distance S_i: ± 10%
- Repeat accuracy (R): 2%
- Degree of protection: IP67
- Cable conductor cross section:
 - 0,15 mm² on 4 and 5 mm
 - 0,35 mm² on 6,5 ÷ 12 mm
- According to EN60947-5-6
- Electromagnetic compatibility (EMC) according to EN60947-5-2
- Shock and vibration resistance according to EN60068-2-27 EN60068-2-6
- For certified ATEX version see ATEX Catalogue

Housing	Flush mounting Non flush mounting	L1	L2	L3	L4	L5	Cable diameter	Body diameter (d)	Max switching frequency (f)	Nominal sensing distance (S _i) ± 10%	ORDERING REFERENCES
		mm	mm	mm	mm	mm					
A	•	-	20	-	-	20	3	4	5	0,8	DC4/4600L
B	•	-	20	-	-	20	3	M5 x 0,5	5	0,8	DC5/4700
A	•	-	25	-	-	25	4	6,5	5	1,5	DC6,5/4700L
A	•	5	20	-	-	25	4	6,5	3	2,5	DC6,5/5700L
A	•	-	25	-	-	25	4	8	5	1,5	DC8/4700L
B	•	-	25	-	-	25	4	M8 x 1	5	1,5	DC8/4700
B	•	5	20	-	-	25	4	M8 x 1	3	2,5	DC8/5700
B	•	-	30	-	-	30	4	M12 x 1	5	2	DC12/4600
F	•	-	30	-	20	50	4	M12 x 1	5	2	DC12/4700
B	•	7	23	-	-	30	4	M12 x 1	1	4	DC12/5600
F	•	7	23	-	20	50	4	M12 x 1	1	4	DC12/5700

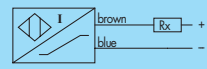

CYLINDRICAL INDUCTIVE SENSORS IN METAL HOUSING

- **NAMUR SERIES - diameters 14 - 16 - 18 mm**
- **Non amplified in d.c. 2 wires**
- **Cable output**

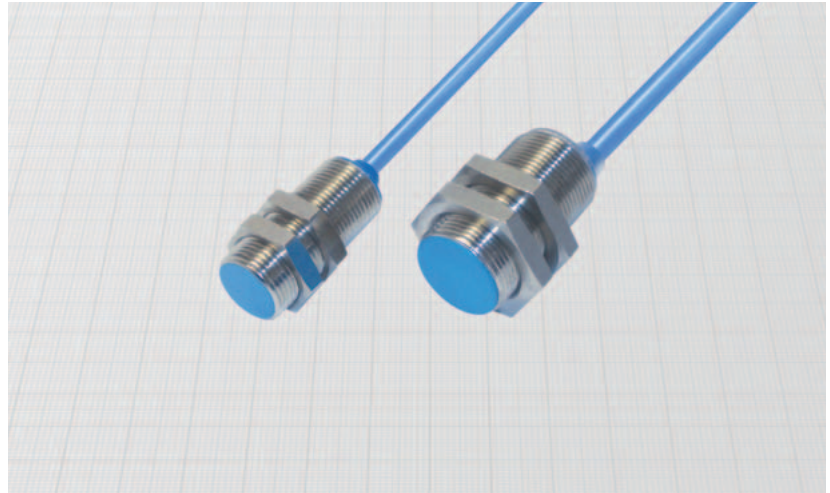
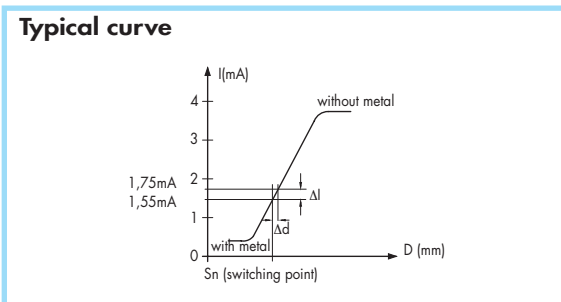
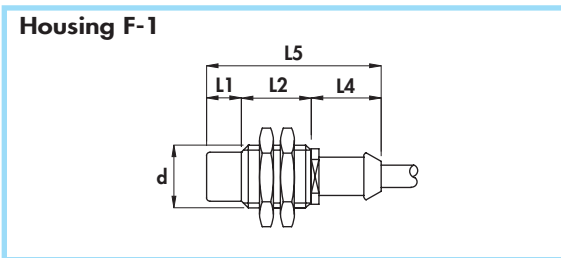
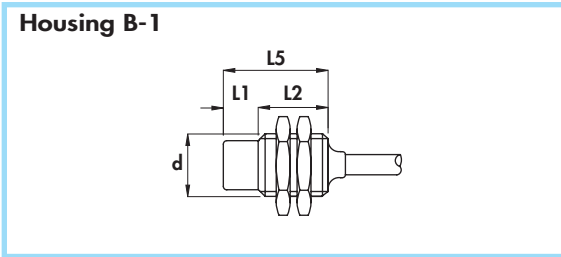

Diameter	M14 x 1	M16 x 1	M18 x 1
Nut	Size	SW17	SW22
	Thickness mm	4	4
Max tightening torque Nm	20	25	35

Materials:

- Cable: 2 m PVC CEI 20 - 22 II; 90°C; 300 V; O.R.
- Housing: nickel plated brass
- Sensing face: plastic

Technical data:

- Working voltage: 5 ÷ 30 Vdc
- Supply voltage according to NAMUR: 7,7 ÷ 9 Vdc
- Max ripple: 10%
- Consumption at 8,2 V with Rx = 1000 Ω
 - with metal: ≤ 1 mA
 - without metal: ≥ 3 mA
- Temperature range: - 25° ÷ + 70°C
- Max thermal drift of sensing distance S_p: ± 10%
- Repeat accuracy (R): 2%
- Degree of protection: IP67
- Cable conductor cross section: 0,35 mm² on 14 ÷ 16 mm, 0,50 mm² on 18 mm
- According to EN60947-5-6
- Electromagnetic compatibility (EMC) according to EN60947-5-2
- Shock and vibration resistance according to EN60068-2-27 EN60068-2-6
- For certified ATEX version see ATEX Catalogue

Housing	Flush mounting Non flush mounting	L1	L2	L3	L4	L5	Cable diameter	Body diameter (d)	Max switching frequency (f)	Nominal sensing distance (S _n) ± 10%	ORDERING REFERENCES
		mm	mm	mm	mm	mm					
B-1	•	-	30	-	-	30	4	M14 x 1	2	3	DC14/4700 DC14/5700
B-1	•	10	30	-	-	40	4	M14 x 1	1	5	
B-1	•	-	30	-	-	30	4	M16 x 1	2	4	DC16/4700 DC16/5700
B-1	•	10	30	-	-	40	4	M16 x 1	1	5,5	
B-1	•	-	30	-	-	30	6	M18 x 1	1	5	DC18/4600 DC18/4700
F-1	•	-	30	-	20	50	6	M18 x 1	1	5	
B-1	•	10	20	-	-	30	6	M18 x 1	0,5	8	DC18/5600 DC18/5700
F-1	•	10	20	-	20	50	6	M18 x 1	0,5	8	

ORDERING REFERENCES

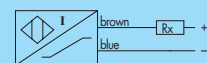

NAMUR SERIES - diameters 4 - 5 - 6,5 - 8 - 12 mm •
Non amplified in d.c. 2 wires •
Cable output •

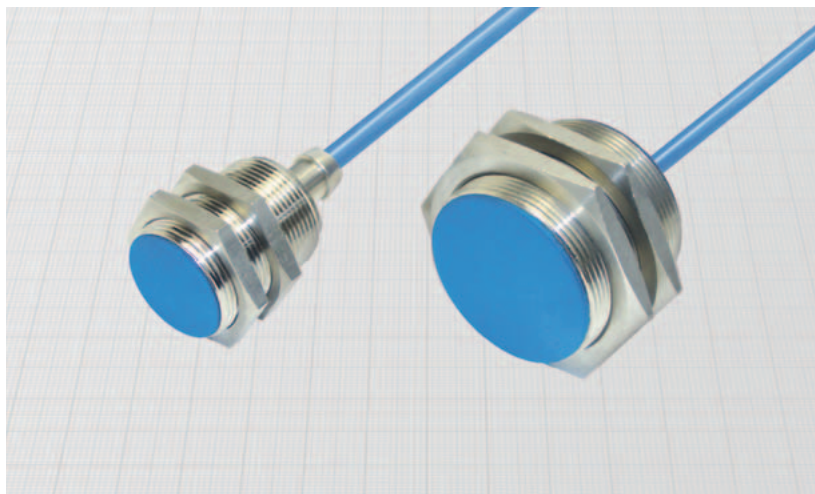
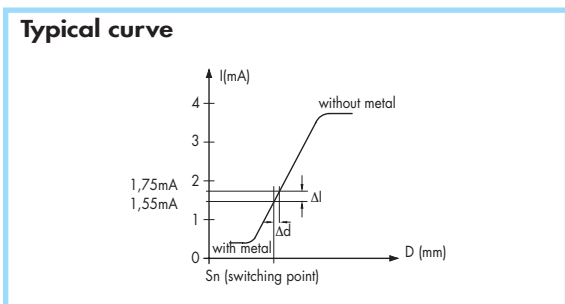
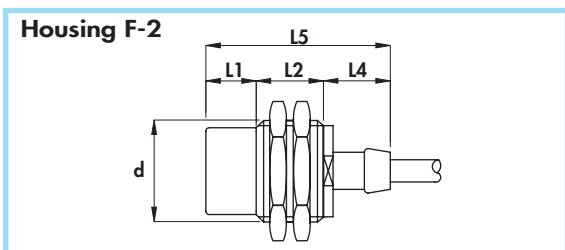
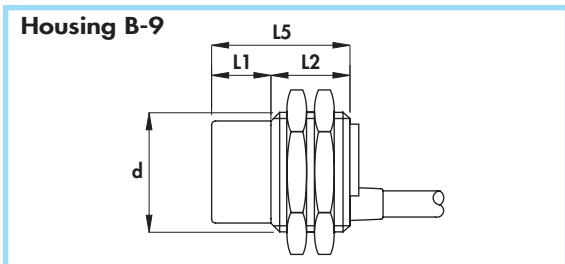

Diameter		M28 x 1,5	M30 x 1,5	M35 x 1,5	M45 x 1,5
Nut	Size	SW32	SW36	SW41	SW55
	Thickness mm	4	5	5	5
Max tightening torque Nm		80	80	70	70

Materials:

- Cable: 2 m PVC CEI 20 - 22 II; 90°C; 300 V; O.R.
- Housing: nickel plated brass
- Sensing face: plastic

Technical data:

- Working voltage: $5 \div 30$ Vdc
- Supply voltage according to NAMUR: $7,7 \div 9$ Vdc
- Max ripple: 10%
- Consumption at 8,2 V with $R_x = 1000 \Omega$
 - with metal: ≤ 1 mA
 - without metal: ≥ 3 mA
- Temperature range: $-25 \div +70^\circ\text{C}$
- Max thermal drift of sensing distance S_r : $\pm 10\%$
- Repeat accuracy (R): 2%
- Degree of protection: IP67
- Cable conductor cross section: $0,50 \text{ mm}^2$
- According to EN60947-5-6
- Electromagnetic compatibility (EMC) according to EN60947-5-2
- Shock and vibration resistance according to EN60068-2-27 EN60068-2-6
- For certified ATEX version see ATEX Catalogue

Housing	Flush mounting Non flush mounting	L1	L2	L3	L4	L5	Cable diameter	Body diameter (d)	Max switching frequency (f)	Nominal sensing distance (S _n) $\pm 10\%$	ORDERING REFERENCES
		mm	mm	mm	mm	mm					
B-9	•	-	35	-	-	35	6	M28 x 1,5	0,3	10	DC28/4700 DC28/5700
B-9	•	10	25	-	-	35	6	M28 x 1,5	0,2	15	
B-9	•	-	35	-	-	35	6	M30 x 1,5	0,3	10	DC30/4600 DC30/4700 DC30/5600 DC30/5700
F-2	•	-	35	-	20	55	6	M30 x 1,5	0,3	10	
B-9	•	15	20	-	-	35	6	M30 x 1,5	0,2	15	
F-2	•	15	20	-	20	55	6	M30 x 1,5	0,2	15	
B-9	•	-	35	-	-	35	6	M35 x 1,5	0,3	15	DC35/4700
B-9	•	-	35	-	-	35	6	M45 x 1,5	0,3	20	DC45/4700

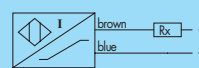

CYLINDRICAL INDUCTIVE SENSORS IN METAL HOUSING

- **NAMUR SERIES with LED**
- **Non amplified in d.c. 2 wires**
- **Cable output**

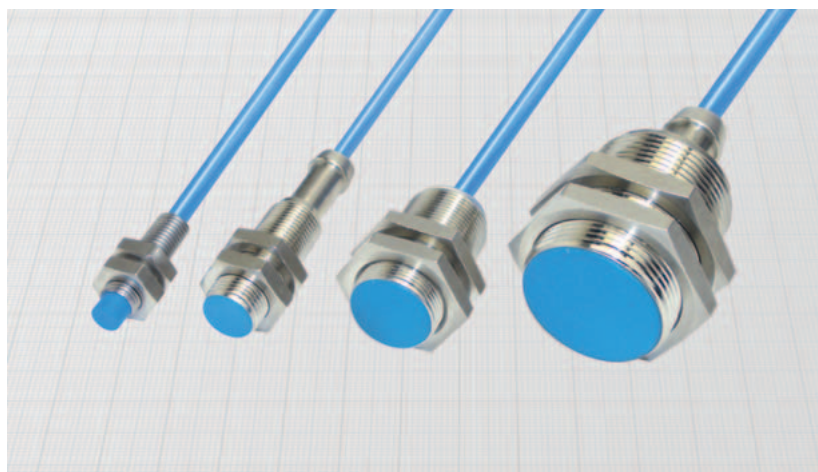
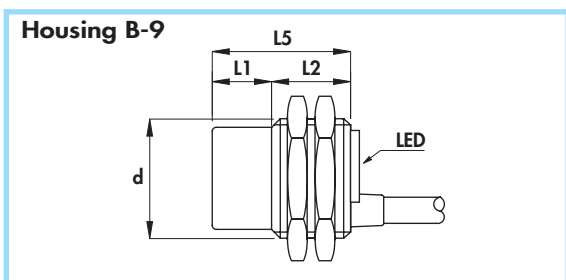
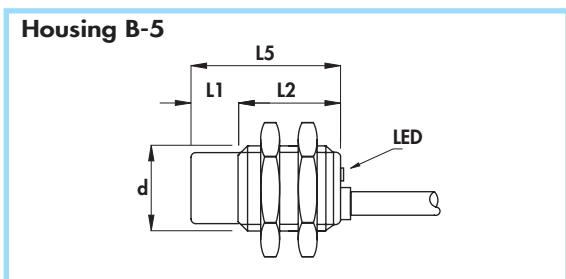
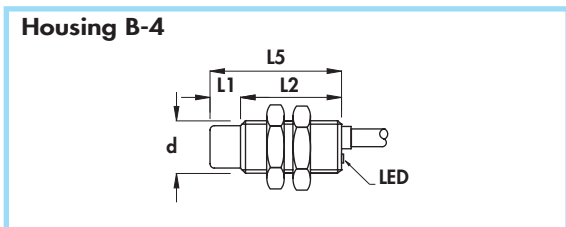
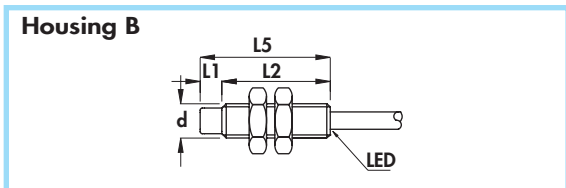

General Features:

With this new series of sensors it's possible to drive specific inputs for NAMUR sensors or inputs for 2 wires amplified switches with low current (up to 10 mA). The output is internally triggered and monitored by LED. The load can be applied on both terminals (function PNP or NPN).

Technical data:

- Working voltage: $7,7 \div 30$ Vdc
- Max ripple: 10%
- Off-state current (I_o): <1 mA
- Minimum operational current (I_m): 2 mA
- Rated operational current (I_r): 10 mA
- Voltage drop (U_d) with load 10 mA: < 6,5 V
- Voltage drop (U_d) with load 8 mA: < 5 V
- Temperature range: $-25^\circ \div +70^\circ\text{C}$
- Max thermal drift of sensing distance S_p : $\pm 10\%$
- Repeat accuracy (R): 2%
- Switching hysteresis (H): 10%
- Degree of protection: IP67
- Switch status indicator: yellow LED
- Cable conductor cross section: $0,35 \text{ mm}^2$ on 8 and 12 mm
 $0,75 \text{ mm}^2$ on 18 and 30 mm

- Protected against short-circuit and overload (8 mm not included)
- Protected against any wrong connection
- According to EN60947-5-6
- Electromagnetic compatibility (EMC) according to EN60947-5-2
- Shock and vibration resistance according to EN60068-2-27 EN60068-2-6
- For certified ATEX version see ATEX Catalogue

Diameter	M8 x 1	M12 x 1	M18 x 1	M30 x 1,5	
Nut	Size	SW13	SW17	SW24	SW36
	Thickness mm	4	4	4	5
Max tightening torque Nm	10	15	35	80	

Materials:

- Cable: 2 m PVC CEI 20 - 22 II; 90°C; 300 V; O.R.
- Housing 8 mm: stainless steel
- Housing 12 - 18 - 30 mm: nickel plated brass
- Sensing face: plastic

Use according to NAMUR:

- Supply voltage: $7,7 \div 9$ Vdc
- Consumption at 8,2 V with $R_x = 1000 \Omega$
 - with metal: ≤ 1 mA
 - without metal: ≥ 3 mA

Housing	Flush mounting Non flush mounting	L1	L2	L3	L4	L5	Cable diameter	Body diameter (d)	Max switching frequency (f)	Nominal sensing distance (S_n) $\pm 10\%$	ORDERING REFERENCES	
											mm	mm
B	•	-	30	-	-	30	4	M8 x 1	3	1,5	 DC8/4600S DC8/5600S	 DC8/4610S DC8/5610S
B	•	5	25	-	-	30	4	M8 x 1	2	2,5		
B-4	•	-	30	-	-	30	4	M12 x 1	2	2	DC12/4600KS DC12/5600KS	DC12/4610KS DC12/5610KS
B-4	•	7	23	-	-	30	4	M12 x 1	1	4		
B-5	•	-	30	-	-	30	5	M18 x 1	0,8	5	DC18/4600KS DC18/5600KS	DC18/4610KS DC18/5610KS
B-5	•	10	20	-	-	30	5	M18 x 1	0,6	8		
B-9	•	-	35	-	-	35	5	M30 x 1,5	0,8	10	DC30/4600KS DC30/5600KS	DC30/4610KS DC30/5610KS
B-9	•	15	20	-	-	35	5	M30 x 1,5	0,4	15		

NAMUR SERIES •
Non amplified in d.c. •
Connector output M8 x 1 •

Housing I-3

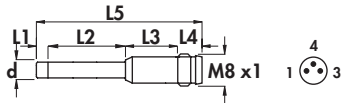

Housing I-4

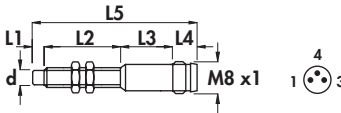

Housing I-8

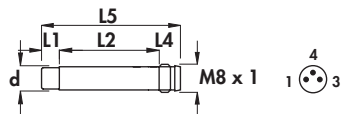

Housing I-6

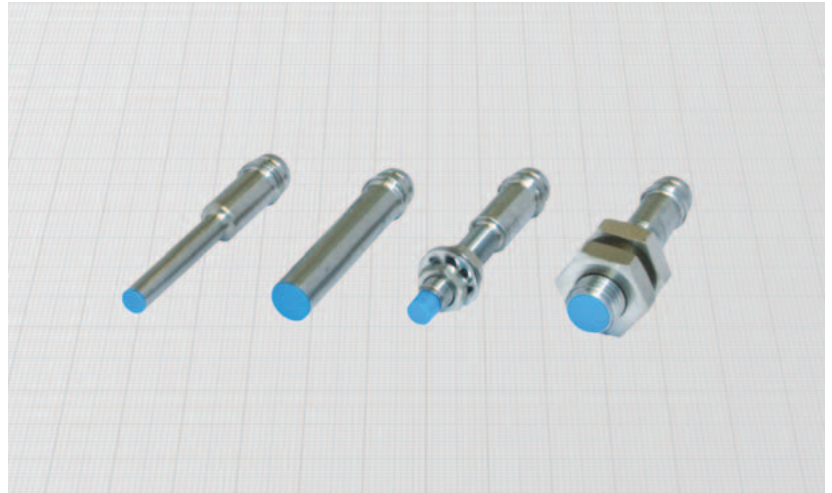
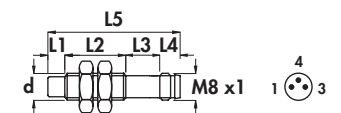

Typical curve

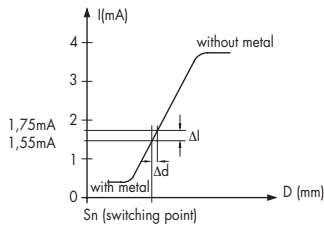

Diameter	M5 x 0,5	M8 x 1
Nut	Size	SW7
	Thickness mm	2,5
Max tightening torque Nm	2	10

Materials:

- Housing: stainless steel
- Sensing face: plastic

Technical data:

- Working voltage: 5 ÷ 30 Vdc
- Supply voltage according to NAMUR: 7,7 ÷ 9 Vdc
- Max ripple: 10%
- Consumption at 8,2 V with Rx = 1000 Ω
 - with metal: ≤ 1 mA
 - without metal: ≥ 3 mA
- Temperature range: - 25° ÷ + 70°C
- Max thermal drift of sensing distance S_n: ± 10%
- Repeat accuracy (R): 2%
- Degree of protection: IP67
- According to EN60947-5-6
- Electromagnetic compatibility (EMC) according to EN60947-5-2
- Shock and vibration resistance according to EN60068-2-27 EN60068-2-6

Housing	Flush mounting Non flush mounting	L1	L2	L3	L4	L5	Female connector	Body diameter (d)	Max switching frequency (f)	Nominal sensing distance (S _n) ± 10%	ORDERING REFERENCES
		mm	mm	mm	mm	mm					
I-3	•	-	22	12	5,5	39,5	11-12	4	5	0,8	DC4/4900L
I-4	•	-	22	12	5,5	39,5	11-12	M5 x 0,5	5	0,8	DC5/4900
I-8	•	-	29,5	-	5,5	35	11-12	6,5	4	1,5	DC6,5/4900L
I-8	•	5	24,5	-	5,5	35	11-12	6,5	3	2,5	DC6,5/5900L
I-6	•	-	21	8,5	5,5	35	11-12	M8 x 1	4	1,5	DC8/4900
I-6	•	5	16	8,5	5,5	35	11-12	M8 x 1	3	2,5	DC8/5900

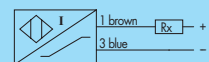

CYLINDRICAL INDUCTIVE SENSORS IN METAL HOUSING

- **NAMUR SERIES**
- **Non amplified in d.c.**
- Connector output M12 x 1

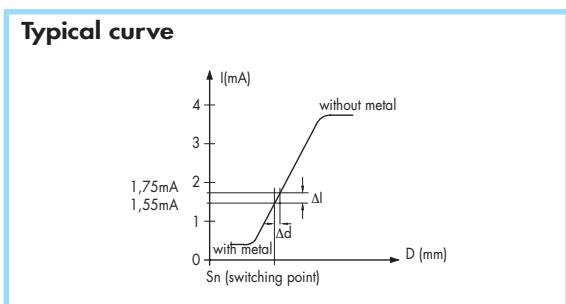
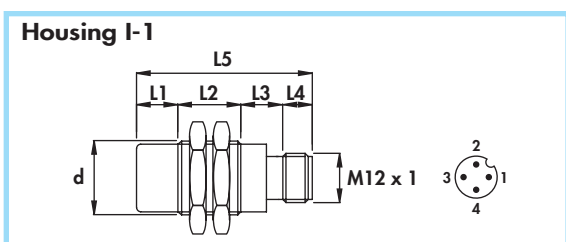
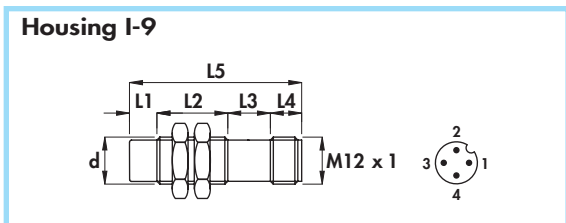
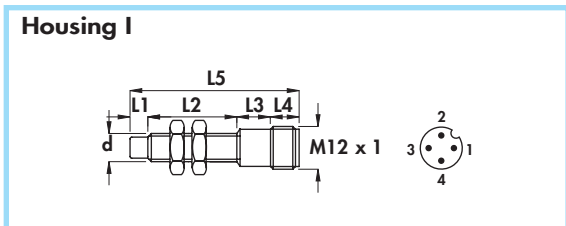

Diameter		M8 x 1	M12 x 1	M18 x 1	M30 x 1,5
Nut	Size	SW13	SW17	SW24	SW36
	Thickness mm	4	4	4	5
Max tightening torque Nm		10	15	35	80

Materials:

- Housing 8 mm: stainless steel
- Housing 12 - 18 - 30 mm: nickel plated brass
- Sensing face: plastic

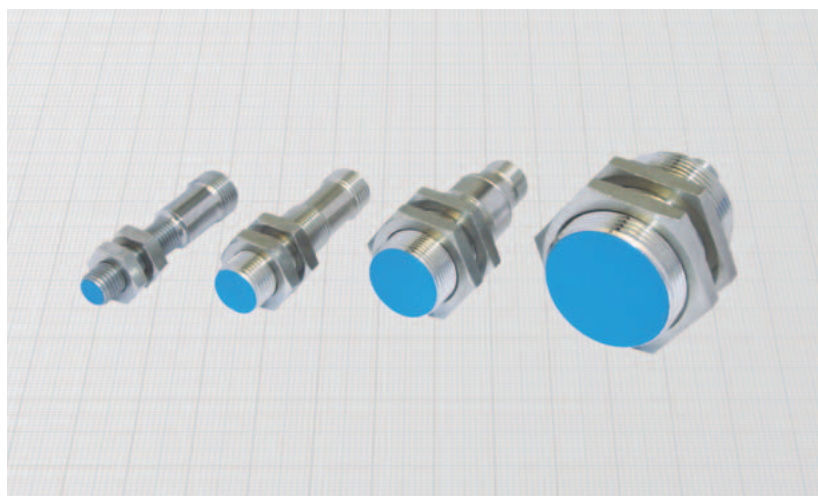

Technical data:

- Working voltage: 5 ÷ 30 Vdc
- Supply voltage according to NAMUR: 7,7 ÷ 9 Vdc
- Max ripple: 10%
- Consumption at 8,2 V with Rx = 1000 Ω
 - with metal: ≤ 1 mA
 - without metal: ≥ 3 mA
- Temperature range: - 25° ÷ + 70°C
- Max thermal drift of sensing distance S_r: ± 10%
- Repeat accuracy (R): 2%
- Degree of protection: IP67
- According to EN60947-5-6
- Electromagnetic compatibility (EMC) according to EN60947-5-2
- Shock and vibration resistance according to EN60068-2-27 EN60068-2-6
- For certified ATEX version see ATEX Catalogue

Housing	Flush mounting Non flush mounting	L1	L2	L3	L4	L5	Female connector	Body diameter (d)	Max switching frequency (f)	Nominal sensing distance (S _n) ± 10%	ORDERING REFERENCES
		mm	mm	mm	mm	mm					
I	•	-	26	13	8	47	6-8B-10	M8 x 1	4	1,5	DC8/4300 DC8/5300
	•	5	21	13	8	47	6-8B-10	M8 x 1	3	2,5	
I-9	•	-	30	10	8	48	6-8B-10	M12 x 1	2	2	DC12/4300 DC12/5300
	•	7	23	10	8	48	6-8B-10	M12 x 1	1	4	
I-1	•	-	25	15	8	48	6-8B-10	M18 x 1	0,8	5	DC18/4300 DC18/5300
	•	10	15	15	8	48	6-8B-10	M18 x 1	0,6	8	
I-1	•	-	25	17	8	50	6-8B-10	M30 x 1,5	0,8	10	DC30/4300 DC30/5300
	•	15	25	17	8	65	6-8B-10	M30 x 1,5	0,4	15	

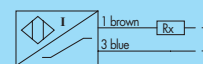

NAMUR SERIES with LED •
Non amplified in d.c. •
Connector output M12 x 1 •

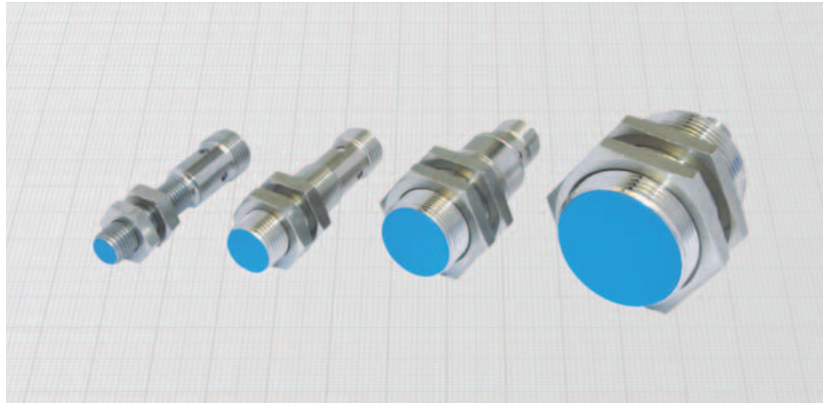
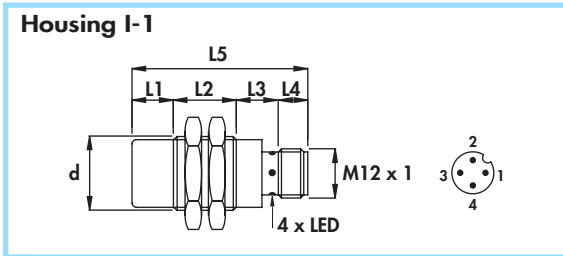
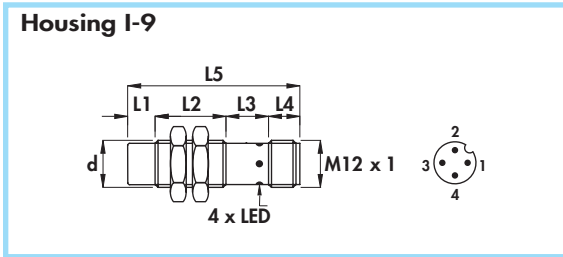
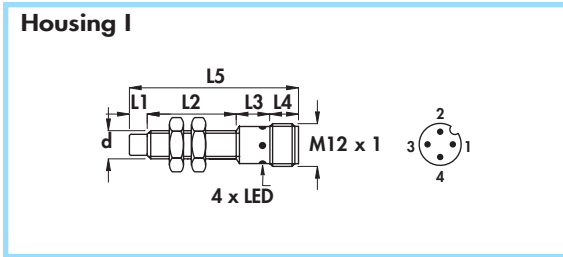

General Features:

With this new series of sensors it's possible to drive specific inputs for NAMUR sensors or inputs for 2 wires amplified switches with low current (up to 10 mA). The load can be applied on both terminals (function PNP or NPN). Thanks to LED monitoring and to the internally triggered output, direct use is allowed with PLC and other electronic inputs optimizing in this way the wiring and the reliability of the entire system.

Technical data:

- Working voltage: 7,7 ÷ 30 Vdc
- Max ripple: 10%
- Off-state current (I_o): < 1 mA
- Minimum operational current (I_m): 2 mA
- Rated operational current (I_e): 10 mA
- Voltage drop (U_d) with load 10 mA: < 6,5 V
- Voltage drop (U_d) with load 8 mA: < 5 V
- Temperature range: - 25° ÷ +70°C
- Max thermal drift of sensing distance S_r: ± 10%
- Repeat accuracy (R): 2%
- Switching hysteresis (H): 10%
- Degree of protection: IP67
- Switch status indicator: yellow LED
- Protected against short-circuit and overload (8 mm not included)
- Protected against any wrong connection
- According to EN60947-5-6
- Electromagnetic compatibility (EMC) according to EN60947-5-2
- Shock and vibration resistance according to EN60068-2-27 EN60068-2-6

Diameter	M8 x 1	M12 x 1	M18 x 1	M30 x 1,5	
Nut	Size	SW13	SW17	SW24	SW36
	Thickness mm	4	4	4	5
Max tightening torque Nm	10	15	35	80	

Materials:

- Housing 8 mm: stainless steel
- Housing 12 - 18 - 30 mm: nickel plated brass
- Sensing face: plastic

Use according to NAMUR:

- Supply voltage: 7,7 ÷ 9 Vdc
- Consumption at 8,2 V with R_x = 1000 Ω
 with metal: ≤ 1 mA
 without metal: ≥ 3 mA
- For certified ATEX version see ATEX Catalogue

Housing	Flush mounting Non flush mounting	L1	L2	L3	L4	L5	Female connector	Body diameter (d)	Max switching frequency (f)	Nominal sensing distance (S _r) ± 10%	ORDERING REFERENCES		
											mm	mm	mm
I	•	-	26	13	8	47	6-8B-10	M8 x 1	3	1,5		DC8/4300S	DC8/4310S
	•	5	21	13	8	47	6-8B-10	M8 x 1	2	2,5		DC8/5300S	DC8/5310S
I-9	•	-	30	10	8	48	6-8B-10	M12 x 1	2	2		DC12/4300KS	DC12/4310KS
	•	7	23	10	8	48	6-8B-10	M12 x 1	1	4		DC12/5300KS	DC12/5310KS
I-1	•	-	25	16	8	49	6-8B-10	M18 x 1	0,8	5		DC18/4300KS	DC18/4310KS
	•	10	15	16	8	49	6-8B-10	M18 x 1	0,6	8		DC18/5300KS	DC18/5310KS
I-1	•	-	25	17	8	50	6-8B-10	M30 x 1,5	0,8	10		DC30/4300KS	DC30/4310KS
	•	15	25	17	8	65	6-8B-10	M30 x 1,5	0,4	15		DC30/5300KS	DC30/5310KS

CYLINDRICAL INDUCTIVE SENSORS IN METAL HOUSING

- **NAMUR SERIES** - for high temperatures (-25° ÷ +110°C)
- **Non amplified in d.c. 2 wires**
- Cable output

Housing A

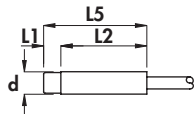

Housing B

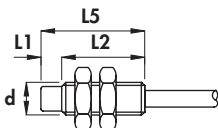

Housing B-1

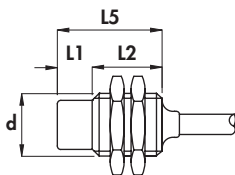

Typical curve

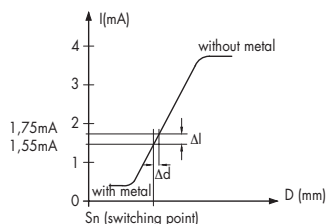

Diameter		M8 x 1	M12 x 1	M18 x 1	M30 x 1,5	M45 x 1,5
Nut	Size	SW13	SW17	SW24	SW36	SW55
	Thickness mm	4	4	4	5	5
Max tightening torque Nm		10	15	35	80	70

Materials:

- Cable: 2 m thermoplastic 140°C; 300 V; O.R.
- Housing 6,5 - 8 mm: stainless steel
- Housing 12 ÷ 45 mm: nickel plated brass
- Sensing face: plastic

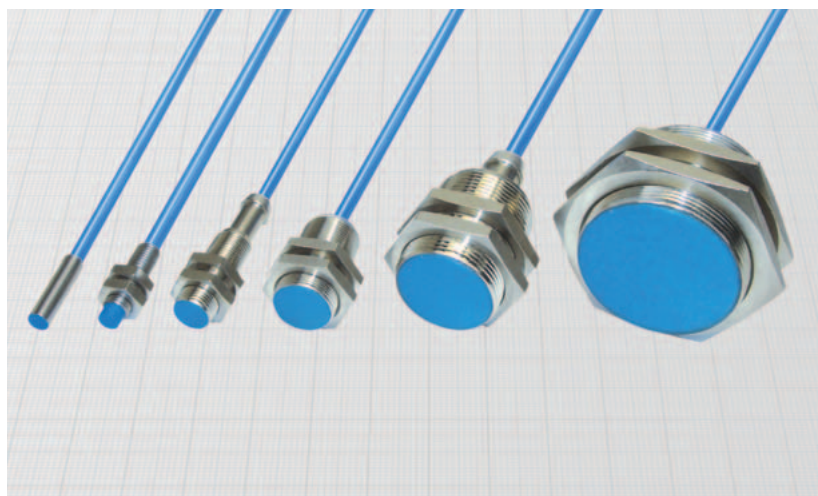

Technical data:

- Working voltage: 5 ÷ 30 Vdc
- Supply voltage according to NAMUR: 7,7 ÷ 9 Vdc
- Max ripple: 10%
- Consumption at 8,2 V with Rx = 1000 Ω
 - with metal: ≤ 1 mA
 - without metal: ≥ 3 mA
- Temperature range: -25° ÷ +110°C
- Max thermal drift of sensing distance S_n: ± 10%
- Repeat accuracy (R): 2%
- Degree of protection: IP67
- Cable conductor cross section: 0,35 mm² on 6,5 ÷ 12 mm; 0,50 mm² on 18 ÷ 45 mm
- According to EN60947-5-6
- Electromagnetic compatibility (EMC) according to EN60947-5-2
- Shock and vibration resistance according to EN60068-2-27 EN60068-2-6
- For certified ATEX version see ATEX Catalogue

Housing	Mounting	L1	L2	L3	L4	L5	Cable diameter	Body diameter (d)	Max switching frequency (f)	Nominal sensing distance (S _n) ± 10%	ORDERING REFERENCES
		mm	mm	mm	mm	mm					
A	•	-	25	-	-	25	4	6,5	5	1,5	DC6,5/4600LT
B	•	-	25	-	-	25	4	M8 x 1	5	1,5	DC8/4600T
B	•	-	30	-	-	30	4	M12 x 1	5	2	DC12/4600T
B-1	•	-	30	-	-	30	5	M18 x 1	1	5	DC18/4600T
B-1	•	-	35	-	-	35	6	M30 x 1,5	0,3	10	DC30/4600T
B-1	•	-	35	-	-	35	6	M45 x 1,5	0,3	20	DC45/4600T

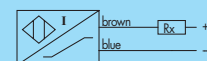

Diameters 4 - 5 mm •
 Amplified in d.c. 3 wires •
 Cable output •

Housing A-3

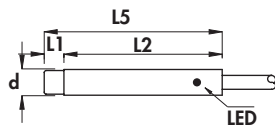

Housing B-6

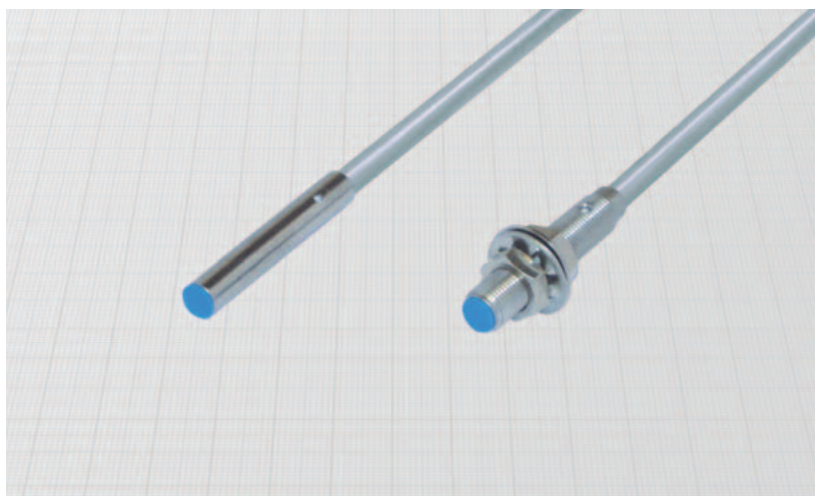
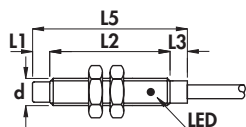

Diameter	M5 x 0,5	
Nut	Size	SW7
	Thickness mm	2,5
Max tightening torque Nm	2	

Materials:

- Cable: 2 m PVC CEI 20 - 22 II; 90°C; 300 V; O.R.
- Housing: stainless steel
- Sensing face: plastic

Technical data:

- Supply voltage (U_B): 7 ÷ 30 Vdc
- Max ripple: 10%
- No-load supply current (I_0): ≤ 10 mA
- Voltage drop (U_d): ≤ 1,5 V
- Temperature range: -25° ÷ +70°C
- Max thermal drift of sensing distance S_r : ± 10%
- Repeat accuracy (R): 2%
- Switching hysteresis (H): 10%
- Degree of protection: IP67
- Switch status indicator: yellow LED
- Cable conductor cross section: 0,15 mm²
- Protected against short-circuit and overload (versions with letter K)
- Protected against any wrong connection
- Suppression of initial false impulse
- Electromagnetic compatibility (EMC) according to EN60947-5-2
- Shock and vibration resistance according to EN60068-2-27 EN60068-2-6

Housing	Flush mounting Non flush mounting	L1	L2	L3	L5	Cable diameter	Body diameter (d)	Max switching frequency (f)	Rated operational current (I_e)	Nominal sensing distance (S_n) ± 10%	ORDERING REFERENCES	
											PNP (positive switching)	
A - 3	•	-	25	-	25	3	4	5	200	0,8		
A - 3	•	3	22	-	25	3	4	5	200	1,4		
A - 3	•	-	30	-	30	3	4	5	200	1		
A - 3	•	3	27	-	30	3	4	5	200	1,4		
B - 6	•	-	20	5	25	3	M5 x 0,5	5	200	0,8		
B - 6	•	3	17	5	25	3	M5 x 0,5	5	200	1,4		
B - 6	•	-	25	5	30	3	M5 x 0,5	5	200	1		
B - 6	•	3	22	5	30	3	M5 x 0,5	5	200	1,4		
NPN (negative switching)												
Use the above mentioned part number changing the last number 9 with 8 (ie. DCA4/4608LS)												

CYLINDRICAL INDUCTIVE SENSORS IN METAL HOUSING

- Diameters 6,5 - 8 mm
- Amplified in d.c. 3 and 4 wires
- Cable output

Housing A-3

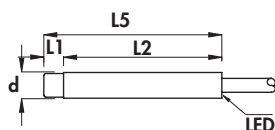

Housing B-6

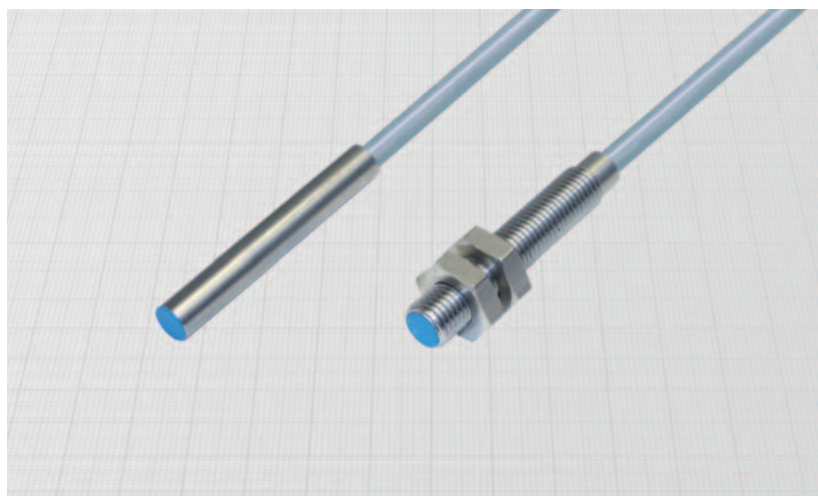
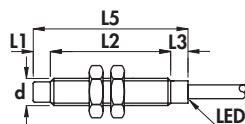

Diameter	M8 x 1	
Nut	Size	SW13
	Thickness mm	4
Max tightening torque Nm	10	

Materials:

- Cable: 2 m PVC CEI 20 - 22 II; 90°C; 300 V; O.R.
- Housing: stainless steel
- Sensing face: plastic

Technical data:

- Supply voltage (U_B): 7 ÷ 30 Vdc
 - Max ripple: 10%
 - No-load supply current (I_0): ≤ 10 mA
 - Voltage drop (U_d): ≤ 1,5 V
 - Temperature range: - 25° ÷ + 70°C
 - Max thermal drift of sensing distance S_s : ± 10%
 - Repeat accuracy (R): 2%
 - Switching hysteresis (H): 10%
 - Degree of protection: IP67
 - Switch status indicator: yellow LED
 - Cable conductor cross section: 0,15 mm² on 4 wires versions
0,22 mm² on 3 wires versions
- Protected against short-circuit and overload
 - Protected against any wrong connection
 - Suppression of initial false impulse
 - Electromagnetic compatibility (EMC) according to EN60947-5-2
 - Shock and vibration resistance according to EN60068-2-27 EN60068-2-6

Housing	Flush mounting Non flush mounting	L1	L2	L3	L5	Cable diameter	Body diameter (d)	Max switching frequency (f)	No-load supply current (I_0)	Nominal sensing distance (S_n) ±10%	ORDERING REFERENCES		
											mm	mm	mm
A - 3	•	-	45	-	45	3,5	6,5	4	200	1,5			
A - 3	•	5	40	-	45	3,5	6,5	3	200	2,5	DCA6,5/4609LKS DCA6,5/5609LKS	DCA6,5/4619LKS DCA6,5/5619LKS	DCA6,5/4629LKS DCA6,5/5629LKS
A - 3	•	-	45	-	45	3,5	8	4	200	1,5			
B - 6	•	-	40	5	45	3,5	M8 x 1	4	200	1,5	DCA8/4609LKS DCA8/4609KS	DCA8/4619LKS DCA8/4619KS	DCA8/4629LKS DCA8/4629KS
A - 3	•	5	40	-	45	3,5	8	3	200	2,5	DCA8/5609LKS DCA8/5609KS	DCA8/5619LKS DCA8/5619KS	DCA8/5629LKS DCA8/5629KS
B - 6	•	5	35	5	45	3,5	M8 x 1	3	200	2,5	DCA8/5609LKS DCA8/5609KS	DCA8/5619LKS DCA8/5619KS	DCA8/5629LKS DCA8/5629KS

NPN (negative switching)

Use the above mentioned part number changing the last number 9 with 8 (ie. DCA6,5/4608LKS)

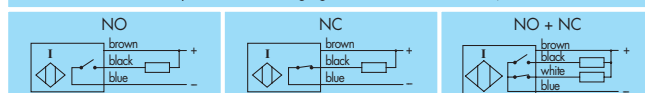

Diameters 12 mm •
 Amplified in d.c. 3 and 4 wires •
 Cable output •

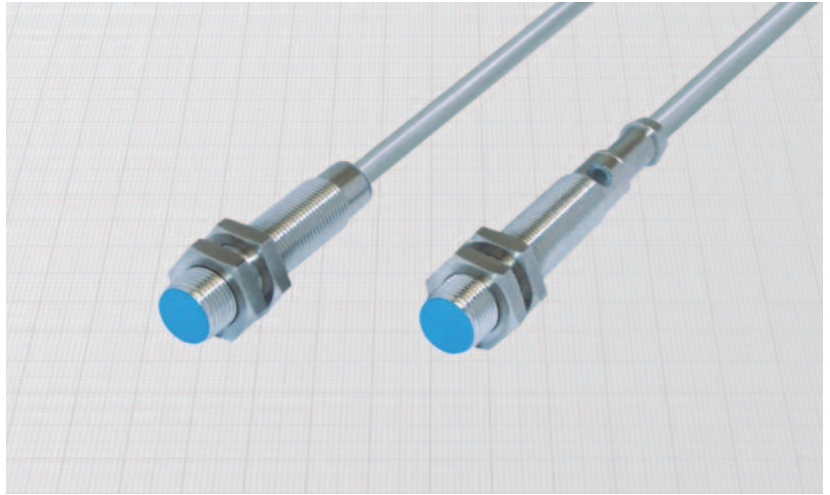
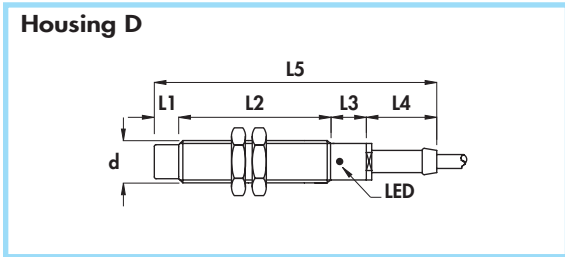
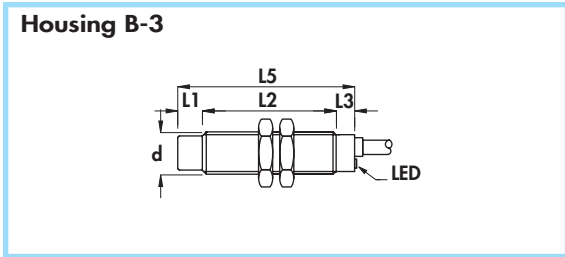

Diameter		M12 x 1	M14 x 1	M16 x 1
Nut	Size	SW17	SW17	SW22
	Thickness mm	4	4	4
Max tightening torque Nm		15	20	25

Materials:

- Cable: 2 m PVC CEI 20 - 22 II; 90°C; 300 V; O.R.
- Housing: nickel plated brass
- Sensing face: plastic

Technical data:

- Supply voltage (U_B): 5 ÷ 40 Vdc
 - Max ripple: 10%
 - No-load supply current (I_0): ≤ 10 mA
 - Voltage drop (U_d): ≤ 1,5 V
 - Temperature range: -25° ÷ +75°C
 - Max thermal drift of sensing distance S_r : ± 10%
 - Repeat accuracy (R): 2%
 - Switching hysteresis (H): 10%
 - Degree of protection: IP67
 - Switch status indicator: yellow LED
 - Cable conductor cross section: 0,35 mm² on 3 wires
0,25 mm² on 4 wires
- Protected against short-circuit and overload
 - Protected against any wrong connection
 - Suppression of initial false impulse
 - Electromagnetic compatibility (EMC) according to EN60947-5-2
 - Shock and vibration resistance according to EN60068-2-27 EN60068-2-6

Housing	Flush mounting Non flush mounting	L1	L2	L3	L4	L5	Cable diameter	Body diameter (d)	Max switching frequency (f)	Rated operational current (I _e)	Nominal sensing distance (S _n) ± 10%	ORDERING REFERENCES					
												PNP (positive switching)					
B-3	•	-	43	7	-	50	4	M12 x 1	2	200	2	NO brown black blue	NC brown black blue	NO + NC brown black white blue	DCA12/4609KS	DCA12/4619KS	DCA12/4629KS
D	•	-	50	10	20	80	4	M12 x 1	2	200	2				DCA12/4709KS	DCA12/4719KS	DCA12/4729KS
B-3	•	7	36	7	-	50	4	M12 x 1	1,5	200	4				DCA12/5609KS	DCA12/5619KS	DCA12/5629KS
D	•	7	43	10	20	80	4	M12 x 1	1,5	200	4				DCA12/5709KS	DCA12/5719KS	DCA12/5729KS

NPN (negative switching)

Use the above mentioned part number changing the last number 9 with 8 (ie DCA12/4608KS)

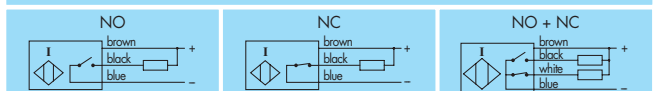

CYLINDRICAL INDUCTIVE SENSORS IN METAL HOUSING

- Diameters 18 mm
- Amplified in d.c. 3 and 4 wires
- Cable output

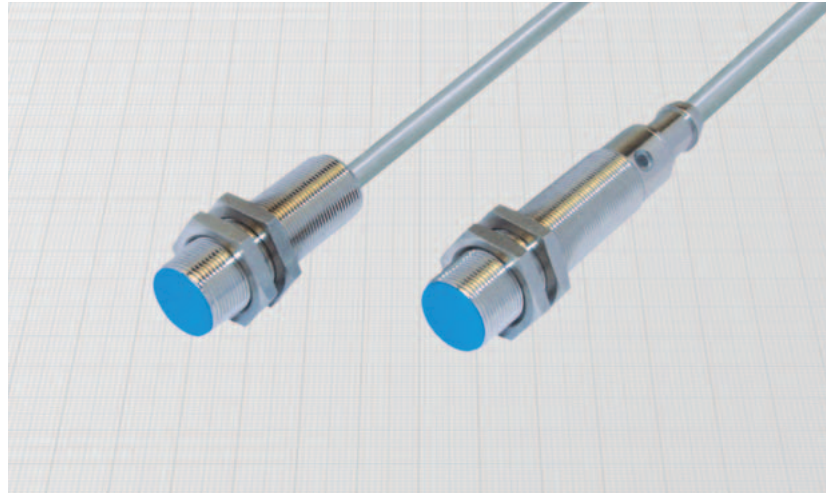
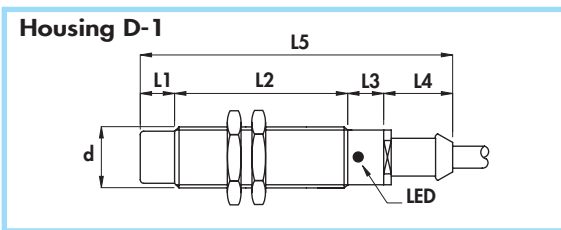
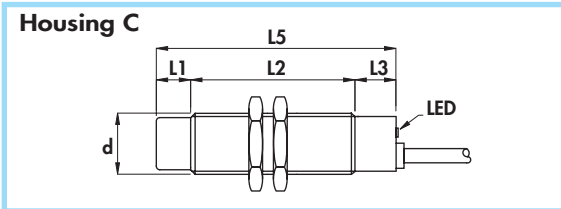
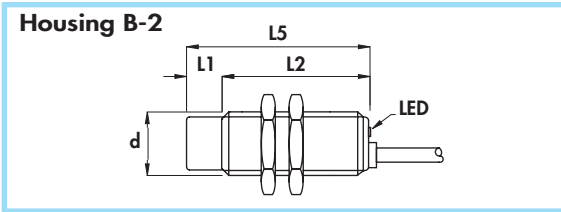

Diameter	M18 x 1	
Nut	Size	SW24
	Thickness mm	4
Max tightening torque Nm	35	

Materials:

- Cable: 2 m PVC CEI 20 - 22 II; 90°C; 300 V; O.R.
- Housing: nickel plated brass
- Sensing face: plastic

Technical data:

- Supply voltage (U_B): 5 ÷ 60 V
- Max ripple: 10%
- No-load supply current (I_0): ≤ 10 mA
- Voltage drop (U_d): ≤ 2,2 V
- Temperature range: - 25° ÷ + 75°C
- Max thermal drift of sensing distance S_s : ± 10%
- Repeat accuracy (R): 2%
- Switching hysteresis (H): 10%
- Degree of protection: IP67
- Switch status indicator: yellow LED
- Cable conductor cross section: 0,50 mm²
- Protected against short-circuit and overload
- Protected against any wrong connection
- Suppression of initial false impulse
- Electromagnetic compatibility (EMC) according to EN60947-5-2
- Shock and vibration resistance according to EN60068-2-27 EN60068-2-6

Housing	Flush mounting Non flush mounting	L1	L2	L3	L4	L5	Cable diameter	Body diameter (d)	Max switching frequency (f)	No-load supply current (I ₀)	Nominal sensing distance (S _n) ± 10%	ORDERING REFERENCES		
												PNP (positive switching)		
												NO	NC	NO + NC
												DCA18/4A09KS	DCA18/4A19KS	DCA18/4A29KS
												DCA18/5A09KS	DCA18/5A19KS	DCA18/5A29KS
												DCA18/4609KS	DCA18/4619KS	DCA18/4629KS
												DCA18/4709KS	DCA18/4719KS	DCA18/4729KS
												DCA18/5609KS	DCA18/5619KS	DCA18/5629KS
												DCA18/5709KS	DCA18/5719KS	DCA18/5729KS
												NPN (negative switching)		
												Use the above mentioned part number changing the last number 9 with 8 (ie DCA18/4A08KS)		
												NO	NC	NO + NC

Diameters 30 - 45 mm •
 Amplified in d.c. 3 and 4 wires •
 Cable output •

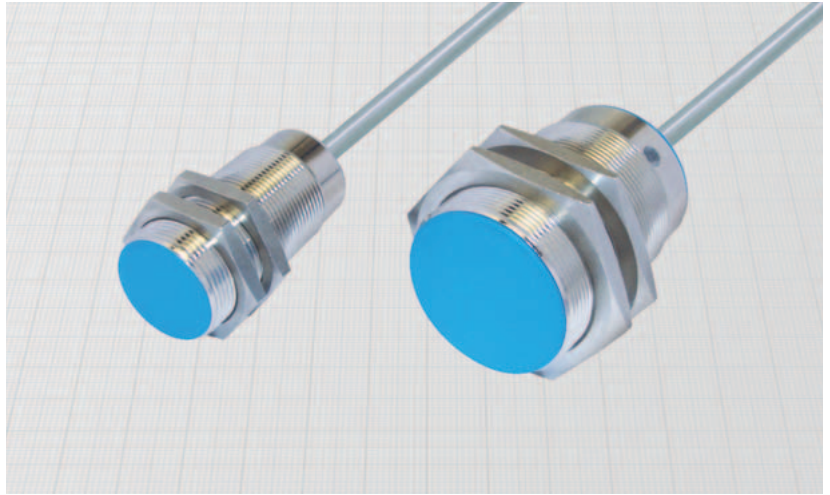
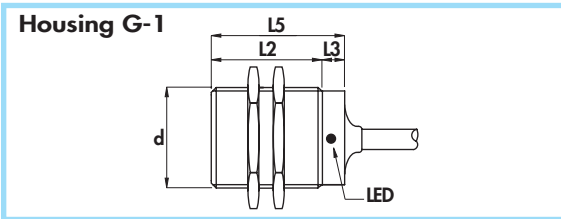
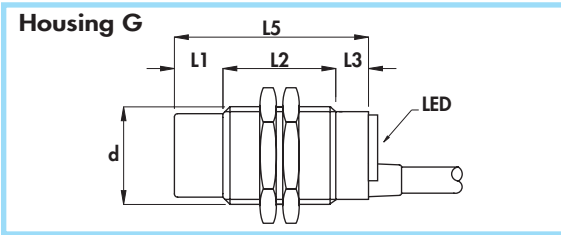
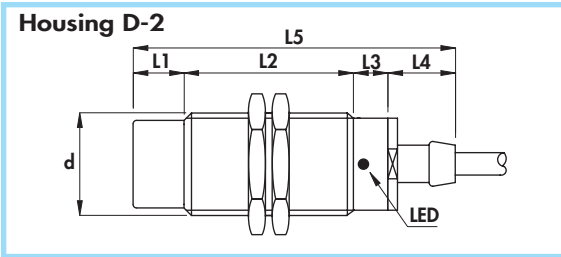

Diameter	M30 x 1,5	M45 x 1,5
Nut	Size	SW36
	Thickness mm	5
Max tightening torque Nm	80	70

Materials:

- Cable: 2 m PVC CEI 20 - 22 II; 90°C; 300 V; O.R.
- Housing: nickel plated brass
- Sensing face: plastic

Technical data:

- Supply voltage (U_B): 7 ÷ 60 Vdc
- Max ripple: 10%
- No-load supply current (I_0): ≤ 10 mA
- Voltage drop (U_d): ≤ 2,2 V
- Temperature range: -25° ÷ +75°C
- Max thermal drift of sensing distance S_T : ± 10%
- Repeat accuracy (R): 2%
- Switching hysteresis (H): 10%
- Degree of protection: IP67
- Switch status indicator: yellow LED
- Cable conductor cross section: 0,50 mm²
- Protected against short-circuit and overload
- Protected against any wrong connection
- Suppression of initial false impulse
- Electromagnetic compatibility (EMC) according to EN60947-5-2
- Shock and vibration resistance according to EN60068-2-27 EN60068-2-6

Housing	Flush mounting Non flush mounting	L1	L2	L3	L4	L5	Cable diameter	Body diameter (d)	Max switching frequency (f)	No-load supply current (I ₀)	Nominal sensing distance (S _n) ± 10%	ORDERING REFERENCES		
												mm	mm	mm
D-2	•	-	50	10	-	60	6	M30 x 1,5	0,8	400	10			
	•	-	65	10	20	95	6	M30 x 1,5	0,8	400	10			
D-2	•	15	35	10	-	60	6	M30 x 1,5	0,4	400	15			
	•	15	50	10	20	95	6	M30 x 1,5	0,4	400	15			
G-1	•	-	50	10	-	60	6	M45 x 1,5	0,15	400	20			

NPN (negative switching)

Use the above mentioned part number changing the last number 9 with 8 (ie DCA30/4608KS)

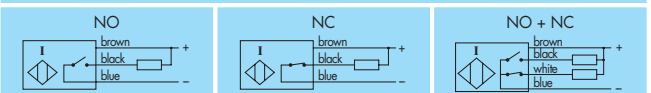

CYLINDRICAL INDUCTIVE SENSORS IN METAL HOUSING

- Diameters 4 - 5 - 6,5 - 8 mm
- Amplified in c.c.
- Connector output M8 x 1

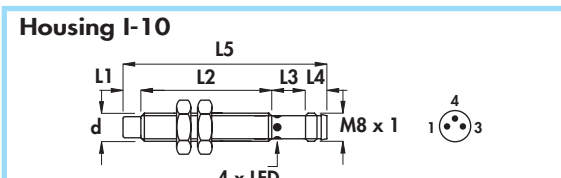
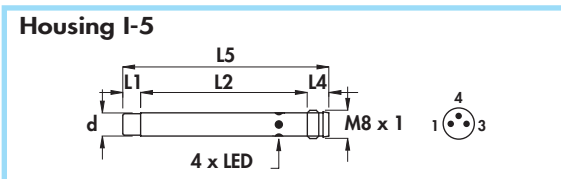
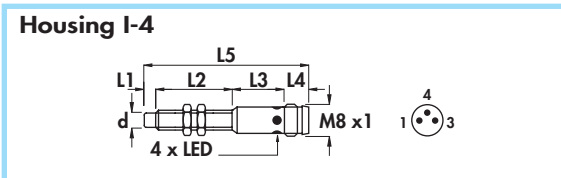
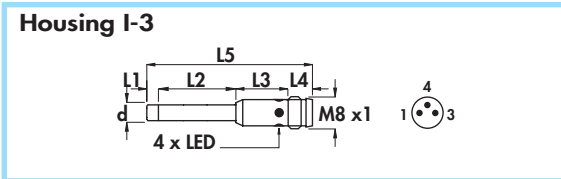

Diameter	M5x0,5	M8 x 1
Nut	Size	SW7
	Thickness mm	2,5
Max tightening torque Nm	2	10

Materials:

- Housing: stainless steel
- Sensing face: plastic

Technical data:

- Supply voltage (U_B): 7 ÷ 30 Vdc
- Max ripple: 10%
- No-load supply current (I_0): ≤ 10 mA
- Voltage drop (U_d): ≤ 1,5 V
- Temperature range: -25° ÷ +70°C
- Max thermal drift of sensing distance S_s : ± 10%
- Repeat accuracy (R): 2%
- Switching hysteresis (H): 10%
- Degree of protection: IP67
- Switch status indicator: yellow LED
- Protected against short-circuit and overload
- Protected against any wrong connection
- Suppression of initial false impulse
- Electromagnetic compatibility (EMC) according to EN60947-5-2
- Shock and vibration resistance according to EN60068-2-27 EN60068-2-6

Housing	Flush mounting Non flush mounting	L1	L2	L3	L4	L5	Female connector	Body diameter (d)	Max switching frequency (f)	Rated operational current (I _o)	Nominal sensing distance (S _s) ± 10%	ORDERING REFERENCES	
												PNP (positive switching)	
		mm	mm	mm	mm	mm	n°	mm	KHz	mA	mm		
I-3	•	-	22	12	5,5	39,5	11-12	4	5	200	1	DCA4/4909LKS	DCA4/4919LKS
I-3	•	3	19	12	5,5	39,5	11-12	4	5	200	1,4	DCA4/5909LKS	DCA4/5919LKS
I-4	•	-	22	12	5,5	39,5	11-12	M5 x 0,5	5	200	1	DCA5/4909KS	DCA5/4919KS
I-4	•	3	19	12	5,5	39,5	11-12	M5 x 0,5	5	200	1,4	DCA5/5909KS	DCA5/5919KS
I-5	•	-	48,5	-	5,5	54	11-12	6,5	4	200	1,5	DCA6,5/4909LKS	DCA6,5/4919LKS
I-5	•	5	43,5	-	5,5	54	11-12	6,5	3	200	2,5	DCA6,5/5909LKS	DCA6,5/5919LKS
I-10	•	-	40	8,5	5,5	54	11-12	M8 x 1	4	200	1,5	DCA8/4909KS	DCA8/4919KS
I-10	•	5	35	8,5	5,5	54	11-12	M8 x 1	3	200	2,5	DCA8/5909KS	DCA8/5919KS
												NPN (negative switching)	
Use the above mentioned part number changing the last number 9 with 8 (ie. DCA4/4908LKS)													

Diameters 8 - 12 mm •
Amplified in d.c. •
Connector output M12 x 1 •

Housing I-11

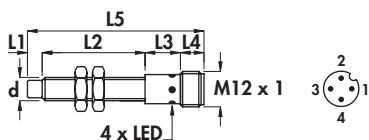

Housing I-7

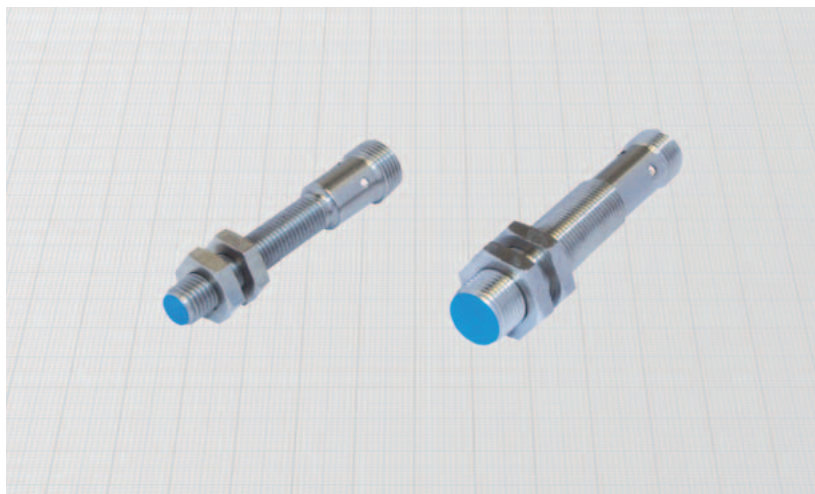
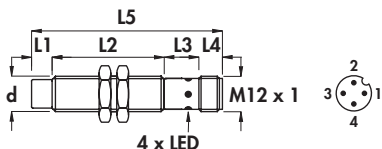

Diameter		M8 x 1	M12 x 1
Nut	Size	SW13	SW17
	Thickness mm	4	4
Max tightening torque Nm		10	15

Materials:

- Housing diametro 8 mm: stainless steel
- Housing diametro 12 mm: nickel plated brass
- Sensing face: plastic

Technical data:

- Supply voltage (U_B): diameter 8 mm 7 ÷ 30 Vdc
diameter 12 mm 5 ÷ 40 Vdc
- Max ripple: 10%
- No-load supply current (I_o): ≤ 10 mA
- Voltage drop (U_j): ≤ 1,5 V
- Temperature range: -25° ÷ +75°C
- Max thermal drift of sensing distance S_s : ± 10%
- Repeat accuracy (R): 2%
- Switching hysteresis (H): 10%
- Degree of protection: IP67
- Switch status indicator: yellow LED
- Protected against short-circuit and overload
- Protected against any wrong connection
- Suppression of initial false impulse
- Electromagnetic compatibility (EMC) according to EN60947-5-2
- Shock and vibration resistance according to EN60068-2-27 EN60068-2-6

Housing	Mounting	L1	L2	L3	L4	L5	Female connector	Body diameter (d)	Max switching frequency (f)	Rated operational current (I _e)	Nominal sensing distance (S _n) ± 10%	ORDERING REFERENCES		
												PNP (positive switching)		
I-11	• Flush mounting	-	40	12	8	60	6-8B-10	M8 x 1	4	200	1,5			
I-11	• Non flush mounting	5	35	12	8	60	6-8B-10	M8 x 1	3	200	2,5	DCA8/4309KS	DCA8/43C9KS	DCA8/4329KS
												DCA8/5309KS	DCA8/53C9KS	DCA8/5329KS
I-7	• Flush mounting	-	43	15	8	66	6-8B-10	M12 x 1	2	200	2			
I-7	• Non flush mounting	7	36	15	8	66	6-8B-10	M12 x 1	1,5	200	4	DCA12/4309KS	DCA12/43C9KS	DCA12/4329KS
												DCA12/5309KS	DCA12/53C9KS	DCA12/5329KS

NPN (negative switching)

Use the above mentioned part number changing the last number 9 with 8 (ie DCA8/4308KS)

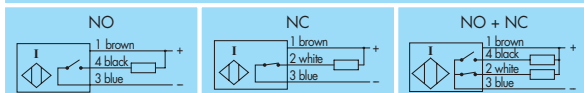

CYLINDRICAL INDUCTIVE SENSORS IN METAL HOUSING

- Diameters 18 - 30 - 45 mm
- Amplified in d.c.
- Connector output M12 x 1

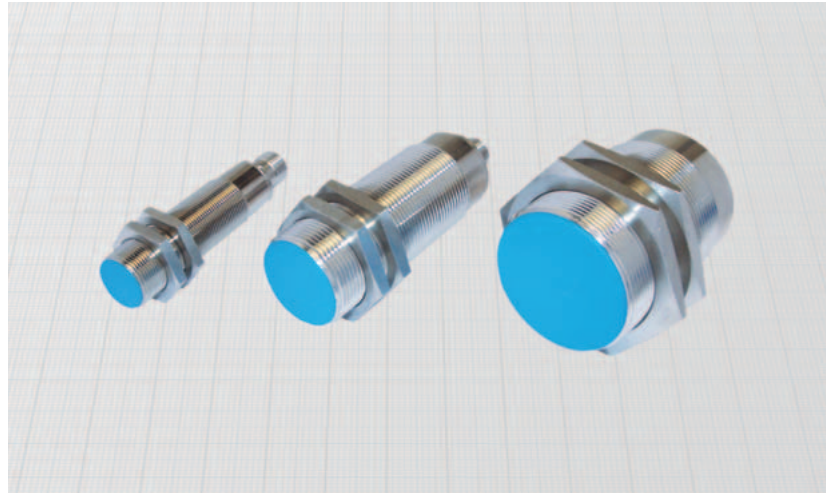
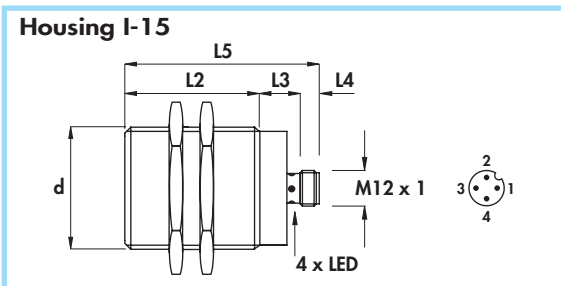
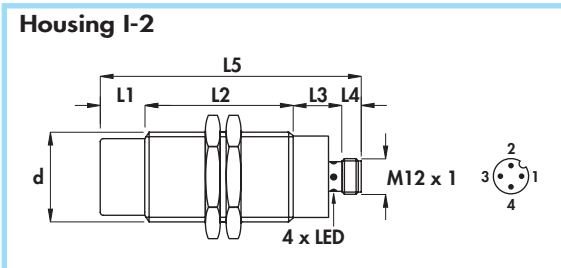
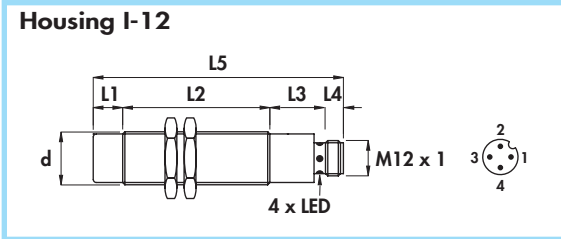

Diameter	M18 x 1	M30 x 1,5	M45 x 1,5
Nut	Size	SW24	SW36
	Thickness mm	4	5
Max tightening torque Nm	35	80	70

Materials:

- Housing: nickel plated brass
- Sensing face: plastic

Technical data:

- Supply voltage (U_B):
 - diameter 18 mm $5 \div 60$ Vdc
 - diameters 30 and 45 mm $7 \div 60$ Vdc
- Max ripple: 10%
- No-load supply current (I_0): ≤ 10 mA
- Voltage drop (U_d): $\leq 2,2$ V
- Temperature range: $-25^\circ \div +75^\circ\text{C}$
- Max thermal drift of sensing distance S_T : $\pm 10\%$
- Repeat accuracy (R): 2%
- Switching hysteresis (H): 10%
- Degree of protection: IP67
- Switch status indicator: yellow LED
- Protected against short-circuit and overload
- Protected against any wrong connection
- Suppression of initial false impulse
- Electromagnetic compatibility (EMC) according to EN60947-5-2
- Shock and vibration resistance according to EN60068-2-27 EN60068-2-6

Housing	Flush mounting Non flush mounting	L1	L2	L3	L4	L5	Female connector	Body diameter (d)	Max switching frequency (f)	Rated operational current (I _e)	Nominal sensing distance (S _n) ±10%	ORDERING REFERENCES					
		mm	mm	mm	mm	mm						PNP (positive switching)					
I-12	•	-	50	19	8	77	6-8B-10	M18 x 1	1	400	5				DCA18/4309KS	DCA18/43C9KS	DCA18/4329KS
I-12	•	10	50	19	8	87	6-8B-10	M18 x 1	1	400	8				DCA18/5309KS	DCA18/53C9KS	DCA18/5329KS
I-2	•	-	65	17	8	90	6-8B-10	M30 x 1,5	0,8	400	10				DCA30/4309KS	DCA30/43C9KS	DCA30/4329KS
I-2	•	15	50	17	8	90	6-8B-10	M30 x 1,5	0,4	400	15				DCA30/5309KS	DCA30/53C9KS	DCA30/5329KS
I-15	•	-	50	19	8	77	6-8B-10	M45 x 1,5	0,15	400	20				DCA45/4309KS	DCA45/43C9KS	DCA45/4329KS

NPN (negative switching)

Use the above mentioned part number changing the last number 9 with 8 (ie DCA18/4308KS)

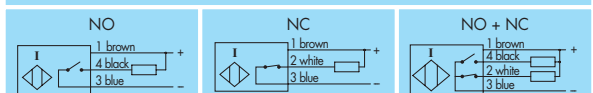

CYLINDRICAL INDUCTIVE SENSORS IN METAL HOUSING

- Diameter 18 mm •
- Amplified in d.c. •
- Connector output C1 - C2 •

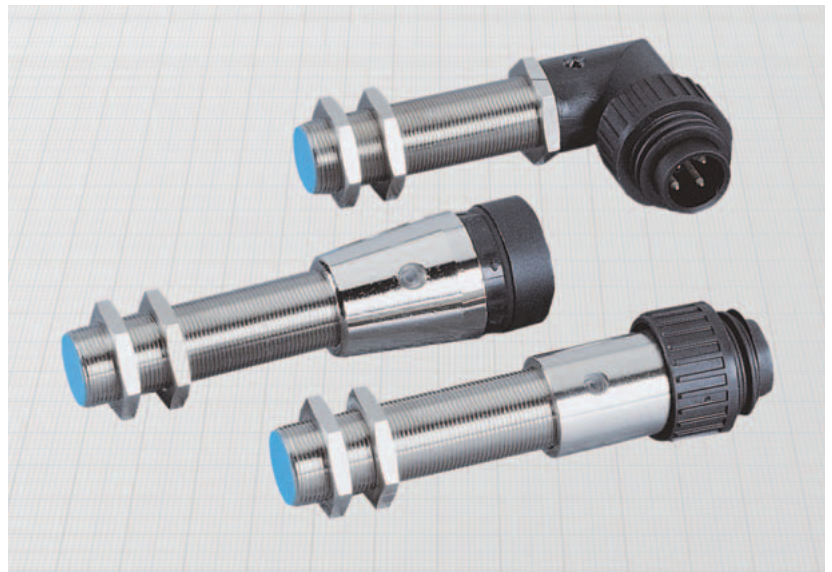
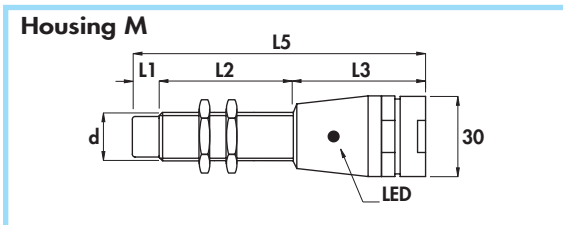
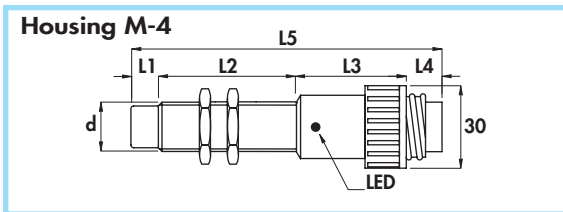
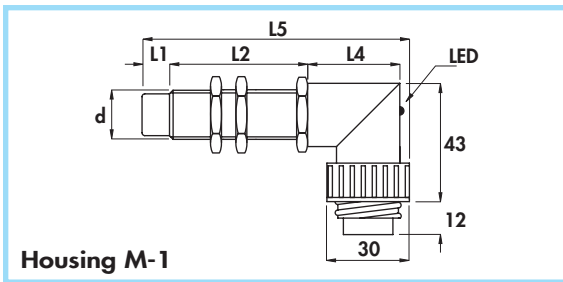

Diameter	M18 x 1	
Nut	Size	SW24
	Thickness mm	4
Max tightening torque Nm	35	

Materials:

- Housing: nickel plated brass
- Sensing face and socket connector: plastic

Technical data:

- Supply voltage (U_B): $5 \div 60$ Vdc
- Max ripple: 10%
- No-load supply current (I_0): ≤ 10 mA
- Voltage drop (U_d): $\leq 2,2$ V
- Temperature range: $-25^\circ \div +75^\circ$ C
- Max thermal drift of sensing distance S_T : $\pm 10\%$
- Repeat accuracy (R): 2%
- Switching hysteresis (H): 10%
- Degree of protection: IP65
- Switch status indicator: yellow LED
- Protected against short-circuit and overload
- Protected against any wrong connection
- Suppression of initial false impulse
- Electromagnetic compatibility (EMC) according to EN60947-5-2
- Shock and vibration resistance according to EN60068-2-27 EN60068-2-6

Housing	Mounting	L1	L2	L3	L4	L5	Female connector	Body diameter (d)	Max switching frequency (f)	Rated operational current (I _e)	Nominal sensing distance (S _T) ±10%	ORDERING REFERENCES	
												PNP (positive switching)	
M-1	Flush mounting	-	60	-	33	96	1	M18 x 1	1	400	5		
M-4	Non flush mounting	-	60	40	13	113	1	M18 x 1	1	400	5	DCA18/4209KS	DCA18/4219KS
M-1	•	10	50	-	33	96	1	M18 x 1	1	400	8	DCA18/4409KS	DCA18/4419KS
M-4	•	10	50	40	13	113	1	M18 x 1	1	400	8	DCA18/5209KS	DCA18/5219KS
												DCA18/5409KS	DCA18/5419KS

NPN (negative switching)
Use the above mentioned part number changing the last number 9 with 8 (ie DCA18/4208KS)

NO		NC	

PNP (positive switching)

NO		NC		NO + NC										
M	•	-	60	50	-	110	2	M18 x 1	1	400	5	DCA18/4E09KS	DCA18/4E19KS	DCA18/4E29KS
M	•	10	50	50	-	110	2	M18 x 1	1	400	8	DCA18/5E09KS	DCA18/5E19KS	DCA18/5E29KS

NPN (negative switching)
Use the above mentioned part number changing the last number 9 with 8 (ie DCA18/4E08KS)

NO		NC		NO + NC	

CYLINDRICAL INDUCTIVE SENSORS IN METAL HOUSING

- Diameter 30 mm
- Amplified in d.c.
- Connector output C1 - C2

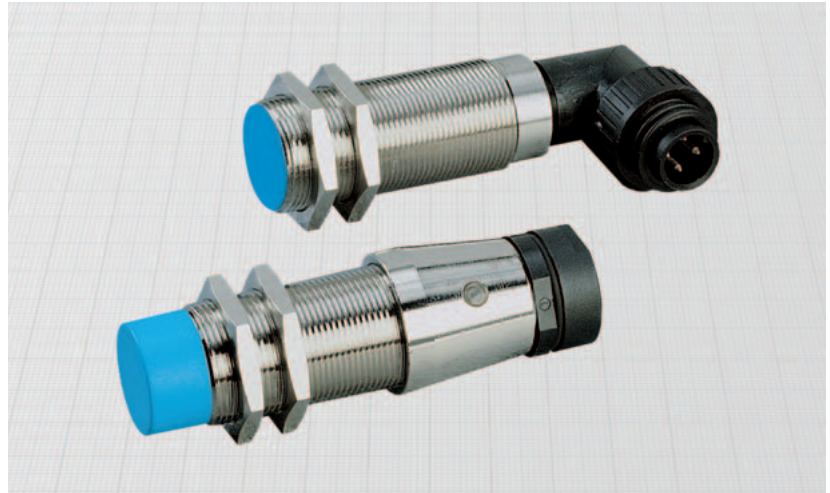
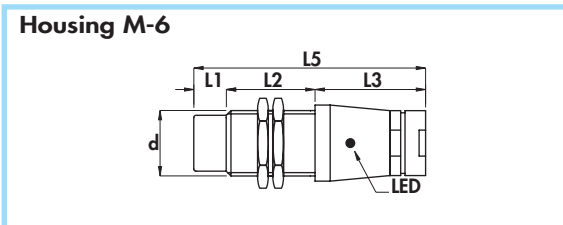
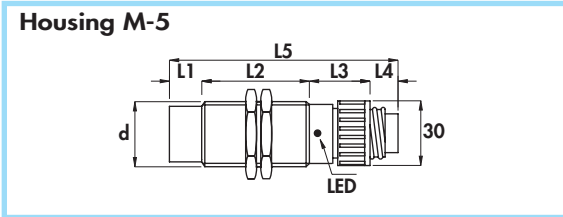
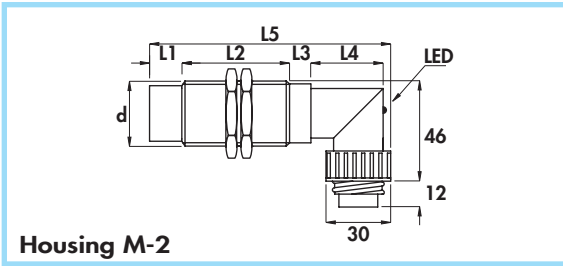

Diameter	M30 x 1,5	
Nut	Size	SW36
	Thickness mm	5
Max tightening torque Nm	80	

Materials:

- Housing: nickel plated brass
- Sensing face and socket connector: plastic

Technical data:

- Supply voltage (U_b): 7 ÷ 60 Vdc
- Max ripple: 10%
- No-load supply current (I_o): ≤ 10 mA
- Voltage drop (U_d): ≤ 2,2 V
- Temperature range: - 25° ÷ + 75°C
- Max thermal drift of sensing distance S_T : ± 10%
- Repeat accuracy (R): 2%
- Switching hysteresis (H): 10%
- Degree of protection: IP65
- Switch status indicator: yellow LED
- Protected against short-circuit and overload
- Protected against any wrong connection
- Suppression of initial false impulse
- Electromagnetic compatibility (EMC) according to EN60947-5-2
- Shock and vibration resistance according to EN60068-2-27 EN60068-2-6

Housing	Flush mounting Non flush mounting	L1	L2	L3	L4	L5	Female connector	Body diameter (d)	Max switching frequency (f)	No-load supply current (I _o)	Nominal sensing distance (S _T) ±10%	ORDERING REFERENCES	
		mm	mm	mm	mm	mm						n°	mm
M-2	•	-	65	10	40	115	1	M30 x 1,5	0,8	400	10		
M-5	•	-	65	28	13	106	1	M30 x 1,5	0,8	400	10	DCA30/4209KS	DCA30/4219KS
M-2	•	15	50	10	40	115	1	M30 x 1,5	0,4	400	15	DCA30/4409KS	DCA30/4419KS
M-5	•	15	50	28	13	106	1	M30 x 1,5	0,4	400	15	DCA30/5209KS	DCA30/5219KS
												DCA30/5409KS	DCA30/5419KS

NPN (negative switching)

Use the above mentioned part number changing the last number 9 with 8 (ie DCA30/4208KS)



PNP (positive switching)

Housing	Flush mounting Non flush mounting	L1	L2	L3	L4	L5	Female connector	Body diameter (d)	Max switching frequency (f)	No-load supply current (I _o)	Nominal sensing distance (S _T) ±10%	ORDERING REFERENCES		
		mm	mm	mm	mm	mm						n°	mm	KHz
M-6	•	-	56	51	-	107	2	M30 x 1,5	0,8	400	10			
M-6	•	15	41	51	-	107	2	M30 x 1,5	0,4	400	15	DCA30/4E09KS	DCA30/4E19KS	DCA30/4E29KS
												DCA30/5E09KS	DCA30/5E19KS	DCA30/5E29KS

NPN (negative switching)

Use the above mentioned part number changing the last number 9 with 8 (ie. DCA30/4E08KS)

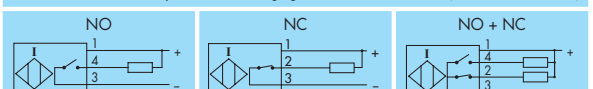

Diameter 45 mm •
 Amplified in d.c. •
 Connector output C1 - C2 •

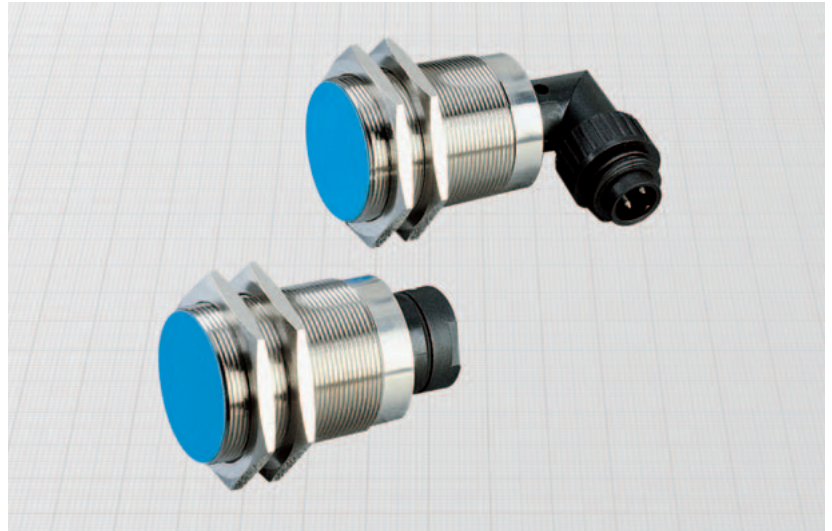
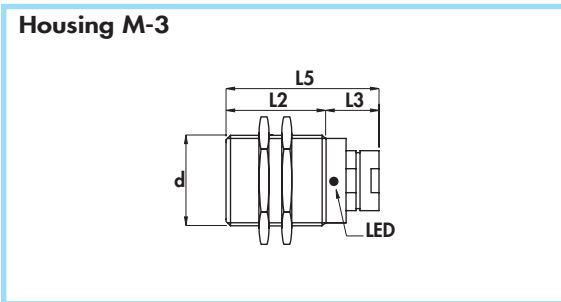
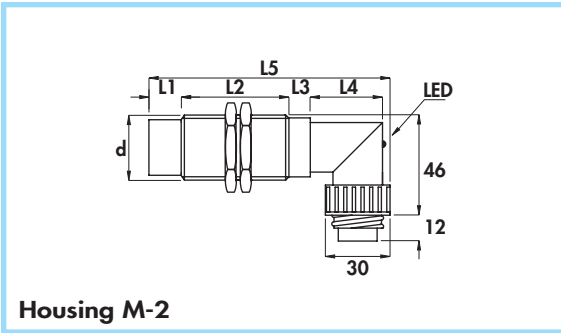

Diameter	M45 x 1,5	
Nut	Size	SW55
	Thickness mm	5
Max tightening torque Nm	70	

Materials:

- Housing: nickel plated brass
- Sensing face and socket connector: plastic

Technical data:

- Supply voltage (U_B): 7 ÷ 60 Vdc
- Max ripple: 10%
- No-load supply current (I_0): ≤ 10 mA
- Voltage drop (U_d): ≤ 2,2 V
- Temperature range: -25° ÷ +75°C
- Max thermal drift of sensing distance S_T : ± 10%
- Repeat accuracy (R): 2%
- Switching hysteresis (H): 10%
- Degree of protection: IP65
- Switch status indicator: yellow LED
- Protected against short-circuit and overload
- Protected against any wrong connection
- Suppression of initial false impulse
- Electromagnetic compatibility (EMC) according to EN60947-5-2
- Shock and vibration resistance according to EN60068-2-27 EN60068-2-6

Housing	Flush mounting Non flush mounting	L1	L2	L3	L4	L5	Female connector	Body diameter (d)	Max switching frequency (f)	Rated operational current (I _e)	Nominal sensing distance (S _T) ± 10%	ORDERING REFERENCES		
												PNP (positive switching)		
M-2	•	-	50	10	42	102	1	M45 x 1,5	0,15	400	20			
												DCA45/4209KS	DCA45/4219KS	
												NPN (negative switching) Use the above mentioned part number changing the last number 9 with 8 (ie DCA45/4208KS)		
												PNP (positive switching)		
M-3	•	-	50	28	-	78	2	M45 x 1,5	0,15	400	20	DCA45/4E09KS	DCA45/4E19KS	DCA45/4E29KS
												NPN (negative switching) Use the above mentioned part number changing the last number 9 with 8 (ie DCA45/4E08KS)		

CYLINDRICAL INDUCTIVE SENSORS IN METAL HOUSING

- **SHORT SERIES**
- **Amplified in d.c. 3 wires**
- **Cable output**

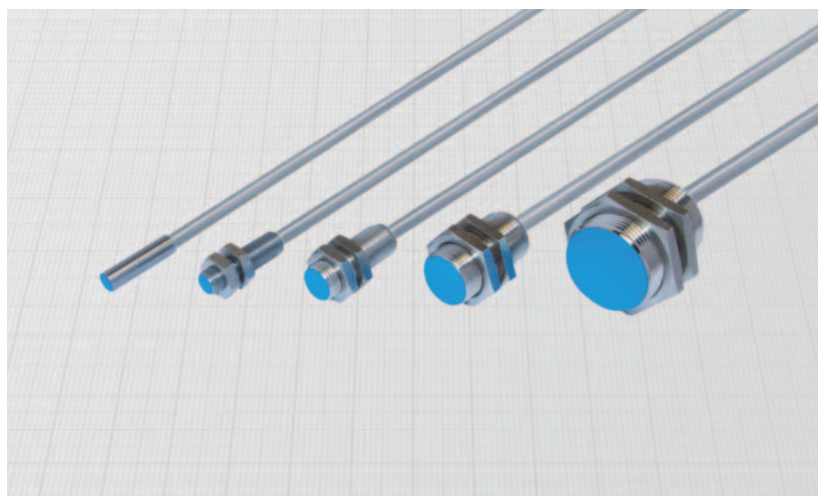
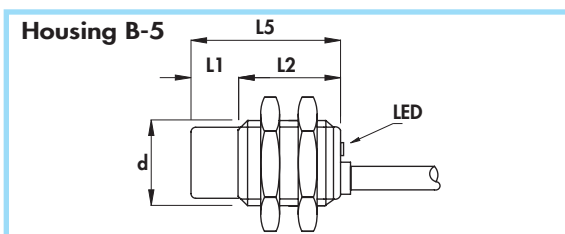
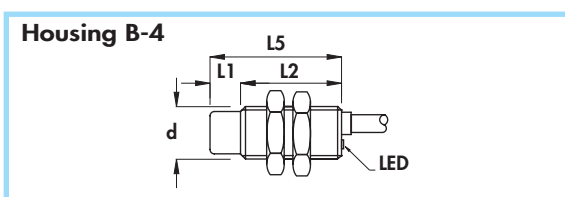
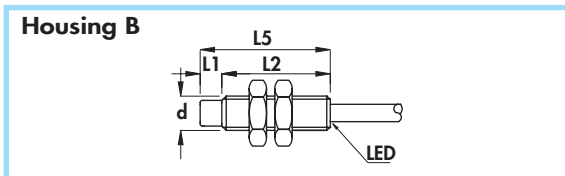
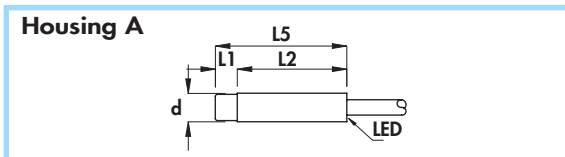

Diameter		M8 x 1	M12 x 1	M18 x 1	M30 x 1,5
Nut	Size	SW13	SW17	SW24	SW36
	Thickness mm	4	4	4	5
Max tightening torque Nm		10	15	35	80

Materials:

- Cable: 2 m PVC CEI 20 - 22 II; 90°C; 300 V; O.R.
- Housing 6,5 and 8 mm: stainless steel
- Housing 12 ÷ 30 mm: nickel plated brass
- Sensing face: plastic

Technical data:

- Supply voltage (U_B): see ordering references
- Max ripple: 10%
- No-load supply current (I_0): ≤ 10 mA
- Voltage drop (U_d): $\leq 1,5$ V
- Temperature range: $-25^\circ \div +70^\circ\text{C}$
- Max thermal drift of sensing distance S_s : $\pm 10\%$
- Repeat accuracy (R): 2%
- Switching hysteresis (H): 10%
- Degree of protection: IP67
- Switch status indicator: yellow LED
- Cable conductor cross section: 0,22 mm² on 6,5 and 8 mm
0,35 mm² on 12 mm
0,50 mm² on 18 and 30 mm

- Protected against short-circuit and overload
- Protected against any wrong connection
- Suppression of initial false impulse
- Electromagnetic compatibility (EMC) according to EN60947-5-2
- Shock and vibration resistance according to EN60068-2-27 EN60068-2-6

Housing	Flush mounting Non flush mounting	L1	L2	L3	L4	L5	Cable diameter	Body diameter (d)	Supply voltage (U_B)	Max switching frequency (f)	No-load supply current (I_0)	Nominal sensing distance ($S_n \pm 10\%$)	ORDERING REFERENCES	
													PNP (positive switching)	
A	•	-	30	-	-	30	3,5	6,5	7 ÷ 30	4	200	1,5		
A	•	5	25	-	-	30	3,5	6,5	7 ÷ 30	3	200	2,5	DSA6,5/4609LKS DSA6,5/5609LKS	DSA6,5/4619LKS DSA6,5/5619LKS
B	•	-	30	-	-	30	3,5	M8 x 1	7 ÷ 30	4	200	1,5	DSA8/4609KS	DSA8/4619KS
B	•	5	25	-	-	30	3,5	M8 x 1	7 ÷ 30	3	200	2,5	DSA8/5609KS	DSA8/5619KS
B-4	•	-	30	-	-	30	4	M12 x 1	7 ÷ 40	2	200	2	DSA12/4609KS	DSA12/4619KS
B-4	•	7	23	-	-	30	4	M12 x 1	7 ÷ 40	1,5	200	4	DSA12/5609KS	DSA12/5619KS
B-5	•	-	30	-	-	30	5	M18 x 1	5 ÷ 40	0,8	200	5	DSA18/4609KS	DSA18/4619KS
B-5	•	10	20	-	-	30	5	M18 x 1	5 ÷ 40	0,6	200	8	DSA18/5609KS	DSA18/5619KS
B-5	•	-	35	-	-	35	6	M30 x 1,5	7 ÷ 40	0,8	200	10	DSA30/4609KS	DSA30/4619KS
B-5	•	15	20	-	-	35	6	M30 x 1,5	7 ÷ 40	0,4	200	15	DSA30/5609KS	DSA30/5619KS

NPN (negative switching)

Use the above mentioned part number changing the last number 9 with 8 (ie. DSA6,5/4608LKS)

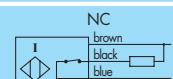
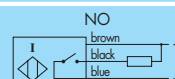

**SHORT SERIES - diameters 6,5 - 8 mm •
Amplified in d.c. •
Connector output M8 x 1 •**

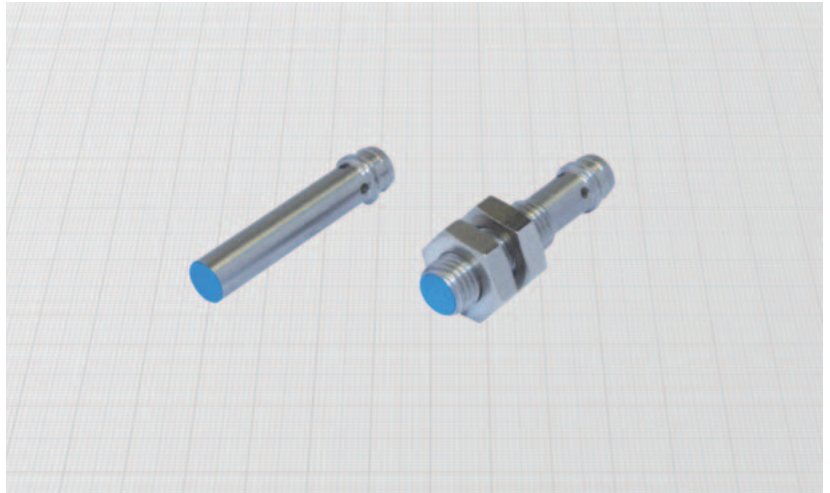
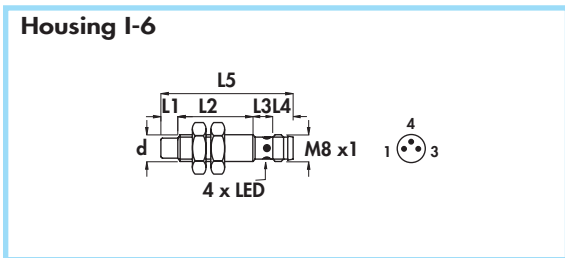
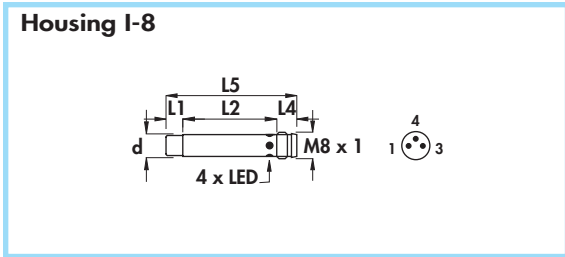

Diameter	M8 x 1	
Nut	Size	SW13
	Thickness mm	4
Max tightening torque Nm	10	

Materials:

- Housing: stainless steel
- Sensing face: plastic

Technical data:

- Supply voltage (U_B): $7 \div 30$ Vdc
- Max ripple: 10%
- No-load supply current (I_0): ≤ 10 mA
- Voltage drop (U_d): $\leq 1,5$ V
- Temperature range: $-25^\circ \div +70^\circ\text{C}$
- Max thermal drift of sensing distance S_r : $\pm 10\%$
- Repeat accuracy (R): 2%
- Switching hysteresis (H): 10%
- Degree of protection: IP67
- Switch status indicator: yellow LED
- Protected against short-circuit and overload
- Protected against any wrong connection
- Suppression of initial false impulse
- Electromagnetic compatibility (EMC) according to EN60947-5-2
- Shock and vibration resistance according to EN60068-2-27 EN60068-2-6

Housing	Flush mounting Non flush mounting	L1	L2	L3	L4	L5	Female connector	Body diameter (d)	Max switching frequency (f)	Rated operational current (I _e)	Nominal sensing distance (S _n) ± 10%	ORDERING REFERENCES	
												PNP (positive switching)	
												NO	NC
I-8	•	-	29,5	-	5,5	35	11 - 12	6,5	4	200	1,5		
I-8	•	5	24,5	-	5,5	35	11 - 12	6,5	3	200	2,5	DSA6,5/4909LKS DSA6,5/5909LKS	DSA6,5/4919LKS DSA6,5/5919LKS
I-6	•	-	21	8,5	5,5	35	11 - 12	M8 x 1	4	200	1,5		
I-6	•	5	16	8,5	5,5	35	11 - 12	M8 x 1	3	200	2,5	DSA8/4909KS DSA8/5909KS	DSA8/4919KS DSA8/5919KS
												NPN (negative switching)	
												Use the above mentioned part number changing the last number 9 with 8 (ie. DCA45/4E08KS)	

CYLINDRICAL INDUCTIVE SENSORS IN METAL HOUSING

- **SHORT SERIES** - diameters 8 - 12 - 18 - 30 mm
- **Amplified in d.c.**
- Connector output M12 x 1

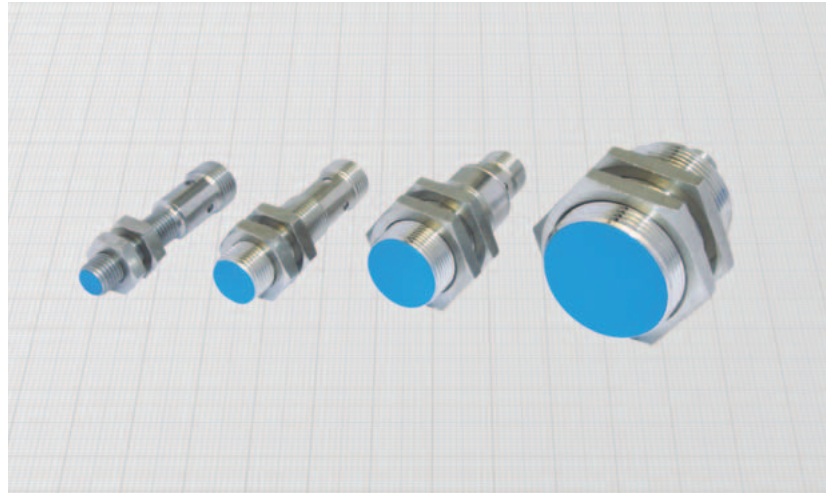
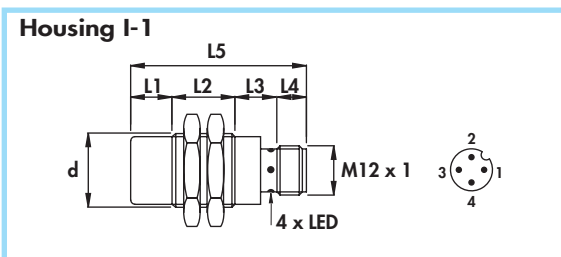
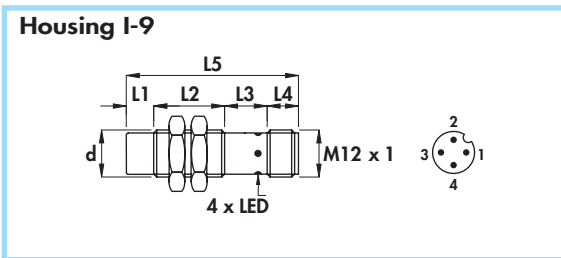
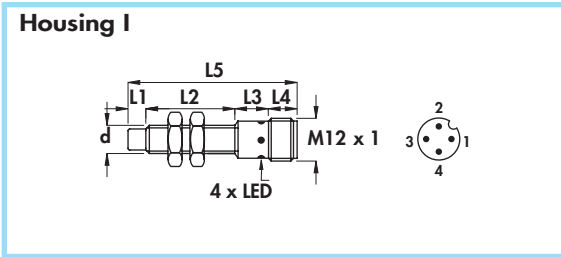

Diameter	M8 x 1	M12 x 1	M18 x 1	M30 x 1,5	
Nut	Size	SW13	SW17	SW24	SW36
	Thickness mm	4	4	4	5
Max tightening torque Nm	10	15	35	80	

Materials:

- Housing 8 mm: stainless steel
- Housing 12 ÷ 30 mm: nickel plated brass
- Sensing face: plastic

Technical data:

- Supply voltage (U_b): see ordering references
- Max ripple: 10%
- No-load supply current (I_o): ≤ 10 mA
- Voltage drop (U_d): $\leq 1,5$ V
- Temperature range: $-25^\circ \div +70^\circ$ C
- Max thermal drift of sensing distance S_T : $\pm 10\%$
- Repeat accuracy (R): 2%
- Switching hysteresis (H): 10%
- Degree of protection: IP67
- Switch status indicator: yellow LED
- Protected against short-circuit and overload
- Protected against any wrong connection
- Suppression of initial false impulse
- Electromagnetic compatibility (EMC) according to EN60947-5-2
- Shock and vibration resistance according to EN60068-2-27 EN60068-2-6

Housing	Flush mounting Non flush mounting	L1	L2	L3	L4	L5	Female connector	Body diameter (d)	Supply voltage (U_b)	Max switching frequency (f)	Rated operational current (I_e)	Nominal sensing distance (S_n) $\pm 10\%$	ORDERING REFERENCES	
													PNP (positive switching)	
		mm	mm	mm	mm	mm	n°	mm	V (min - max)	KHz	mA	mm	NO	NC
I	•	-	26	13	8	47	6-8B-10	M8 x 1	7 ÷ 30	4	200	1,5		
	•	5	21	13	8	47	6-8B-10	M8 x 1	7 ÷ 30	3	200	2,5		
I-9	•	-	30	10	8	48	6-8B-10	M12 x 1	7 ÷ 40	2	200	2		
	•	7	23	10	8	48	6-8B-10	M12 x 1	7 ÷ 40	1	200	4		
I-1	•	-	25	16	8	49	6-8B-10	M18 x 1	5 ÷ 40	0,8	200	5		
	•	10	15	16	8	49	6-8B-10	M18 x 1	5 ÷ 40	0,6	200	8		
I-1	•	-	25	17	8	50	6-8B-10	M30 x 1,5	7 ÷ 40	0,8	200	10		
	•	15	25	17	8	65	6-8B-10	M30 x 1,5	7 ÷ 40	0,4	200	15		

NPN (negative switching)

Use the above mentioned part number changing the last number 9 with 8 (ie. DSA8/4308KS)



Extended sensing distance - diameters 8 - 12 mm •
Amplified in d.c. 3 wires •
Cable output •

Housing B-6

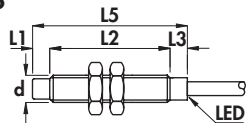

Housing B-3

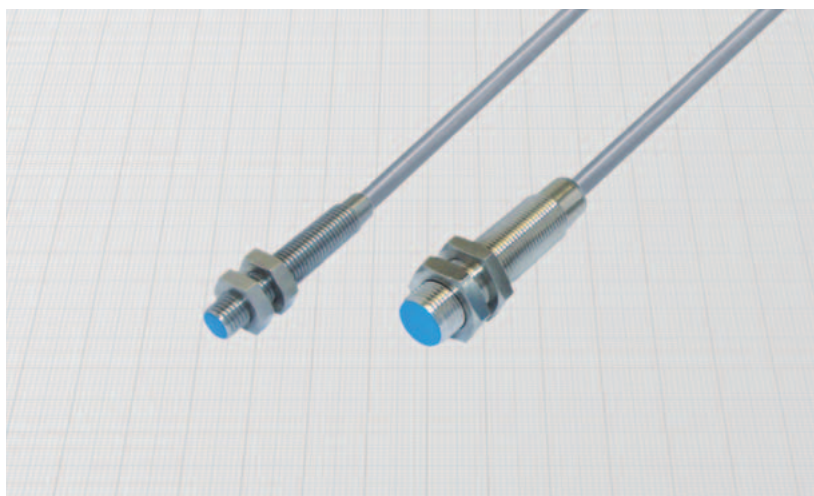
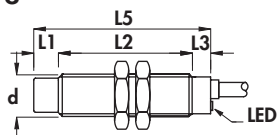

Diameter	M8 x 1	M12 x 1
Nut	Size	SW13
	Thkns mm	4
Max tightening torque Nm	10	15

Materials:

- Cable: 2 m PVC CEI 20 - 22 II; 90°C; 300 V; O.R.
- Housing 8 mm: stainless steel
- Housing 12 mm: nickel plated brass
- Sensing face: plastic

Technical data:

- Supply voltage (U_B): see ordering references
- Max ripple: 10%
- No-load supply current (I_0): ≤ 10 mA
- Voltage drop (U_d): $\leq 1,5$ V
- Temperature range: $-20^\circ \div +70^\circ\text{C}$
- Max thermal drift of sensing distance S_T : $\pm 10\%$
- Repeat accuracy (R): 4%
- Switching hysteresis (H): 10%
- Degree of protection: IP67
- Switch status indicator: yellow LED
- Cable conductor cross section: 0,22 mm² on 8 mm
0,35 mm² on 12 mm
- Protected against short-circuit and overload
- Protected against any wrong connection
- Suppression of initial false impulse
- Electromagnetic compatibility (EMC) according to EN60947-5-2
- Shock and vibration resistance according to EN60068-2-27 EN60068-2-6

Housing	Flush mounting (*) Non flush mounting	L1	L2	L3	L4	L5	Cable diameter	Body diameter (d)	Supply voltage (U_B)	Max switching frequency (f)	Rated operational current (I_e)	Nominal sensing distance (S_n) $\pm 10\%$	ORDERING REFERENCES	
													PNP (positive switching)	
		mm	mm	mm	mm	mm	mm	V (min - max)	Hz	mA	mm			
B-6	•	-	40	5	-	45	3,5	M8 x 1	7÷30	800	200	2	DCAE8/4609KS	DCAE8/4619KS
B-6	•	-	40	5	-	45	3,5	M8 x 1	7÷30	800	200	2,5	DCE8/4609KS	DCE8/4619KS
B-6	•	5	35	5	-	45	3,5	M8 x 1	7÷30	400	200	3	DCAE8/5609KS	DCAE8/5619KS
B-6	•	5	35	5	-	45	3,5	M8 x 1	7÷30	400	200	3,5	DCE8/5609KS	DCE8/5619KS
B-3	•	-	43	7	-	50	4	M12 x 1	7÷40	800	200	3	DCAE12/4609KS	DCAE12/4619KS
B-3	•	-	43	7	-	50	4	M12 x 1	7÷40	800	200	4	DCE12/4609KS	DCE12/4619KS
B-3	•	7	36	7	-	50	4	M12 x 1	7÷40	600	200	5	DCAE12/5609KS	DCAE12/5619KS
B-3	•	7	36	7	-	50	4	M12 x 1	7÷40	600	200	6	DCE12/5609KS	DCE12/5619KS

(*) Note: See mounting precautions (pag. 22)

NPN (negative switching)
 Use the above mentioned part number changing the last number 9 with 8 (ie. DCE8/4608KS)



CYLINDRICAL INDUCTIVE SENSORS IN METAL HOUSING

- Extended sensing distance - diameters 18 - 30 mm
- Amplified in d.c. 3 wires
- Cable output

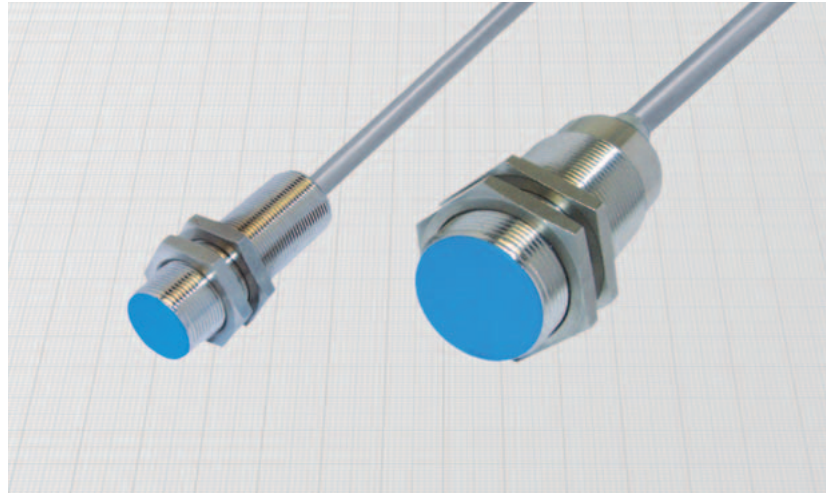
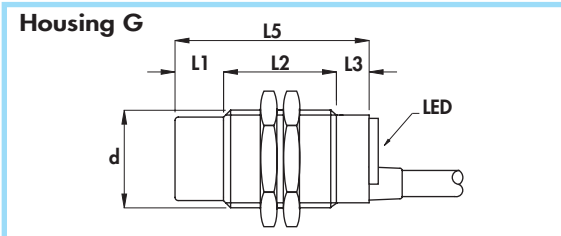
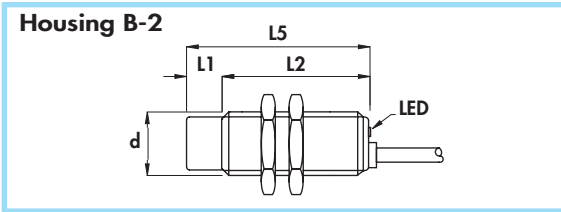

Diameter		M18 x 1	M30 x 1,5
Nut	Size	SW24	SW36
	Thkns mm	4	5
Max tightening torque Nm		35	80

Materials:

- Cable: 2 m PVC CEI 20 - 22 II; 90°C; 300 V; O.R.
- Housing: nickel plated brass
- Sensing face: plastic

Technical data:

- Supply voltage (U_B): see ordering references
- Max ripple: 10%
- No-load supply current (I_0): ≤ 10 mA
- Voltage drop (U_d): $\leq 1,5$ V
- Temperature range: $-20^\circ \div +70^\circ\text{C}$
- Max thermal drift of sensing distance S_s : $\pm 10\%$
- Repeat accuracy (R): 4%
- Switching hysteresis (H): 10%
- Degree of protection: IP67
- Switch status indicator: yellow LED
- Cable conductor cross section: $0,50$ mm²
- Protected against short-circuit and overload
- Protected against any wrong connection
- Suppression of initial false impulse
- Electromagnetic compatibility (EMC) according to EN60947-5-2
- Shock and vibration resistance according to EN60068-2-27 EN60068-2-6

Housing	Flush mounting (*) Non flush mounting	L1	L2	L3	L4	L5	Cable diameter	Body diameter (d)	Supply voltage (U_B)	Max switching frequency (f)	Rated operational current (I_e)	Nominal sensing distance (S_n) $\pm 10\%$	ORDERING REFERENCES	
													PNP (positive switching)	
B - 2	•	-	50	-	-	50	5	M18 x 1	7÷40	300	200	8		
B - 2	•	-	50	-	-	50	5	M18 x 1	7÷40	300	200	10	DCAE18/4A09KS	DCAE18/4A19KS
B - 2	•	10	40	-	-	50	5	M18 x 1	7÷40	200	200	12	DCE18/4A09KS	DCE18/4A19KS
B - 2	•	10	40	-	-	50	5	M18 x 1	7÷40	200	200	14	DCAE18/5A09KS	DCAE18/5A19KS
B - 2	•	10	40	-	-	50	5	M18 x 1	7÷40	200	200	14	DCE18/5A09KS	DCE18/5A19KS
G	•	-	50	10	-	60	6	M30 x 1,5	7÷40	100	200	15	DCAE30/4609KS	DCAE30/4619KS
G	•	-	50	10	-	60	6	M30 x 1,5	7÷40	100	200	20	DCE30/4609KS	DCE30/4619KS
G	•	15	35	10	-	60	6	M30 x 1,5	7÷40	100	200	20	DCAE30/5609KS	DCAE30/5619KS
G	•	15	35	10	-	60	6	M30 x 1,5	7÷40	100	200	28	DCE30/5609KS	DCE30/5619KS

(*) Note: See mounting precautions (pag. 22)

NPN (negative switching)

Use the above mentioned part number changing the last number 9 with 8 (ie. DCE8/4608KS)

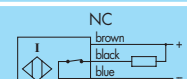
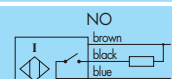

- Extended sensing distance •
- Amplified in d.c. •
- Connector output M8 x 1 •

Housing I-5

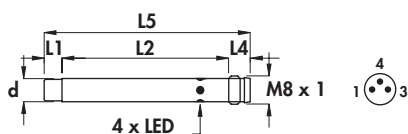

Housing I-10

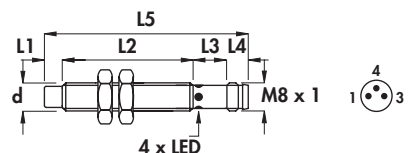

Diameter	M8 x 1	
Nut	Size	SW13
	Thickness mm	4
Max tightening torque Nm	10	

Materials:

- Housing: stainless steel
- Sensing face: plastic

Technical data:

- Supply voltage (U_B): 7 ÷ 30 Vdc
- Max ripple: 10%
- No-load supply current (I_0): ≤ 10 mA
- Voltage drop (U_d): ≤ 1,5 V
- Temperature range: -20° ÷ +70°C
- Max thermal drift of sensing distance S_T : ± 10%
- Repeat accuracy (R): 4%
- Switching hysteresis (H): 10%
- Degree of protection: IP67
- Switch status indicator: yellow LED
- Protected against short-circuit and overload
- Protected against any wrong connection
- Suppression of initial false impulse
- Electromagnetic compatibility (EMC) according to EN60947-5-2
- Shock and vibration resistance according to EN60068-2-27 EN60068-2-6

Housing	Flush mounting (*) Non flush mounting	L1	L2	L3	L4	L5	Female connector	Body diameter (d)	Max switching frequency (f)	Rated operational current (I _e)	Nominal sensing distance (S _n) ± 10%	ORDERING REFERENCES	
												PNP (positive switching)	
I-5	•	-	48,5	-	5,5	54	11 - 12	6,5	800	200	2		
I-5	•	-	48,5	-	5,5	54	11 - 12	6,5	800	200	2,5	DCAE6,5/4909LKS	DCAE6,5/4919LKS
I-5	•	5	43,5	-	5,5	54	11 - 12	6,5	400	200	3	DCE6,5/4909LKS	DCE6,5/4919LKS
I-5	•	5	43,5	-	5,5	54	11 - 12	6,5	400	200	3,5	DCAE6,5/5909LKS	DCAE6,5/5919LKS
I-5	•	5	43,5	-	5,5	54	11 - 12	6,5	400	200	3,5	DCE6,5/5909LKS	DCE6,5/5919LKS
I-10	•	-	40	8,5	5,5	54	11 - 12	M8 x 1	800	200	2	DCAE8/4909KS	DCAE8/4919KS
I-10	•	-	40	8,5	5,5	54	11 - 12	M8 x 1	800	200	2,5	DCE8/4909KS	DCE8/4919KS
I-10	•	5	35	8,5	5,5	54	11 - 12	M8 x 1	400	200	3	DCAE8/5909KS	DCAE8/5919KS
I-10	•	5	35	8,5	5,5	54	11 - 12	M8 x 1	400	200	3,5	DCE8/5909KS	DCE8/5919KS

(*) Note: See mounting precautions (pag. 22)

NPN (negative switching)
Use the above mentioned part number changing the last number 9 with 8 (ie. DCAE6,5/4908LKS)



CYLINDRICAL INDUCTIVE SENSORS IN METAL HOUSING

- Extended sensing distance - diameter 8 - 12 mm
- Amplified in d.c.
- Connector output M12 x 1

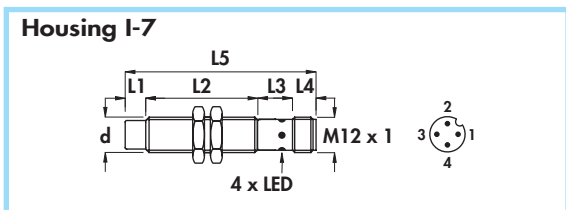
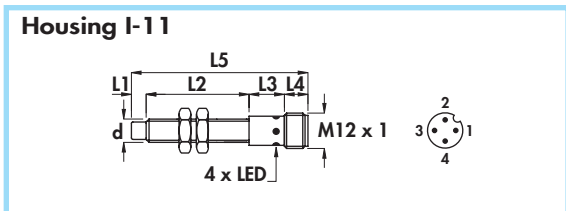

Diameter	M8 x 1	M12 x 1
Nut	Size	SW13
	Thkns mm	4
Max tightening torque Nm	10	15

Materials:

- Housing 8 mm: stainless steel
- Housing 12 mm: nickel plated brass
- Sensing face: plastic

Technical data:

- Supply voltage (U_B): see ordering references
- Max ripple: 10%
- Rated operational current (I_B): 200 mA
- No-load supply current (I_0): ≤ 10 mA
- Voltage drop (U_d): $\leq 1,5$ V
- Temperature range: $-20^\circ \div +70^\circ\text{C}$
- Max thermal drift of sensing distance S_T : $\pm 10\%$
- Repeat accuracy (R): 4%
- Switching hysteresis (H): 10%
- Degree of protection: IP67
- Switch status indicator: yellow LED
- Protected against short-circuit and overload
- Protected against any wrong connection
- Suppression of initial false impulse
- Electromagnetic compatibility (EMC) according to EN60947-5-2
- Shock and vibration resistance according to EN60068-2-27 EN60068-2-6

Housing	Flush mounting (*) Non flush mounting	L1	L2	L3	L4	L5	Female connector	Body diameter (d)	Supply voltage (U_B)	Max switching frequency (f)	Nominal sensing distance (S_n) $\pm 10\%$	ORDERING REFERENCES	
												PNP (positive switching)	
I-11	•	-	40	12	8	60	6-8B-10	M8 x 1	7 ÷ 30	800	2		
I-11	•	-	40	12	8	60	6-8B-10	M8 x 1	7 ÷ 30	800	2,5	DCAE8/4309KS	DCAE8/43C9KS
I-11	•	5	35	12	8	60	6-8B-10	M8 x 1	7 ÷ 30	400	3	DCE8/4309KS	DCE8/43C9KS
I-11	•	5	35	12	8	60	6-8B-10	M8 x 1	7 ÷ 30	400	3,5	DCAE8/5309KS	DCAE8/53C9KS
I-11	•	5	35	12	8	60	6-8B-10	M8 x 1	7 ÷ 30	400	3,5	DCE8/5309KS	DCE8/53C9KS
I-7	•	-	43	15	8	66	6-8B-10	M12 x 1	7 ÷ 40	800	3	DCAE12/4309KS	DCAE12/43C9KS
I-7	•	-	43	15	8	66	6-8B-10	M12 x 1	7 ÷ 40	800	4	DCE12/4309KS	DCE12/43C9KS
I-7	•	7	36	15	8	66	6-8B-10	M12 x 1	7 ÷ 40	600	5	DCAE12/5309KS	DCAE12/53C9KS
I-7	•	7	36	15	8	66	6-8B-10	M12 x 1	7 ÷ 40	600	6	DCE12/5309KS	DCE12/53C9KS

(*) Note: See mounting precautions (pag. 22)

NPN (negative switching)
Use the above mentioned part number changing the last number 9 with 8 (ie. DCE8/4308KS)

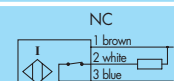
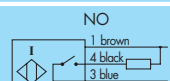

Extended sensing distance - diameters 18 - 30 mm •
 Amplified in d.c. •
 Connector output M12 x 1 •

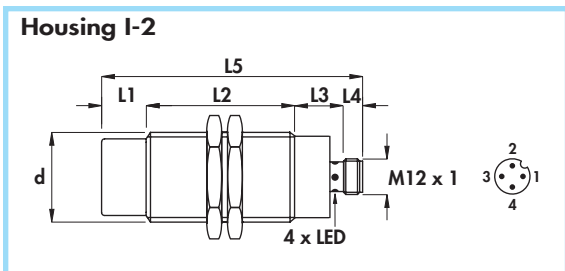
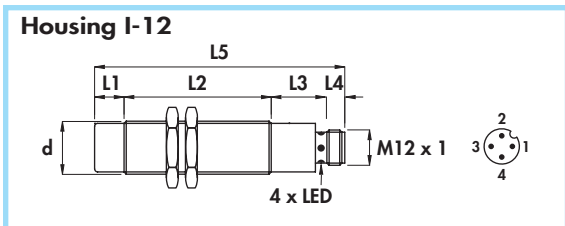

Diameter		M18 x 1	M30 x 1,5
Nut	Size	SW24	SW36
	Thkns mm	4	5
Max tightening torque Nm		35	80

Materials:

- Housing: nickel plated brass
- Sensing face: plastic

Technical data:

- Supply voltage (U_B): see ordering references
- Max ripple: 10%
- Rated operational current (I_B): 200 mA
- No-load supply current (I_0): ≤ 10 mA
- Voltage drop (U_d): $\leq 1,5$ V
- Temperature range: $-20^\circ \div +70^\circ\text{C}$
- Max thermal drift of sensing distance S_r : $\pm 10\%$
- Repeat accuracy (R): 4%
- Switching hysteresis (H): 10%
- Degree of protection: IP67
- Switch status indicator: yellow LED
- Protected against short-circuit and overload
- Protected against any wrong connection
- Suppression of initial false impulse
- Electromagnetic compatibility (EMC) according to EN60947-5-2
- Shock and vibration resistance according to EN60068-2-27 EN60068-2-6

Housing	Flush mounting (*) Non flush mounting	L1	L2	L3	L4	L5	Female connector	Body diameter (d)	Supply voltage (U_B)	Max switching frequency (f)	Nominal sensing distance (S_n) $\pm 10\%$	ORDERING REFERENCES	
												PNP (positive switching)	
I-12	•	-	50	19	8	77	6-8B-10	M18 x 1	7 ÷ 40	300	10		
I-12	•	-	50	19	8	77	6-8B-10	M18 x 1	7 ÷ 40	300	10		
I-12	•	10	50	19	8	87	6-8B-10	M18 x 1	7 ÷ 40	200	14		
I-12	•	10	50	19	8	87	6-8B-10	M18 x 1	7 ÷ 40	200	14		
I-2	•	-	65	17	8	90	6-8B-10	M30 x 1,5	7 ÷ 40	100	20		
I-2	•	-	65	17	8	90	6-8B-10	M30 x 1,5	7 ÷ 40	100	20		
I-2	•	15	50	17	8	90	6-8B-10	M30 x 1,5	7 ÷ 40	100	28		
I-2	•	15	50	17	8	90	6-8B-10	M30 x 1,5	7 ÷ 40	100	28		

(*) Note: See mounting precautions (pag. 22)

NPN (negative switching)	
Use the above mentioned part number changing the last number 9 with 8 (ie. DCE8/4308KS)	

CYLINDRICAL INDUCTIVE SENSORS IN METAL HOUSING

- **SHORT SERIES - Extended sensing distance**
- **Amplified in d.c. 3 wires**
- **Cable output**

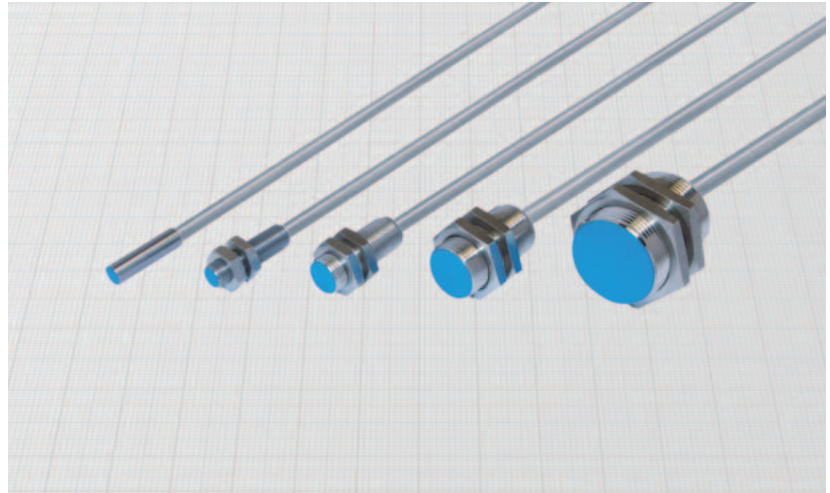
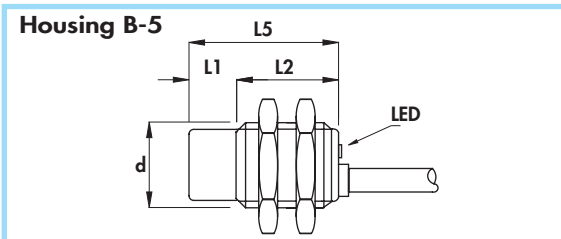
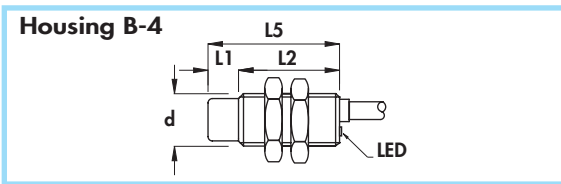
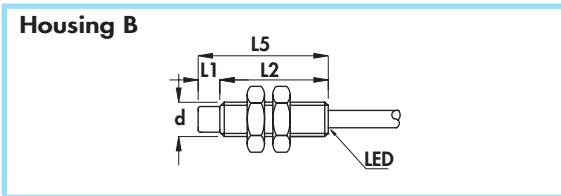
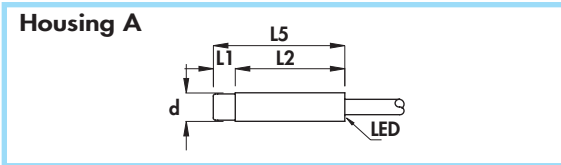

Diameter	M8 x 1	M12 x 1	M18 x 1	M30 x 1,5
Nut	Size	SW13	SW17	SW24
	Thickness mm	4	4	4
Max tightening torque Nm	10	15	35	80

Materials:

- Cable: 2 m PVC CEI 20 - 22 II; 90°C; 300 V; O.R.
- Housing 6,5 and 8 mm: stainless steel
- Housing 12 ÷ 30 mm: nickel plated brass
- Sensing face: plastic

Technical data:

- Supply voltage (U_b): see ordering references
- Max ripple: 10%
- No-load supply current (I_0): ≤ 10 mA
- Voltage drop (U_d): $\leq 1,5$ V
- Temperature range: $-20^\circ \div +70^\circ\text{C}$
- Max thermal drift of sensing distance S_T : $\pm 10\%$
- Repeat accuracy (R): 4%
- Switching hysteresis (H): 10%
- Degree of protection: IP67
- Switch status indicator: yellow LED
- Cable conductor cross section: 0,22 mm² on 6,5 and 8 mm
0,35 mm² on 12 mm
0,50 mm² on 18 and 30 mm

- Protected against short-circuit and overload
- Protected against any wrong connection
- Suppression of initial false impulse
- Electromagnetic compatibility (EMC) according to EN60947-5-2
- Shock and vibration resistance according to EN60068-2-27 EN60068-2-6

Housing	Flush mounting (*) Non flush mounting	L1	L2	L3	L4	L5	Cable diameter	Body diameter (d)	Supply voltage (U_b)	Max switching frequency (f)	Rated operational current (I_e)	Nominal sensing distance (S_n) $\pm 10\%$	ORDERING REFERENCES	
		mm	mm	mm	mm	PNP (positive switching)								
		NO brown black blue		NC brown black blue										
A	•	-	30	-	-	30	3,5	6,5	7 ÷ 30	800	200	2,5	DSE6,5/4609LKS	DSE6,5/4619LKS
B	•	-	30	-	-	30	3,5	M8 x 1	7 ÷ 30	800	200	2,5	DSE8/4609KS	DSE8/4619KS
B-4	•	-	30	-	-	30	4	M12 x 1	7 ÷ 30	800	200	4	DSE12/4609KS	DSE12/4619KS
B-4	•	7	23	-	-	30	4	M12 x 1	7 ÷ 30	600	200	6	DSE12/5609KS	DSE12/5619KS
B-5	•	-	35	-	-	35	5	M18 x 1	7 ÷ 40	300	200	10	DSE18/4609KS	DSE18/4619KS
B-5	•	10	25	-	-	35	5	M18 x 1	7 ÷ 40	200	200	14	DSE18/5609KS	DSE18/5619KS
B-5	•	-	35	-	-	35	6	M30 x 1,5	7 ÷ 40	100	200	20	DSE30/4609KS	DSE30/4619KS
B-5	•	15	20	-	-	35	6	M30 x 1,5	7 ÷ 40	100	200	28	DSE30/5609KS	DSE30/5619KS

(*) Note: See mounting precautions (pag. 22)

NPN (negative switching)
Use the above mentioned part number changing the last number 9 with 8 (ie. DSE6,5/4608LKS)

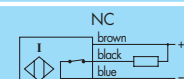
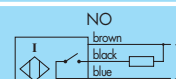

**SHORT SERIES - Extended sensing distance •
Amplified in d.c. •
Connector output M8 x 1 •**

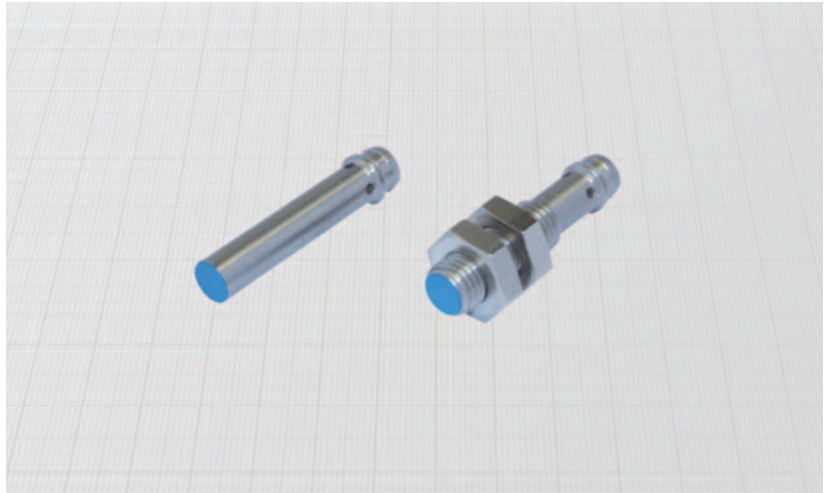
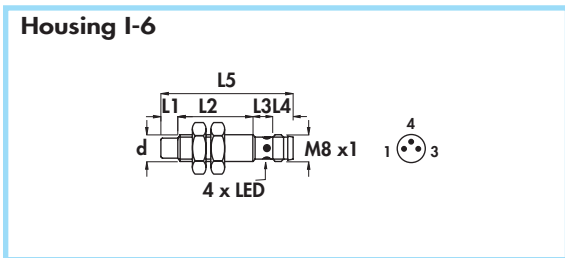
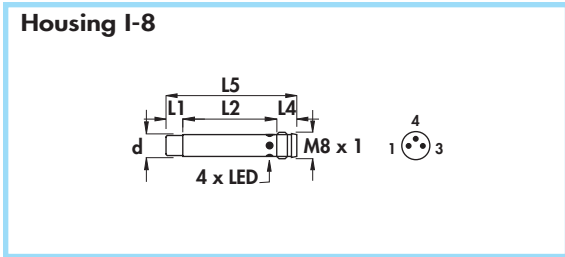

Diameter	M8 x 1	
Nut	Size	SW13
	Thickness mm	4
Max tightening torque Nm	10	

Materials:

- Housing: stainless steel
- Sensing face: plastic

Technical data:

- Supply voltage (U_B): $7 \div 30$ Vdc
- Max ripple: 10%
- No-load supply current (I_0): ≤ 10 mA
- Voltage drop (U_d): $\leq 1,5$ V
- Temperature range: $-20^\circ \div +70^\circ$ C
- Max thermal drift of sensing distance S_r : $\pm 10\%$
- Repeat accuracy (R): 4%
- Switching hysteresis (H): 10%
- Degree of protection: IP67
- Switch status indicator: yellow LED
- Protected against short-circuit and overload
- Protected against any wrong connection
- Suppression of initial false impulse
- Electromagnetic compatibility (EMC) according to EN60947-5-2
- Shock and vibration resistance according to EN60068-2-27 EN60068-2-6

Housing	Flush mounting (*) Non flush mounting	L1	L2	L3	L4	L5	Female connector	Body diameter (d)	Max switching frequency (f)	Rated operational current (I _e)	Nominal sensing distance (S _n) ±10%	ORDERING REFERENCES	
												PNP (positive switching)	
I-8	•	-	29,5	-	5,5	35	11 - 12	6,5	800	200	2,5	 DSE6,5/4909LKS	 DSE6,5/4919LKS
I-6	•	-	21	8,5	5,5	35	11 - 12	M8 x 1	800	200	2,5	 DSE8/4909KS	 DSE8/4919KS

(*) Note: See mounting precautions (pag. 22)

NPN (negative switching)
Use the above mentioned part number changing the last number 9 with 8 (ie. DSE6,5/4908LKS)

--	--

CYLINDRICAL INDUCTIVE SENSORS IN METAL HOUSING

- **SHORT SERIES - Extended sensing distance**
- **Amplified in d.c.**
- Connector output M12 x 1

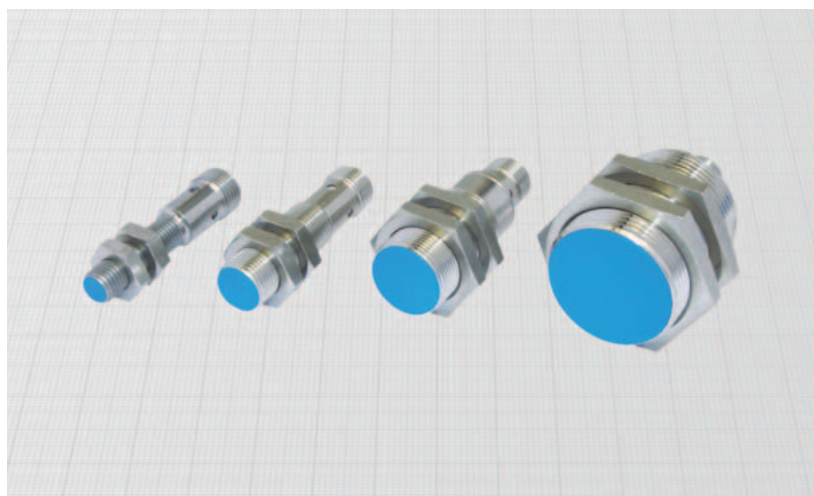
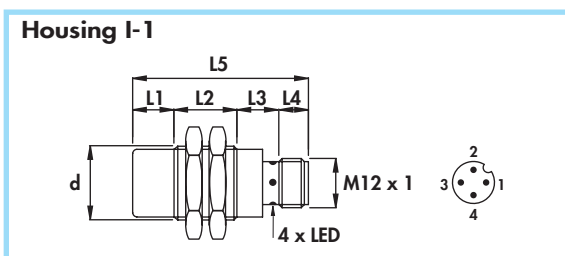
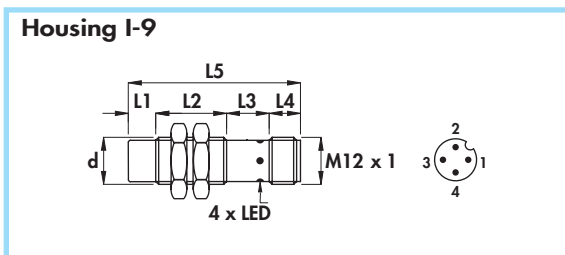
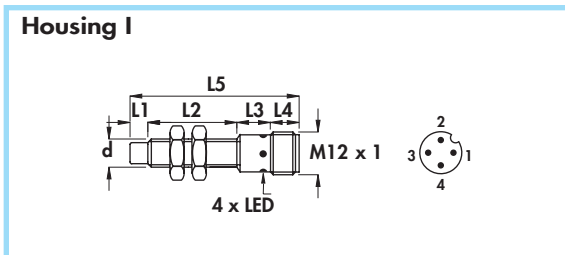

Diameter	M8 x 1	M12 x 1	M18 x 1	M30 x 1,5
Nut	Size	SW13	SW17	SW24
	Thickness mm	4	4	4
Max tightening torque Nm	10	15	35	80

Materials:

- Housing 8 mm: stainless steel
- Housing 12 ÷ 30 mm: nickel plated brass
- Sensing face: plastic

Technical data:

- Supply voltage (U_B): see ordering references
- Max ripple: 10%
- Rated operational current (I_o): 200 mA
- No-load supply current (I_o): ≤ 10 mA
- Voltage drop (U_d): $\leq 1,5$ V
- Temperature range: $-20^\circ \div +70^\circ\text{C}$
- Max thermal drift of sensing distance S_T : $\pm 10\%$
- Repeat accuracy (R): 4%
- Switching hysteresis (H): 10%
- Degree of protection: IP67
- Switch status indicator: yellow LED
- Protected against short-circuit and overload
- Protected against any wrong connection
- Suppression of initial false impulse
- Electromagnetic compatibility (EMC) according to EN60947-5-2
- Shock and vibration resistance according to EN60068-2-27 EN60068-2-6

Housing	Flush mounting (*) Non flush mounting	L1	L2	L3	L4	L5	Female connector	Body diameter (d)	Supply voltage (U_B)	Max switching frequency (f)	Nominal sensing distance (S_n) $\pm 10\%$	ORDERING REFERENCES	
												PNP (positive switching)	
												NO	NC
I	•	-	26	13	8	47	6-8B-10	M8 x 1	7 ÷ 30	800	2,5		
I-9	•	-	30	10	8	48	6-8B-10	M12 x 1	7 ÷ 30	800	4	DSE8/4309KS	DSE8/43C9KS
I-9	•	7	23	10	8	48	6-8B-10	M12 x 1	7 ÷ 30	600	6	DSE12/4309KS DSE12/5309KS	DSE12/43C9KS DSE12/53C9KS
I-1	•	-	30	19	8	57	6-8B-10	M18 x 1	7 ÷ 40	300	10	DSE18/4309KS	DSE18/43C9KS
I-1	•	10	25	15	8	58	6-8B-10	M18 x 1	7 ÷ 40	200	14	DSE18/5309KS	DSE18/53C9KS
I-1	•	-	25	17	8	50	6-8B-10	M30 x 1,5	7 ÷ 40	100	20	DSE30/4309KS	DSE30/43C9KS
I-1	•	15	25	17	8	65	6-8B-10	M30 x 1,5	7 ÷ 40	100	28	DSE30/5309KS	DSE30/53C9KS

(*) Note: See mounting precautions (pag. 22)

NPN (negative switching)
Use the above mentioned part number changing the last number 9 with 8 (ie. DSE8/4308KS)



With extended temperature range (- 40° ÷ + 85°C) •
 Amplified in d.c. 3 and 4 wires •
 Cable output •

Housing A-3

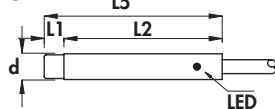

Housing B-6

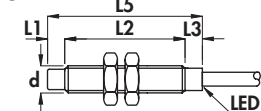

Housing B-3

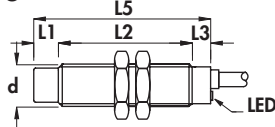

Housing G

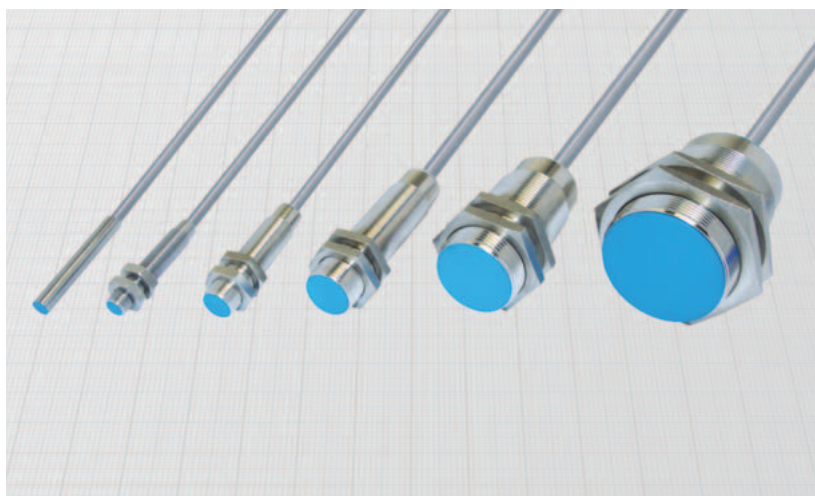
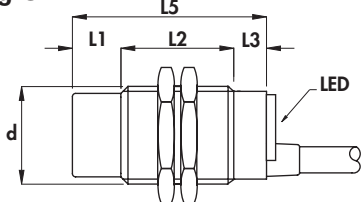

Diameter		M8 x 1	M12 x 1	M18 x 1	M30 x 1,5	M45 x 1,5
Nut	Size	SW13	SW17	SW24	SW36	SW55
	Thkns mm	4	4	4	5	5
Max tightening torque Nm		10	15	35	80	70

Materials:

- Cable: 2 m thermoplastic 140°C; 300 V; O.R.
- Housing 6,5 and 8 mm: stainless steel
- Housing 12 ÷ 45 mm: nickel plated brass
- Sensing face: plastic

Technical data:

- Supply voltage (U_B): 10 ÷ 30 Vdc
- Max ripple: 10%
- No-load supply current (I₀): ≤ 10 mA
- Voltage drop (U_d): see ordering references
- Temperature range: - 40° ÷ + 85°C
- Max thermal drift of sensing distance S_r: ± 10%
- Repeat accuracy (R): 2%
- Switching hysteresis (H): 10%
- Degree of protection: IP67
- Switch status indicator: yellow LED
- Cable conductor cross section: 0,35 mm² on 6,5 - 8 - 12 mm
0,50 mm² on 18, 30 and 45 mm
- Protected against short-circuit and overload
- Protected against any wrong connection
- Suppression of initial false impulse
- Electromagnetic compatibility (EMC) according to EN60947-5-2
- Shock and vibration resistance according to EN60068-2-27 EN60068-2-6

Housing	Flush mounting Non flush mounting	L2	L3	L5	Cable diameter	Body diameter (d)	Voltage drop (U _d)	Max switching frequency (f)	Rated operational current (I _e)	Nominal sensing distance (S _n) ± 10%	ORDERING REFERENCES			
											PNP (positive switching)			
		mm	mm	mm	mm	mm	V	KHz	mA	mm	NO	NC	NO + NC	
A-3	•	45	-	45	4	6,5	1,5	4	150	1,5				
B-6	•	40	5	45	4	M8 x 1	1,5	4	150	1,5				
B-3	•	43	7	50	4	M12 x 1	1,5	2	150	2				
B-3	•	58	12	70	5	M18 x 1	2,2	1	250	5				
G	•	50	10	60	6	M30 x 1,5	2,2	0,8	250	10				
G	•	50	10	60	6	M45 x 1,5	2,2	0,15	250	20				
												NPN (negative switching)		
Use the above mentioned part number changing the last number 9 with 8 (ie. DCA6,5/4608LKST)														
		mm	mm	mm	mm	mm	V	KHz	mA	mm	NO	NC	NO + NC	

CYLINDRICAL INDUCTIVE SENSORS IN METAL HOUSING

- With extended temperature range (-40° ÷ + 85°C)
- Amplified in d.c. 3 and 4 wires
- Connector output M12 x 1

Housing I-16

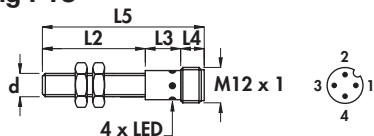

Housing I-17

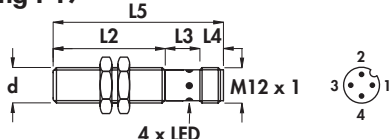

Housing I-18

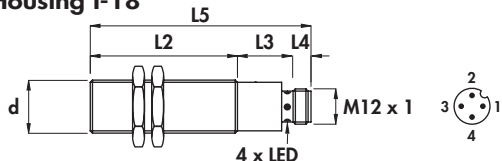

Housing I-19

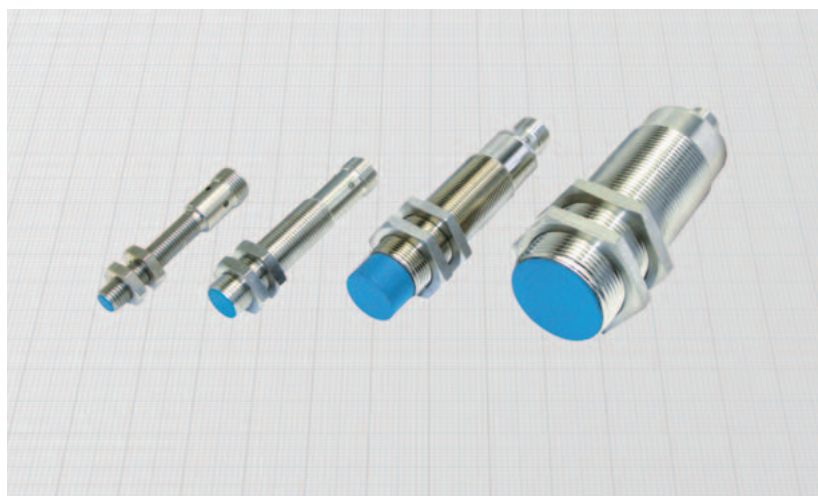
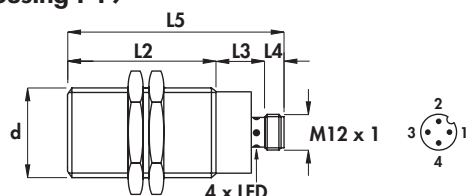

Diameter	M8 x 1	M12 x 1	M18 x 1	M30 x 1,5	M45 x 1,5
Nut	Size SW13	SW17	SW24	SW36	SW55
	Thkns mm 4	4	4	5	5
Max tightening torque Nm	10	15	35	80	70

Materials:

- Housing 8 mm: stainless steel
- Housing 12 ÷ 45 mm: nickel plated brass
- Sensing face: plastic

Technical data:

- Supply voltage (U_B): 10 ÷ 30 Vdc
- Max ripple: 10%
- No-load supply current (I_0): ≤ 10 mA
- Voltage drop (U_d): see ordering references
- Temperature range: -40° ÷ + 85°C
- Max thermal drift of sensing distance S_s : ± 10%
- Repeat accuracy (R): 2%
- Switching hysteresis (H): 10%
- Degree of protection: IP67
- Switch status indicator: yellow LED
- Protected against short-circuit and overload
- Protected against any wrong connection
- Suppression of initial false impulse
- Electromagnetic compatibility (EMC) according to EN60947-5-2
- Shock and vibration resistance according to EN60068-2-27 EN60068-2-6

Housing	Flush mounting Non flush mounting	L2	L3	L4	L5	Female connector (see pag. H-1)	Body diameter (d)	Voltage drop (U_d)	Max switching frequency (f)	Rated operational current (I_o)	Nominal sensing dist. (S_s) ± 10%	ORDERING REFERENCES		
												PNP (positive switching)		
		mm	mm	mm	mm	n°	mm	V	KHz	mA	mm	NO	NC	NO + NC
I-16	•	40	12	8	60	8B-10...T	M8 x 1	1,5	4	150	1,5			
I-17	•	43	15	8	66	8B-10...T	M12 x 1	1,5	2	150	2	DCA8/4309KST	DCA8/43C9KST	-
I-17	•	43	15	8	66	8B-10...T	M12 x 1	1,5	2	150	2	DCA12/4309KST	DCA12/43C9KST	DCA12/4329KST
I-18	•	50	19	8	77	8B-10...T	M18 x 1	2,2	1	250	5	DCA18/4309KST	DCA18/43C9KST	DCA18/4329KST
I-19	•	65	17	8	90	8B-10...T	M30 x 1,5	2,2	0,8	250	10	DCA30/4309KST	DCA30/43C9KST	DCA30/4329KST
I-19	•	50	19	8	77	8B-10...T	M45 x 1,5	2,2	0,15	250	20	DCA45/4309KST	DCA45/43C9KST	DCA45/4329KST

NPN (negative switching)

Use the above mentioned part number changing the last number 9 with 8 (ie. DCA8/4308KST)

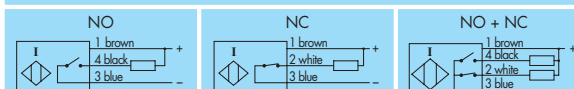

For high temperatures (-25° ÷ +125°C) •
 Amplified in d.c. 3 and 4 wires •
 Cable output •

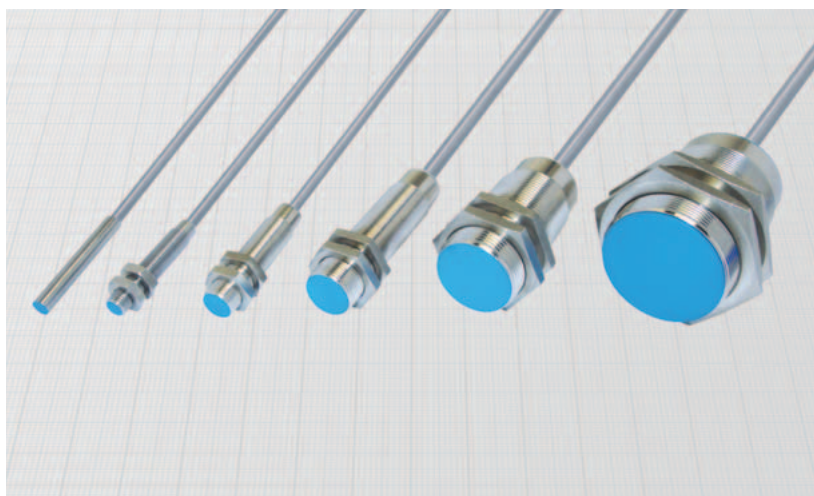
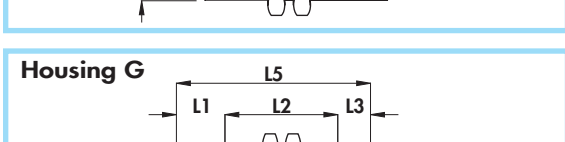
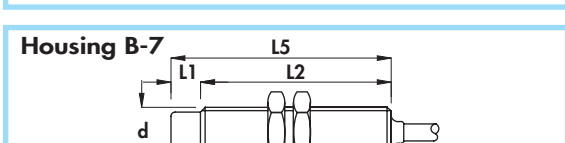
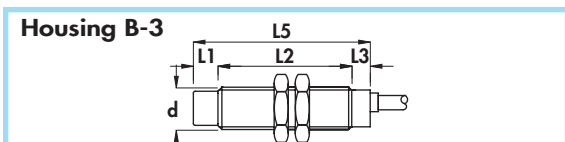
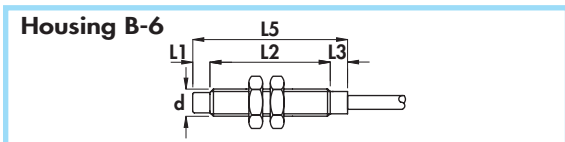
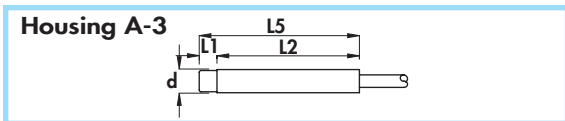

Diameter		M8 x 1	M12 x 1	M18 x 1	M30 x 1,5	M45 x 1,5
Nut	Size	SW13	SW17	SW24	SW36	SW55
	Thickness mm	4	4	4	5	5
Max tightening torque Nm		10	15	35	80	70

Materials:

- Cable: 2 m thermoplastic 140°C; 300 V; O.R.
- Housing 6,5 and 8 mm: stainless steel
- Housing 12 ÷ 45 mm: nickel plated brass
- Sensing face: plastic

Technical data:

- Supply voltage (U_B): 10 ÷ 30 Vdc
- Max ripple: 10%
- No-load supply current (I_0): ≤ 10 mA
- Voltage drop (U_d): see ordering references
- Temperature range: -25° ÷ +125°C
- Max thermal drift of sensing distance S_r : ± 10%
- Repeat accuracy (R): 2%
- Switching hysteresis (H): 10%
- Degree of protection: IP67
- Cable conductor cross section: 0,35 mm² on 6,5 - 8 - 12 mm
0,50 mm² on 18 - 30 - 45 mm

- Protected against short-circuit and overload
- Protected against any wrong connection
- Suppression of initial false impulse
- Electromagnetic compatibility (EMC) according to EN60947-5-2
- Shock and vibration resistance according to EN60068-2-27 EN60068-2-6

Housing	Flush mounting Non flush mounting	L2	L3	L5	Cable diameter	Body diameter (d)	Voltage drop (U_d)	Max switching frequency (f)	Rated operational current (I_e)	Nominal sensing distance (S_n) ± 10%	ORDERING REFERENCES		
											PNP (positive switching)		
		mm	mm	mm	mm	mm	V	KHz	mA	mm			
A-3	•	45	-	45	4	6,5	1,5	4	150	1,5	DCA6,5/4609LKT	DCA6,5/4619LKT	-
B-6	•	40	5	45	4	M8 x 1	1,5	4	150	1,5	DCA8/4609KT	DCA8/4619KT	-
B-3	•	43	7	50	4	M12 x 1	1,5	2	150	2	DCA12/4609KT	DCA12/4619KT	-
B-7	•	65	-	65	5	M18 x 1	2,2	1	250	5	DCA18/4609KT	DCA18/4619KT	DCA18/4629KT
G	•	50	10	60	6	M30 x 1,5	2,2	0,8	250	10	DCA30/4609KT	DCA30/4619KT	DCA30/4629KT
G	•	50	10	60	6	M45 x 1,5	2,2	0,15	250	20	DCA45/4609KT	DCA45/4619KT	DCA45/4629KT

NPN (negative switching)

Use the above mentioned part number changing the last number 9 with 8 (ie. DCA6,5/4608LKT)

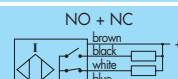
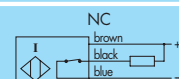
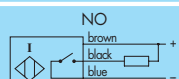

CYLINDRICAL INDUCTIVE SENSORS IN METAL HOUSING

- For high temperatures (-25° ÷ + 120°C)
- Amplified in d.c. 3 and 4 wires
- Connector output M12 x 1

Housing I-16

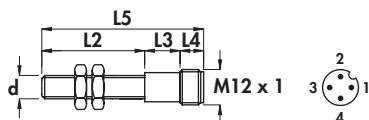

Housing I-17

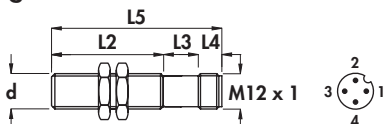

Housing I-18

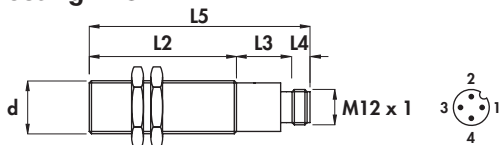

Housing I-19

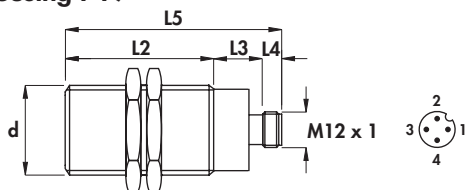

Diameter		M8 x 1	M12 x 1	M18 x 1	M30 x 1,5
Nut	Size	SW13	SW17	SW24	SW36
	Thickness mm	4	4	4	5
Max tightening torque Nm		10	15	35	80

Materials:

- Housing 8 mm: stainless steel
- Housing 12 ÷ 30 mm: nickel plated brass
- Sensing face: plastic

Technical data:

- Supply voltage (U_b): 10 ÷ 30 Vdc
- Max ripple: 10%
- No-load supply current (I_o): ≤ 10 mA
- Voltage drop (U_d): see ordering references
- Temperature range: -25° ÷ +120° C
- Max thermal drift of sensing distance S_T : ± 10%
- Repeat accuracy (R): 2%
- Switching hysteresis (H): 10%
- Degree of protection: IP67
- Protected against short-circuit and overload
- Protected against any wrong connection
- Suppression of initial false impulse
- Electromagnetic compatibility (EMC) according to EN60947-5-2
- Shock and vibration resistance according to EN60068-2-27 EN60068-2-6

Housing	Flush mounting Non flush mounting	L2	L3	L4	L5	Female connector (see pag. H-1)	Body diameter (d)	Voltage drop (U_d)	Max switching frequency (f)	Rated operational current (I_o)	Nominal sensing dist. (S_T) ± 10%	ORDERING REFERENCES		
												PNP (positive switching)		
		mm	mm	mm	mm	n°	mm	V	KHz	mA	mm	NO	NC	NO + NC
I-11	•	40	12	8	60	8B-10...T	M8 x 1	1,5	4	150	1,5			-
I-7	•	43	15	8	66	8B-10...T	M12 x 1	1,5	2	150	2			
I-12	•	50	19	8	77	8B-10...T	M18 x 1	2,2	1	250	5			
I-2	•	65	17	8	90	8B-10...T	M30 x 1,5	2,2	0,8	250	10			
I-2	•	50	19	8	77	8B-10...T	M45 x 1,5	2,2	0,15	250	20			

NPN (negative switching)

Use the above mentioned part number changing the last number 9 with 8 (ie. DCA8/4308KT)

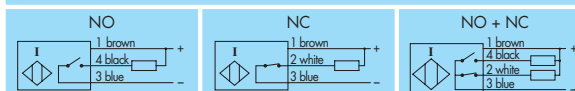

- Degree of protection IP68 •
- Amplified in d.c. 3 and 4 wires •
- Cable and connector output M12 x 1 •

Housing J-1

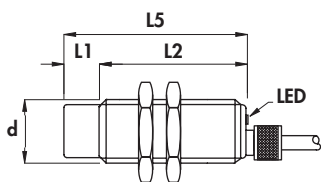

Housing J-2

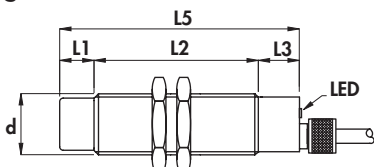

Housing I-12

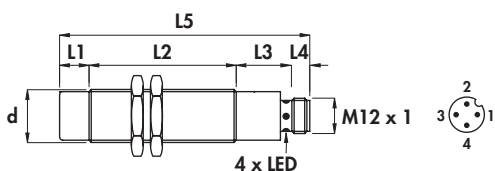

Diameter	M18 x 1	
Nut	Size	SW24
	Thickness mm	4
Max tightening torque Nm	35	

Materials:

- Cable: 2 m PVC CEI 20 - 22 II; 90°C; 300 V; O.R.
- Housing and gland: nickel plated brass
- Sensing face: plastic

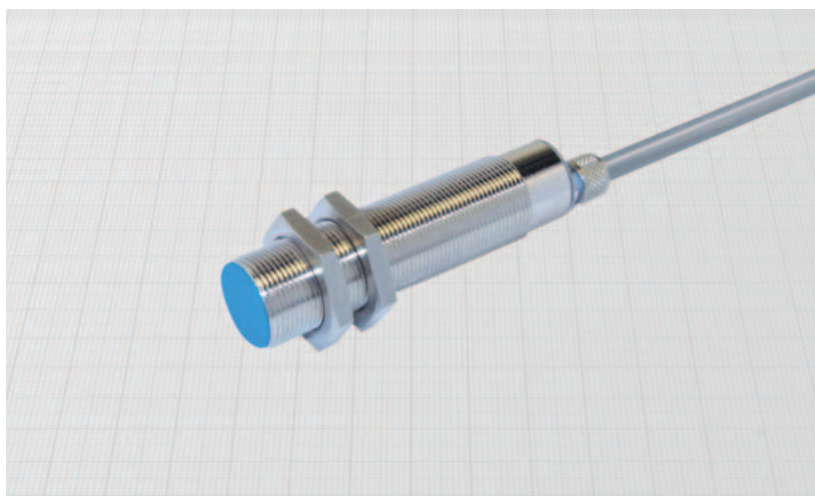

General Features:

This new series solves definitively the problem of the ingress of liquids to the inner parts of the sensors. Thanks to the inner hermetic sealing they can be submitted to no-stop jets of liquids under pressure even in presence of temperature changes. They find application in automatic washing machinery, in machines subject to water jets and in continuous immersion applications.

Technical data:

- Supply voltage (U_b): 7 ÷ 60 Vdc
- Max ripple: 10%
- Rated operational current (I_o): 400 mA
- No-load supply current (I_d): ≤ 10 mA
- Voltage drop (U_d): ≤ 2,2 V
- Temperature range: -25° ÷ +75°C
- Max thermal drift of sensing distance S_r : ± 10%
- Repeat accuracy (R): 2%
- Switching hysteresis (H): 10%
- Degree of protection: IP68
- Switch status indicator: yellow LED
- Cable conductor cross section: 0,50 mm²
- Protected against short-circuit and overload
- Protected against any wrong connection
- Suppression of initial false impulse
- Electromagnetic compatibility (EMC) according to EN60947-5-2
- Shock and vibration resistance according to EN60068-2-27 EN60068-2-6

Housing	Flush mounting Non flush mounting	L1	L2	L3	L4	L5	Cable diameter	Female connector	Body diameter (d)	Max switching frequency (f)	Nominal sensing distance (S_n) ± 10%	ORDERING REFERENCES		
												PNP (positive switching)		
												NO	NC	NO + NC
J-1	•	-	50	-	-	50	5	-	M18 x 1	1	5	DCA18/4A09KSJ	DCA18/4A19KSJ	-
J-1	•	10	40	-	-	50	5	-	M18 x 1	1	8	DCA18/5A09KSJ	DCA18/5A19KSJ	-
J-2	•	-	58	12	-	70	5	-	M18 x 1	1	5	DCA18/4609KSJ	DCA18/4619KSJ	DCA18/4629KSJ
J-2	•	10	48	12	-	70	5	-	M18 x 1	1	8	DCA18/5609KSJ	DCA18/5619KSJ	DCA18/5629KSJ
I-12	•	-	50	19	8	77	-	6-8B-10	M18 x 1	1	5	DCA18/4309KSJ	DCA18/43C9KSJ	DCA18/4329KSJ
I-12	•	10	50	19	8	87	-	6-8B-10	M18 x 1	1	8	DCA18/5309KSJ	DCA18/53C9KSJ	DCA18/5329KSJ
												NPN (negative switching)		
												Use the above mentioned part number changing the last number 9 with 8 (ie. DCA18/4A08KSJ)		
			NO	NC	NO + NC									
			(*) Note: In versions with connector use the white wire.											

CYLINDRICAL INDUCTIVE SENSORS IN METAL HOUSING

- **SHORT SERIES - degree of protection IP68**
- **Amplified in d.c. 3 wires**
- Cable and connector output M12 x 1

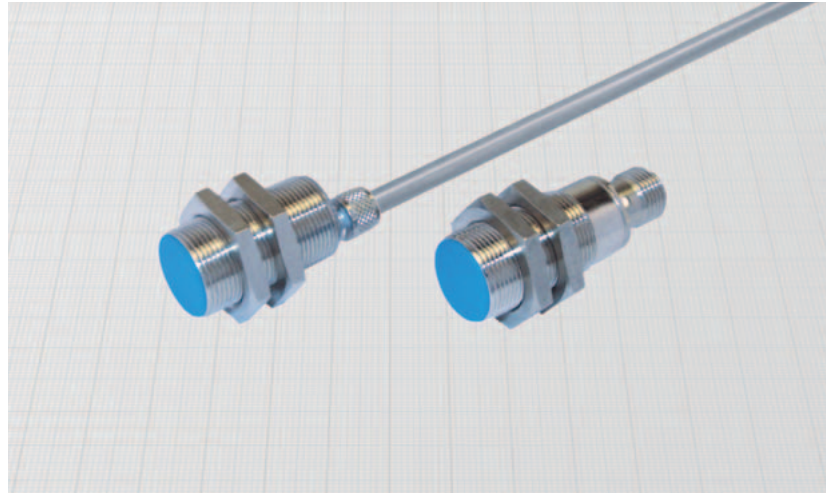
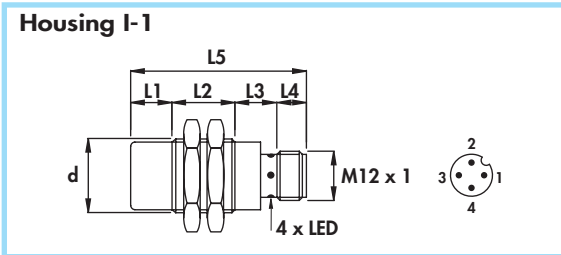
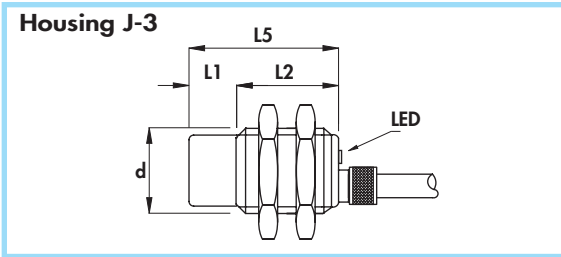

Diameter	M18 x 1	
Nut	Size	SW24
	Thickness mm	4
Max tightening torque Nm	35	

Materials:

- Cable: 2 m PVC CEI 20 - 22 II; 90°C; 300 V; O.R.
- Housing and gland: nickel plated brass
- Sensing face: plastic

General Features:

This new series solves definitively the problem of the ingress of liquids to the inner parts of the sensors. Thanks to the inner hermetic sealing they can be submitted to no-stop jets of liquids under pressure even in presence of temperature changes. They find application in automatic washing machinery, in machines subject to water jets and in continuous immersion applications.

Technical data:

- Supply voltage (U_b): 5 ÷ 40 Vdc
- Max ripple: 10%
- No-load supply current (I_o): ≤ 10 mA
- Voltage drop (U_d): ≤ 1,5 V
- Temperature range: -25° ÷ +70°C
- Max thermal drift of sensing distance S_T : ± 10%
- Repeat accuracy (R): 2%
- Switching hysteresis (H): 10%
- Degree of protection: IP68
- Switch status indicator: yellow LED
- Cable conductor cross section: 0,50 mm²
- Protected against short-circuit and overload
- Protected against any wrong connection
- Suppression of initial false impulse
- Electromagnetic compatibility (EMC) according to EN60947-5-2
- Shock and vibration resistance according to EN60068-2-27 EN60068-2-6

Housing	Flush mounting Non flush mounting	L1	L2	L3	L4	L5	Cable diameter	Female connector	Body diameter (d)	Max switching frequency (f)	Rated operational current (I _e)	Nominal sensing distance (S _n) ± 10%	ORDERING REFERENCES	
													PNP (positive switching)	
J-3	•	-	30	-	-	30	5	-	M18 x 1	0,8	200	5		
J-3	•	10	20	-	-	30	5	-	M18 x 1	0,6	200	8	DSA18/4609KSJ DSA18/5609KSJ	DSA18/4619KSJ DSA18/5619KSJ
I-1	•	-	25	15	8	48	-	6-8B-10	M18 x 1	0,8	200	5		
I-1	•	10	15	15	8	48	-	6-8B-10	M18 x 1	0,6	200	8		
													NPN (negative switching)	
													Use the above mentioned part number changing the last number 9 with 8 (ie. DSA18/4608KSJ)	

Non polarized •
 Amplified in d.c. 2 wires •
 Cable output •

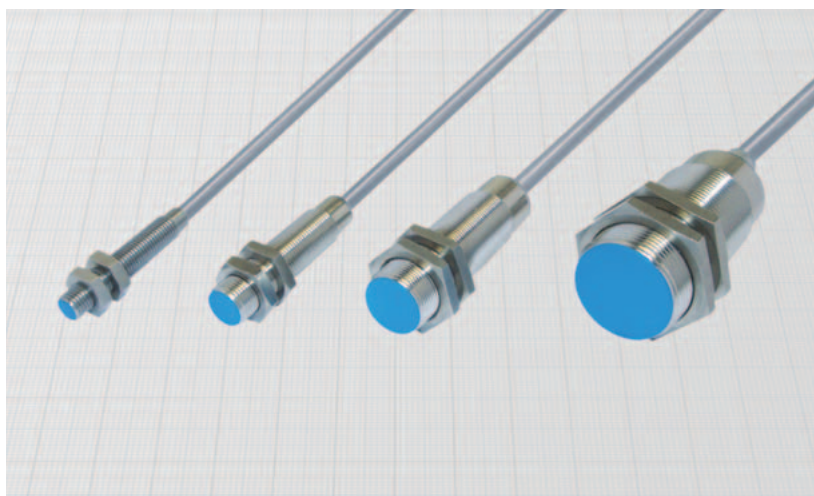
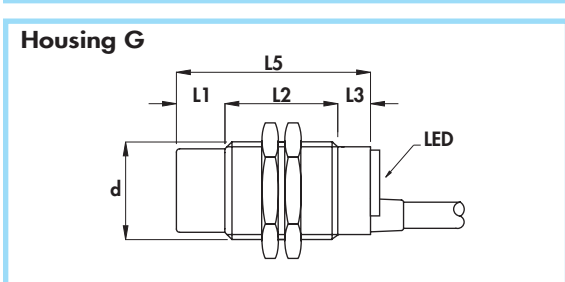
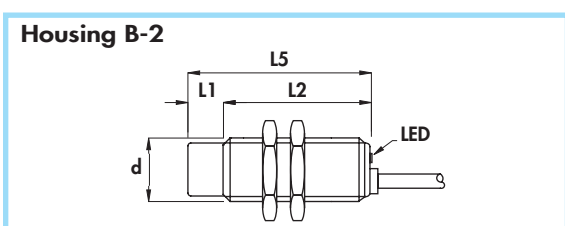
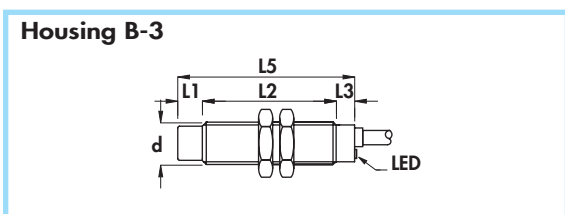
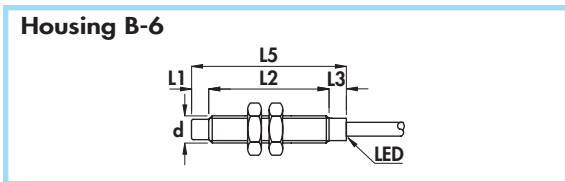

Diameter		M8 x 1	M12 x 1	M18 x 1	M30 x 1,5
Nut	Size	SW13	SW17	SW24	SW36
	Thickness mm	4	4	4	5
Max tightening torque Nm		10	15	35	80

Materials:

- Cable: 2 m PVC CEI 20 - 22 II; 90°C; 300 V; O.R.
- Housing 8 mm: stainless steel
- Housing 12-18-30 mm: nickel plated brass
- Sensing face: plastic PBT

General Features:

These sensors are not polarized and the load can be connected on both positive and negative lead (function PNP or NPN). So they can replace traditional mechanical microswitches in many applications.

Technical data:

- Supply voltage (U_B): 10 ÷ 55 Vdc
- Max ripple: 10%
- Off-state current (I_o): ≤ 1 mA
- Minimum operational current (I_m): 5 mA
- Voltage drop (U_d) with $I_e = 10$ mA: ≤ 5 V
- Voltage drop (U_d) with $I_e = 100$ mA: ≤ 6 V
- Temperature range: -25° ÷ +70°C
- Max thermal drift of sensing distance S_s : ± 10%
- Repeat accuracy (R): 2%
- Switching hysteresis (H): 10%
- Degree of protection: IP67
- Switch status indicator: yellow LED
- Cable conductor cross section: 0,34 mm² on 8 and 12 mm
0,50 mm² on 18 mm
0,75 mm² on 30 mm
- Protected against short-circuit and overload (versions with letter K)
- Suppression of initial false impulse
- Electromagnetic compatibility (EMC) according to EN60947-5-2
- Shock and vibration resistance according to EN60068-2-27 EN60068-2-6

Housing	Flush mounting Non flush mounting	L1	L2	L3	L4	L5	Cable diameter	Body diameter (d)	Nominal sensing distance (S_n) ± 10%	Max switching frequency (f)	Rated operational current (I_e)	ORDERING REFERENCES	
		mm	mm	mm	mm	mm						mm	mm
B-6	•	-	40	5	-	45	4	M8 x 1	1,5	1200	100	DCM8/4600S	DCM8/4610S
B-6	•	5	35	5	-	45	4	M8 x 1	2,5	1000	100	DCM8/5600S	DCM8/5610S
B-3	•	-	43	7	-	50	4	M12 x 1	2	1200	200	DCM12/4600KS	DCM12/4610KS
B-3	•	7	36	7	-	50	4	M12 x 1	4	1000	200	DCM12/5600KS	DCM12/5610KS
B-2	•	-	50	-	-	50	5	M18 x 1	5	1100	250	DCM18/4A00KS	DCM18/4A10KS
B-2	•	10	40	-	-	50	5	M18 x 1	8	700	250	DCM18/5A00KS	DCM18/5A10KS
G	•	-	50	10	-	60	6	M30 x 1,5	10	800	250	DCM30/4600KS	DCM30/4610KS
G	•	15	35	10	-	60	6	M30 x 1,5	15	400	250	DCM30/5600KS	DCM30/5610KS

CYLINDRICAL INDUCTIVE SENSORS IN METAL HOUSING

- Non polarized
- Amplified in d.c. 2 wires
- Connector output

Housing I-11

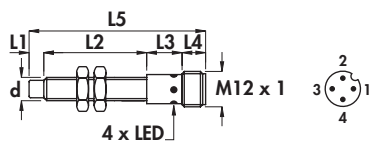

Housing I-7

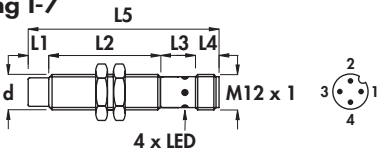

Housing I-12

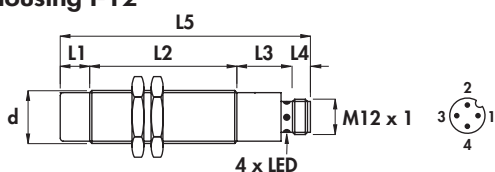

Housing I-2

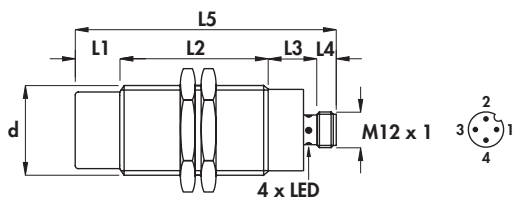

Diameter	M8 x 1	M12 x 1	M18 x 1	M30 x 1,5
Nut	Size SW13	SW17	SW24	SW36
	Thickness mm 4	4	4	5
Max tightening torque Nm	10	15	35	80

Materials:

- Housing 8 mm: stainless steel
- Housing 12- 18 - 30 mm: nickel plated brass
- Sensing face: plastic PBT

General Features:

These sensors are not polarized and the load can be connected on both positive and negative sectors (function PNP or NPN). So they can replace traditional mechanical microswitches in many applications. Utilization of connectors without LED is recommended.

Technical data:

- Supply voltage (U_b): 10 ÷ 55 Vdc
- Max ripple: 10%
- Off-state current (I_o): ≤ 1 mA
- Minimum operational current (I_m): 5 mA
- Voltage drop (U_d) with $I_e = 10$ mA: ≤ 5 V
- Voltage drop (U_d) with $I_e = 100$ mA: ≤ 6 V
- Temperature range: - 25° ÷ + 70°C
- Max thermal drift of sensing distance S_r : ± 10%
- Repeat accuracy (R): 2%
- Switching hysteresis (H): 10%
- Degree of protection: IP67
- Switch status indicator: yellow LED
- Protected against short-circuit and overload (versions with letter K)
- Suppression of initial false impulse
- Electromagnetic compatibility (EMC) according to EN60947-5-2
- Shock and vibration resistance according to EN60068-2-27 EN60068-2-6

Housing	Flush mounting Non flush mounting	L1	L2	L3	L4	L5	Female connector	Body diameter (d)	Nominal sensing distance (S_r) ± 10%	Max switching frequency (f) in d.c.	Rated operational current (I_e)	ORDERING REFERENCES	
												NO (connectors 3 or 4 wires)	NC (connectors 4 wires)
I-11	•	-	40	12	8	60	6-8B-10	M8 x 1	1,5	1200	100	 DCM8/4300S DCM8/5300S	 DCM8/4310S DCM8/5310S
I-11	•	5	35	12	8	60	6-8B-10	M8 x 1	2,5	1000	100		
I-7	•	-	43	15	8	66	6-8B-10	M12 x 1	2	1200	200	 DCM12/4300KS DCM12/5300KS	 DCM12/4310KS DCM12/5310KS
I-7	•	7	36	15	8	66	6-8B-10	M12 x 1	4	1000	200		
I-12	•	-	50	19	8	77	6-8B-10	M18 x 1	5	1100	250	 DCM18/4300KS DCM18/5300KS	 DCM18/4310KS DCM18/5310KS
I-12	•	10	50	19	8	87	6-8B-10	M18 x 1	8	700	250		
I-2	•	-	65	17	8	90	6-8B-10	M30 x 1,5	10	800	250	 DCM30/4300KS DCM30/5300KS	 DCM30/4310KS DCM30/5310KS
I-2	•	15	50	17	8	90	6-8B-10	M30 x 1,5	15	400	250		

Stainless steel sensing face •
Amplified in d.c. 3 wires •
Cable output •

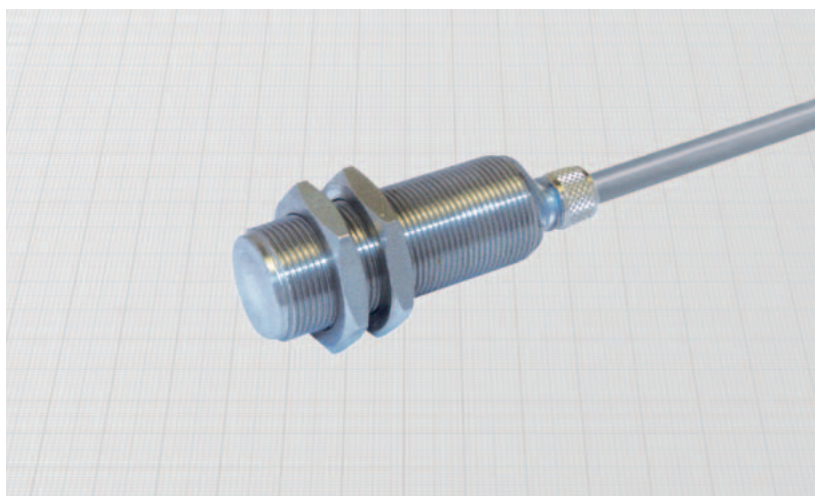
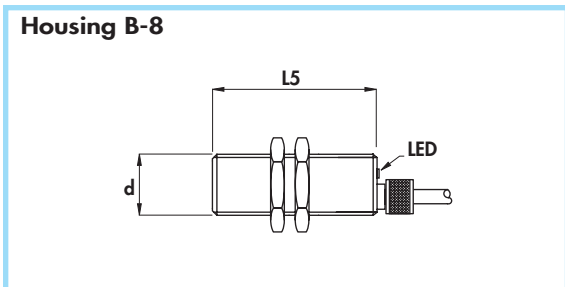

Diameter		M18 x 1
Nut	Size	SW24
	Thickness mm	4
Max tightening torque Nm		35

Materials:

- Cable: 2 m PVC CEI 20 - 22 II; 90°C; 300 V; O.R.
- Housing: stainless steel
- Sensing face: stainless steel

General Features:

This particular type of sensor has increased mechanical and chemical resistance:

- **fluid ingress resistant**
- **pressure resistant**
- **corrosion resistant**
- **impact resistant**
- **vibration resistant**
- **abrasion and incandescent objects resistant**

These particular characteristics are mainly dependent by the building of the body, which is made from a single solid piece of stainless steel. The absence of junctions doesn't allow the fluid ingress through the sensing face. A very special sealing system on the back side makes of this sensor the ideal solution for the most critical applications.

Technical data:

- Supply voltage (U_B): $7 \div 40$ Vdc
- Max ripple: 10%
- No-load supply current (I_0): ≤ 10 mA
- Voltage drop (U_d): $\leq 1,5$ V
- Temperature range: $-25^\circ \div +75^\circ\text{C}$
- Max thermal drift of sensing distance S_r : $\pm 10\%$
- Repeat accuracy (R): 2%
- Switching hysteresis (H): 10%
- Degree of protection: IP68
- Max pressure on the front side: 50 bar
- Switch status indicator: yellow LED
- Cable conductor cross section: $0,50$ mm²
- Protected against short-circuit and overload
- Protected against any wrong connection
- Suppression of initial false impulse
- Electromagnetic compatibility (EMC) according to EN60947-5-2
- Shock and vibration resistance according to EN60068-2-27 EN60068-2-6

Housing	Flush mounting (*) Non flush mounting	L1	L2	L3	L4	L5	Cable diameter	Body diameter (d)	Max switching frequency (f _f)	Rated operational current (I _e)	Nominal sensing distance (S _n) ± 10%	ORDERING REFERENCES	
												PNP (positive switching)	
B-8	•	-	-	-	-	45	5	M18 x 1	50	200	5		
												DCA18/4609MKSJ	DCA18/4619MKSJ

(*) Note: See mounting precautions (pag. 22)

NPN (negative switching)	
Use the above mentioned part number changing the last number 9 with 8 (ie. DCA18/4608MKSJ)	

CYLINDRICAL INDUCTIVE SENSORS IN METAL HOUSING

- Amplified in d.c. 3 wires
- High precision
- Switching hysteresis < 1 μm
- Cable output



General Features:

This unique sensor enables the detection of metallic targets with extremely high precision without contact. By using an implemented software algorithm and a laser working process it has a very stable and precise switching point with a hysteresis lower than 1 μm .

Applications:

- Semiconductors industry
- Quality control instruments
- High precision mechanical devices
- Calibration equipments

Technical data:

- Supply voltage (U_B): $5 \div 13 \text{ Vdc}$
- Consumption: $\leq 10 \text{ mA}$
- Voltage drop ($I_o = 10 \text{ mA}$): $\leq 0.5 \text{ V}$
- Voltage drop ($I_o = 100 \text{ mA}$): $\leq 1 \text{ V}$
- Output polarity: NPN open collector
- Output logic: normally open
- Repeat accuracy (R): $< \pm 2 \mu\text{m}$
- Switch hysteresis (H): $< 1 \mu\text{m}$
- Temperature range: $10 \div 40^\circ\text{C}$
- Degree of protection: IP67
- Cable conductor cross section: $0,22 \text{ mm}^2$
- Electromagnetic compatibility (EMC) according to EN60947-5-2 
- Shock and vibration resistance according to EN60068-2-27 EN60068-2-6

Diameter	M5 x 0,5	
Nut	Size	SW7
	Thickness mm	2,5
Max tightening torque Nm	2	

Materials:

- Cable: 2 m PVC CEI 20 - 22 II; 90°C
- Housing sensor and amplifier: stainless steel

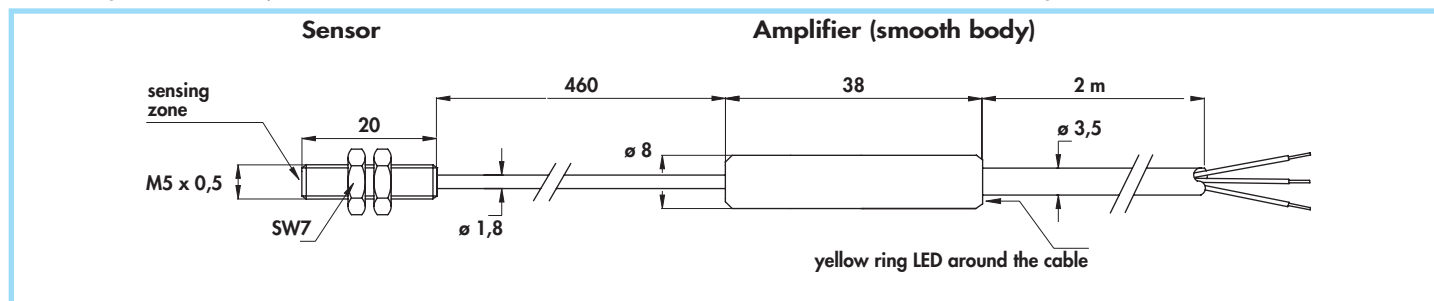

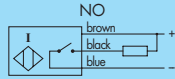
Flush mounting Non flush mounting	Cable diameter	Sensor diameter	Amplifier diameter	Rated operational current (I_o)	Max switching frequency (f)	Nominal sensing distance (S_n) $\pm 10\%$	ORDERING REFERENCES	
							NPN (negative switching)	
	mm	mm	mm	mA	Hz	mm		
•	3,5	M5 x 0,5	8	100	100	0,9	IPS05/4608KS	

- Diameters 12 - 18 mm •
- Analog with linear current output •
- Cable output •

Housing B-3

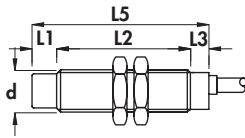

Housing B-2

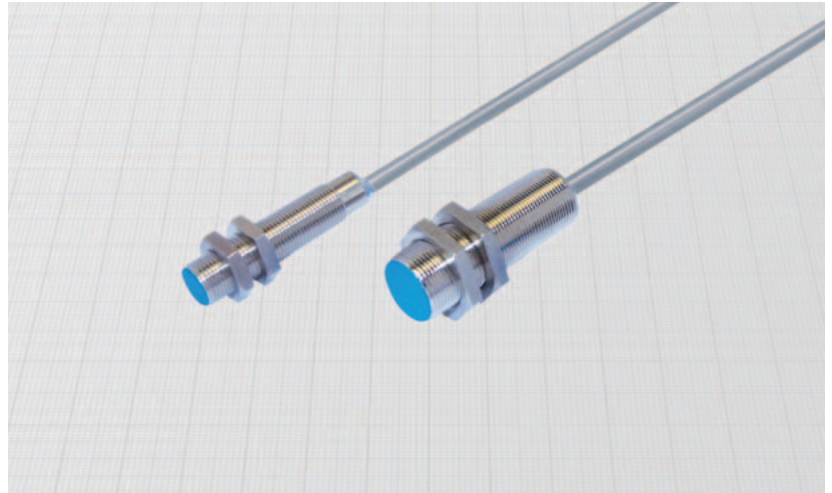
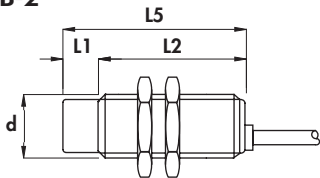

Typical curves

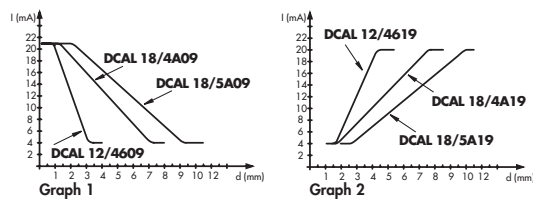

2 wires connection

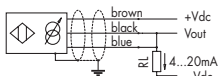

Vout (V)	RL (ohm)	Vdc (min)
0,4 ... 2	100	12
2 ... 10	500	20
4 ... 20	1000	30

$$RL (max) = \frac{(V_{dc}-10) K\Omega}{20}$$

3 wires connection

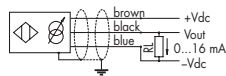

Vout (V)	RL (ohm)	Vdc (min)
0 ... 1	42,5	11
0 ... 10	425	15
0 ... 16	1000	21
0 ... 20	1250	25
0 ... 30	1875	35

$$RL (max) = \frac{(V_{dc}-5) K\Omega}{16}$$

Diameter		M12 x 1	M18 x 1
Nut	Size	SW17	SW24
	Thickness mm	4	4
Max tightening torque Nm		15	35

Materials:

- Cable: 2 m PVC CEI 20 - 22 II; 90°C; 300 V; O.R. shielded
- Housing: nickel plated brass
- Sensing face: plastic

General Features:

These inductive proximity sensors provide an output current directly or reversely proportional to the distance between the sensing face and the metal target. The output current is also dependent by the material of the target, so they can be used not only to detect distances, displacements, vibrations and wavings but also to recognize the composition of metals and alloys. In the two wires configuration, they are reversal polarity and short circuit protected devices compliant to the 4-20 mA industrial standard.

Use of the sensor:

The output current flows through the external load R_L generating a voltage (V_o) used to drive the input stage of the measuring instrument. The correct value of R_L can be chosen accordingly to the values of power supply V_{dc} and the wanted V_{out} range as reported on the tables.

Technical data:

- Supply voltage: 10 ÷ 40 Vdc
- Max ripple: 20%
- Output current range: 0 ÷ 16 mA or 4 ÷ 20 mA
- Temperature range: -10° ÷ +70°C
- Max thermal drift: < 10%
- Degree of protection: IP67
- Cable conductor cross section: 0,22 mm² + shield on 12 mm
0,35 mm² + shield on 18 mm

- Electromagnetic compatibility (EMC) according to EN61000-6-2/-4
- Shock and vibration resistance according to EN60068-2-27 EN60068-2-6

Housing	Flush mounting Non flush mounting	L1	L2	L3	L5	Cable diameter	Body diameter (d)	Linearity error max	No. load supply current	Max switching frequency (F)	Repeat accuracy (R)	Measure range	ORDERING REFERENCES	
		mm	mm	mm	mm								INVERSELY PROPORTIONAL Graph 1	DIRECTLY PROPORTIONAL Graph 2
		mm	mm	mm	mm								mm	mm
B-3	•	-	43	7	50	4	M12 x 1	5	4	250	0,5	1 ÷ 4	DCAL12/4609	DCAL12/4619
D-1	•	-	50	-	50	5	M18 x 1	3	4	250	0,5	2 ÷ 7	DCAL18/4A09	DCAL18/4A19
D-1	•	10	40	-	50	5	M18 x 1	3	4	250	0,5	3 ÷ 9	DCAL18/5A09	DCAL18/5A19

CYLINDRICAL INDUCTIVE SENSORS IN METAL HOUSING

- Diameters 30 - 80 mm
- Analog with linear current output
- Cable output

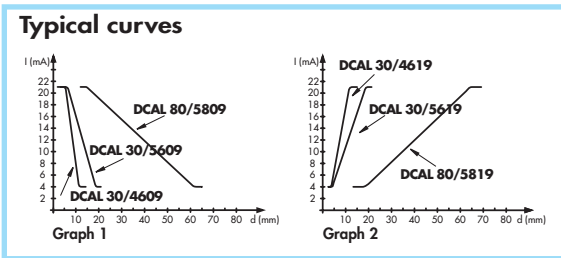
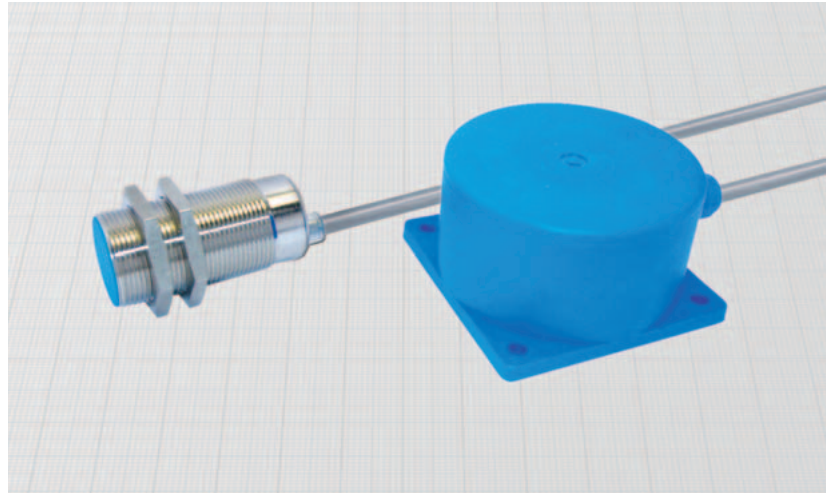
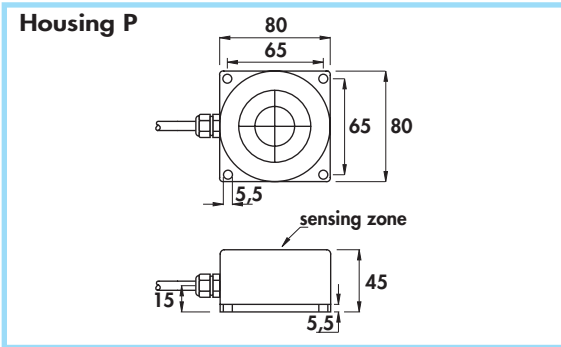
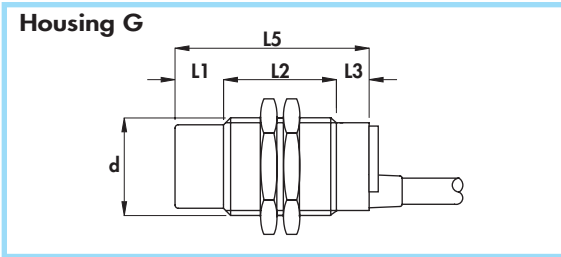

2 wires connection

Vout (V)	RL (ohm)	Vdc (min)
0,4 ... 2	100	15
2 ... 10	500	20
4 ... 20	1000	30

$RL (max) = \frac{(Vdc-10) K\Omega}{20}$

3 wires connection

Vout (V)	RL (ohm)	Vdc (min)
0 ... 1	62,5	11
0 ... 10	625	15
0 ... 16	1000	21
0 ... 20	1250	25
0 ... 30	1875	35

$RL (max) = \frac{(Vdc-5) K\Omega}{16}$

Diameter	M30 x 1,5
Nut	Size
	Thickness mm
Max tightening torque Nm	80

Materials:

- Cable: 2 m PVC CEI 20 - 22 II; 90°C; 300 V; O.R. shielded
- Housing 30 mm: nickel plated brass
- Housing 80 mm: plastic
- Sensing face: plastic

General Features:

These inductive proximity sensors provide an output current directly or reversely proportional to the distance between the sensing face and the metal target. The output current is also dependent by the material of the target, so they can be used not only to detect distances, displacements, vibrations and wavings but also to recognize the composition of metals and alloys. In the two wires configuration, they are reversal polarity and short circuit protected devices compliant to the 4-20 mA industrial standard.

Use of the sensor:

The output current flows through the external load RL generating a voltage (V_o) used to drive the input stage of the measuring instrument. The correct value of RL can be choosed accordingly to the values of power supply Vdc and the wanted Vout range as reported on the tables.

Technical data:

- Supply voltage: 10 ÷ 40 Vdc
- Max ripple: 20%
- Output current range: 0 ÷ 16 mA or 4 ÷ 20 mA
- Temperature range: - 10° ÷ + 70°C
- Max thermal drift: < 10%
- Degree of protection: IP67
- Electromagnetic compatibility (EMC) according to EN61000-6-2/-4
- Shock and vibration resistance according to EN60068-2-27 EN60068-2-6

Housing	Flush mounting Non flush mounting	L1	L2	L3	L4	L5	Cable diameter	Body diameter (d)	Max switching frequency (f)	Repeat accuracy (R)	Maximum linearity error	No-load supply current	Measure range	ORDERING REFERENCES	
		mm	mm	mm	mm	mm								INVERSELY PROPORTIONAL Graph 1	DIRECTLY PROPORTIONAL Graph 2
G	•	-	50	10	-	60	5	M30 x 1,5	250	0,5	5	4	4 ÷ 12	DCAL30/4609	DCAL30/4619
G	•	15	35	10	-	60	5	M30 x 1,5	250	0,5	5	4	5 ÷ 18	DCAL30/5609	DCAL30/5619
P	•	-	-	-	-	-	5	80	250	0,5	5	4	20 ÷ 60	DCAL80/5809	DCAL80/5819

Diameters 12 - 18 mm •
 Analog with linear current output •
 Connector output M12 x 1 •

Housing A-7

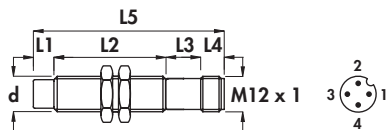

Housing I-12

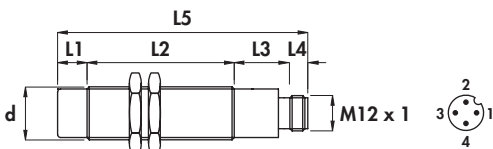

Typical curves

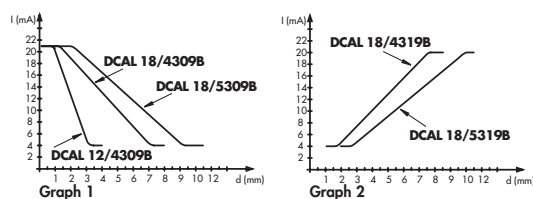

2 wires connection

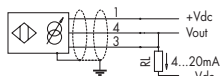

Vout (V)	RL (ohm)	Vdc (min)
0,4 ... 2	100	15
2 ... 10	500	20
4 ... 20	1000	30

$RL (max) = \frac{[Vdc-10] \cdot K\Omega}{20}$

3 wires connection

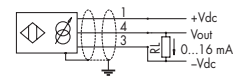

Vout (V)	RL (ohm)	Vdc (min)
0 ... 1	625	11
0 ... 10	625	15
0 ... 16	1000	21
0 ... 20	1250	25
0 ... 30	1875	35

$RL (max) = \frac{[Vdc-5] \cdot K\Omega}{16}$

General Features:

These inductive proximity sensors provide an output current directly or reversely proportional to the distance between the sensing face and the metal target. The output current is also dependent by the material of the target, so they can be used not only to detect distances, displacements, vibrations and wavings but also to recognize the composition of metals and alloys. In the two wires configuration, they are reversal polarity and short circuit protected devices compliant to the 4-20 mA industrial standard.

It is recommended the use of connectors without LED.

For applications subjected to high levels of electromagnetic interferences, it is recommended the use of the straight connector with shielded cable type C10/00...VS which offers a 360° shielding.

Use of the sensor:

The output current flows through the external load RL generating a voltage (V_o) used to drive the input stage of the measuring instrument. The correct value of RL can be choosed accordingly to the values of power supply Vdc and the wanted Vout range as reported on the tables.

Materials:

- Housing: nickel plated brass
- Sensing face: plastic

Technical data:

- Supply voltage: 10 ÷ 40 Vdc
- Max ripple: 20%
- Output current range: 0 ÷ 16 mA or 4 ÷ 20 mA
- Temperature range: - 10° ÷ + 70°C
- Max thermal drift: < 10%
- Degree of protection: IP67
- Electromagnetic compatibility (EMC) according to EN61000-6-2/-4
- Shock and vibration resistance according to EN60068-2-27 EN60068-2-6

Diameter		M12 x 1	M18 x 1
Nut	Size	SW17	SW24
	Thickness mm	4	4
Max tightening torque Nm		15	35

Housing	Flush mounting Non flush mounting	L1	L2	L3	L4	L5	Female connector	Body diameter (d)	Max switching frequency (f)	Repeat accuracy	Maximum linearity error	No-load supply current	Measure range	ORDERING REFERENCES	
		mm	mm	mm	mm	mm								INVERSELY PROPORTIONAL Graph 1	DIRECTLY PROPORTIONAL Graph 2
		mm	mm	mm	mm	mm									
A-7	•	-	43	15	8	66	6-8B-10	M12 x 1	250	0,5	5	4	1 ÷ 4	DCAL12/4309B	-
I-12	•	-	50	14	10	74	6-8B-10	M18 x 1	250	0,5	3	4	2 ÷ 7	DCAL18/4309B	DCAL18/4319B
I-12	•	10	50	14	10	84	6-8B-10	M18 x 1	250	0,5	3	4	3 ÷ 9	DCAL18/5309B	DCAL18/5319B

CYLINDRICAL INDUCTIVE SENSORS IN METAL HOUSING

- Diameters 30 - 80 mm
- Analog with linear current output
- Connector output M12 x 1

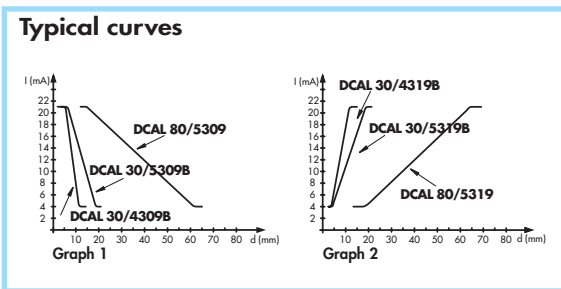
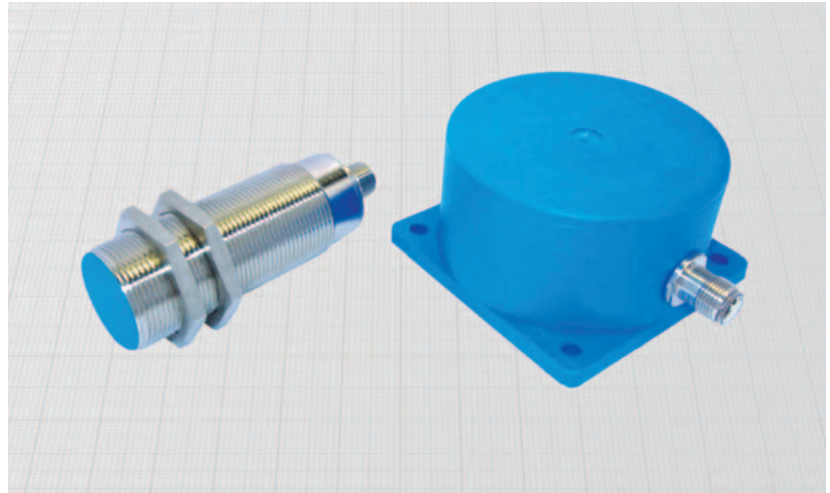
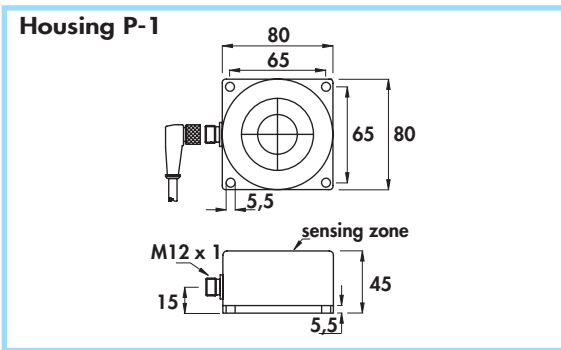
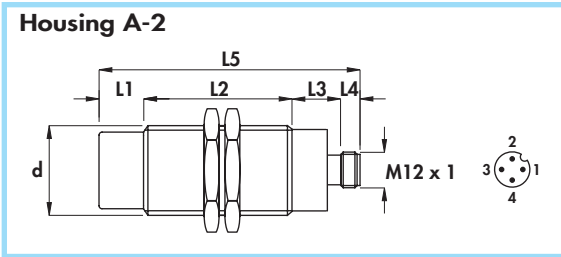

2 wires connection

Vout (V)	RL (ohm)	Vdc (min)
0,4 ... 2	100	15
2 ... 10	500	20
4 ... 20	1000	30

$RL (max) = \frac{[Vdc-10]}{20} K\Omega$

3 wires connection

Vout (V)	RL (ohm)	Vdc (min)
0 ... 1	62,5	11
0 ... 10	625	15
0 ... 16	1000	21
0 ... 20	1250	25
0 ... 30	1875	35

$RL (max) = \frac{[Vdc-5]}{16} K\Omega$

Diameter	M30 x 1,5	
Nut	Size	SW36
	Thickness mm	5
Max tightening torque Nm	80	

Materials:

- Housing 30 mm: nickel plated brass
- Housing 80 mm: plastic
- Sensing face: plastic

General Features:

These inductive proximity sensors provide an output current directly or reversely proportional to the distance between the sensing face and the metal target. The output current is also dependent by the material of the target, so they can be used not only to detect distances, displacements, vibrations and wavings but also to recognize the composition of metals and alloys. In the two wires configuration, they are reversal polarity and short circuit protected devices compliant to the 4-20 mA industrial standard.

It is recommended the use of connectors without LED.

For applications subjected to high levels of electromagnetic interferences, it is recommended the use of the straight connector with shielded cable type C10/00...V5 which offers a 360° shielding.

Use of the sensor:

The output current flows through the external load R_L generating a voltage (V_o) used to drive the input stage of the measuring instrument. The correct value of R_L can be chosen accordingly to the values of power supply V_{dc} and the wanted V_{out} range as reported on the tables.

Technical data:

- Supply voltage: 10 ÷ 40 Vdc
- Max ripple: 20%
- Output current range: 0 ÷ 16 mA or 4 ÷ 20 mA
- Temperature range: -10° ÷ +70°C
- Max thermal drift: < 10%
- Degree of protection: IP67
- Electromagnetic compatibility (EMC) according to EN61000-6-2/-4
- Shock and vibration resistance according to EN60068-2-27 EN60068-2-6

Housing	Flush mounting Non flush mounting	L1	L2	L3	L4	L5	Female connector	Body diameter (d)	Max switching frequency (f)	Repeat accuracy	Maximum linearity error	No-load supply current	Measure range	ORDERING REFERENCES	
		mm	mm	mm	mm	mm								INVERSELY PROPORTIONAL Graph 1	DIRECTLY PROPORTIONAL Graph 2
A-2	•	-	65	15	8	88	6-8B-10	M30 x 1,5	250	0,5	5	4	4 ÷ 12	DCAL30/4309B	DCAL30/4319B
A-2	•	15	50	15	8	88	6-8B-10	M30 x 1,5	250	0,5	5	4	5 ÷ 18	DCAL30/5309B	DCAL30/5319B
P-1	•	-	-	-	-	-	6-8B-10	80	250	0,5	5	4	20 ÷ 60	DCAL80/5309	DCAL80/5319

Analogue with linear voltage output •

Cable output •

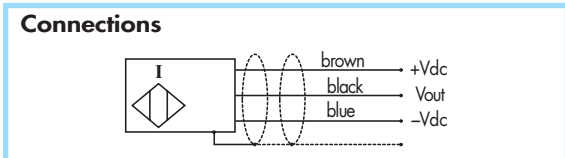
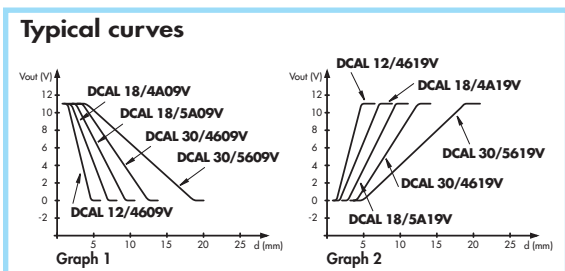
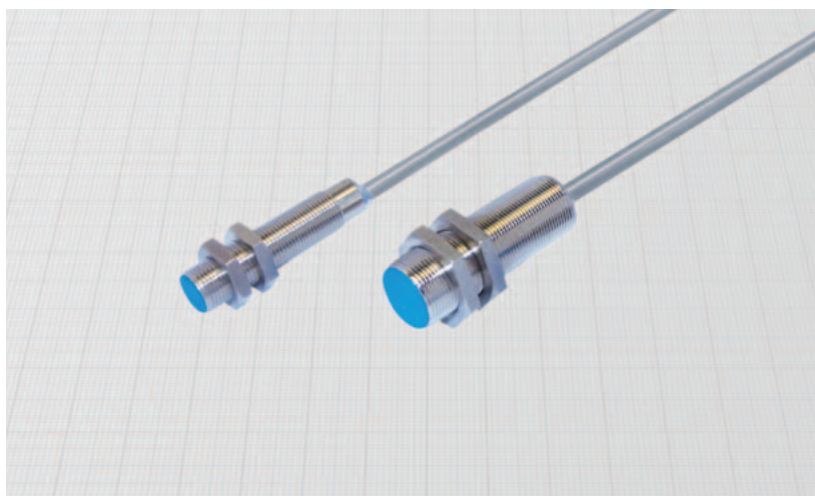
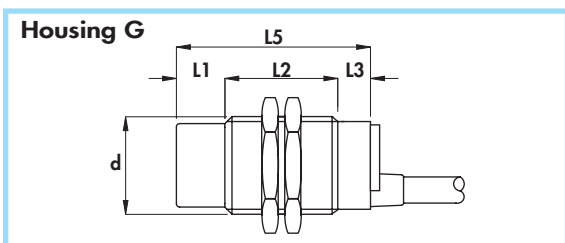
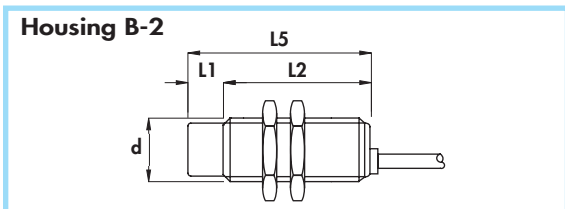
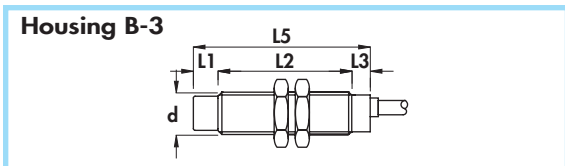

Diameter	M12 x 1	M18 x 1	M30 x 1,5
Nut	Size	SW17	SW24
	Thickness mm	4	4
Max tightening torque Nm	15	35	80

- Materials:**
- Cable: 2 m PVC CEI 20 - 22 II; 90°C; 300 V; O.R. shielded
 - Housing: nickel plated brass
 - Sensing face: plastic

General Features:
 These inductive proximity sensors provide an output voltage 0÷10V directly or reversely proportional to the distance between the sensing face and the metal target. The output voltage is also dependent by the material of the target, so they can be used not only to detect distances, displacements, vibrations and wavings but also to recognize the composition of metals and alloys.

- Technical data:**
- Supply voltage: 15 ÷ 40 Vdc
 - Max ripple: 20%
 - Voltage drop output: 0 ÷ 10 V
 - Temperature range: -10° ÷ +70°C
 - Max thermal drift: < 10%
 - Degree of protection: IP67
 - Cable conductor cross section: 0,22 mm² + shield on 12 mm, 0,35 mm² + shield on 18 - 30 mm
 - Electromagnetic compatibility (EMC) according to EN61000-6-2/-4
 - Shock and vibration resistance according to EN60068-2-27 EN60068-2-6

Housing	Flush mounting Non flush mounting	L1	L2	L3	L5	Cable diameter	Body diameter (d)	Max switching frequency (f)	Repeat accuracy	Maximum linearity error	No. load supply current	Measure range	ORDERING REFERENCES	
													INVERSELY PROPORTIONAL Graph 1	DIRECTLY PROPORTIONAL Graph 2
													mm	mm
B-3	•	-	43	7	50	4	M12 x 1	250	0,5	3	4	1 ÷ 4	DCAL12/4609V	DCAL12/4619V
B-2	•	-	50	-	50	5	M18 x 1	250	0,5	3	4	2 ÷ 7	DCAL18/4A09V	DCAL18/4A19V
B-2	•	10	40	-	50	5	M18 x 1	250	0,5	3	4	3 ÷ 9	DCAL18/5A09V	DCAL18/5A19V
G	•	-	50	10	60	5	M30 x 1,5	250	0,5	5	4	4 ÷ 12	DCAL30/4609V	DCAL30/4619V
G	•	15	35	10	60	5	M30 x 1,5	250	0,5	5	4	5 ÷ 18	DCAL30/5609V	DCAL30/5619V

CYLINDRICAL INDUCTIVE SENSORS IN METAL HOUSING

- Analog with linear voltage output
- Connector output M12 x 1

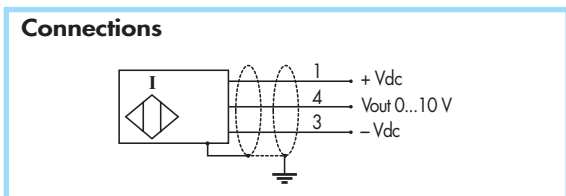
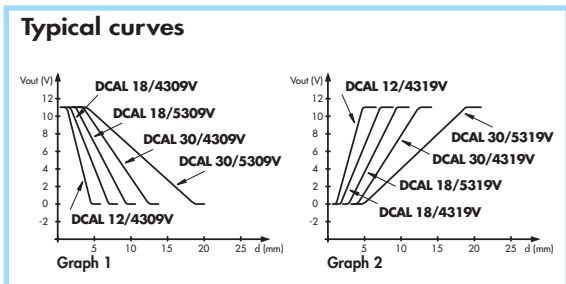
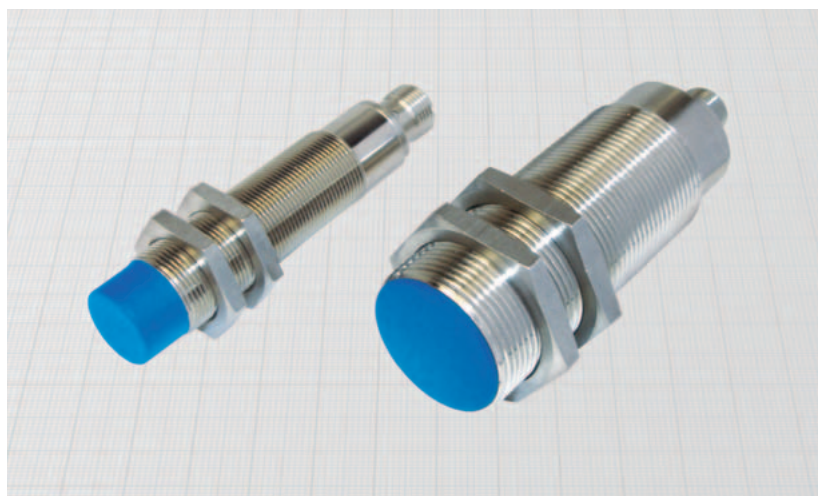
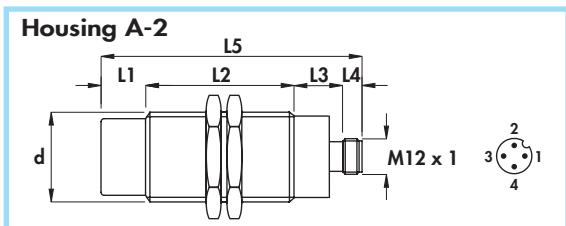
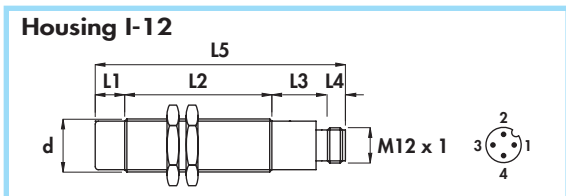
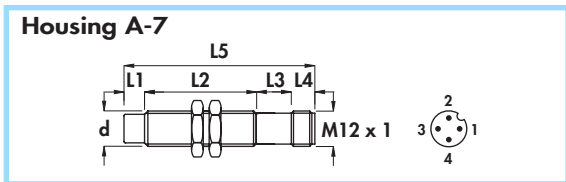

Diameter	M12 x 1	M18 x 1	M30 x 1,5
Nut	Size	SW17	SW24
	Thickness mm	4	4
Max tightening torque Nm	15	35	80

Materials:

- Housing: nickel plated brass
- Sensing face: plastic

General Features:

These inductive proximity sensors provide an output voltage $0 \div 10V$ directly or reversely proportional to the distance between the sensing face and the metal target. The output voltage is also dependent by the material of the target, so they can be used not only to detect distances, displacements, vibrations and wavings but also to recognize the composition of metals and alloys.

It is recommended the use of connectors without LED.

For applications subjected to high levels of electromagnetic interferences, it is recommended the use of the straight connector with shielded cable type C10/00...VS which offers a 360° shielding.

Technical data:

- Supply voltage: $15 \div 40 Vdc$
- Max ripple: 20%
- Output current range: $0 \div 10 V$
- Temperature range: $-10^{\circ} \div +70^{\circ}C$
- Max thermal drift: $< 10\%$
- Degree of protection: IP67
- Electromagnetic compatibility (EMC) according to EN61000-6-2/-4
- Shock and vibration resistance according to EN60068-2-27 EN60068-2-6

Housing	Flush mounting Non flush mounting	L1	L2	L3	L4	L5	Female connector	Body diameter (d)	Max switching frequency (f)	Repeat accuracy	Maximum linearity error	No-load supply current	Measure range	ORDERING REFERENCES								
		mm	mm	mm	mm	mm								n°	mm	Hz	%	%	mA	mm	INVERSELY PROPORTIONAL Graph 1	DIRECTLY PROPORTIONAL Graph 2
		mm	mm	mm	mm	mm															mm	mm
A-7	•	-	43	15	8	66	6-8B-10	M12 x 1	250	0,5	5	4	1 ÷ 4	DCAL12/4309V	DCAL12/4319V							
I-12	•	-	50	14	10	74	6-8B-10	M18 x 1	250	0,5	3	4	2 ÷ 7	DCAL18/4309V	DCAL18/4319V							
I-12	•	10	50	14	10	84	6-8B-10	M18 x 1	250	0,5	3	4	3 ÷ 9	DCAL18/5309V	DCAL18/5319V							
A-2	•	-	65	15	8	88	6-8B-10	M30 x 1,5	250	0,5	5	4	4 ÷ 12	DCAL30/4309V	DCAL30/4319V							
A-2	•	15	50	15	8	88	6-8B-10	M30 x 1,5	250	0,5	5	4	5 ÷ 18	DCAL30/5309V	DCAL30/5319V							

- 5 output functions •
- Amplified in d.c. + a.c. 2 wires •
- Cable output •

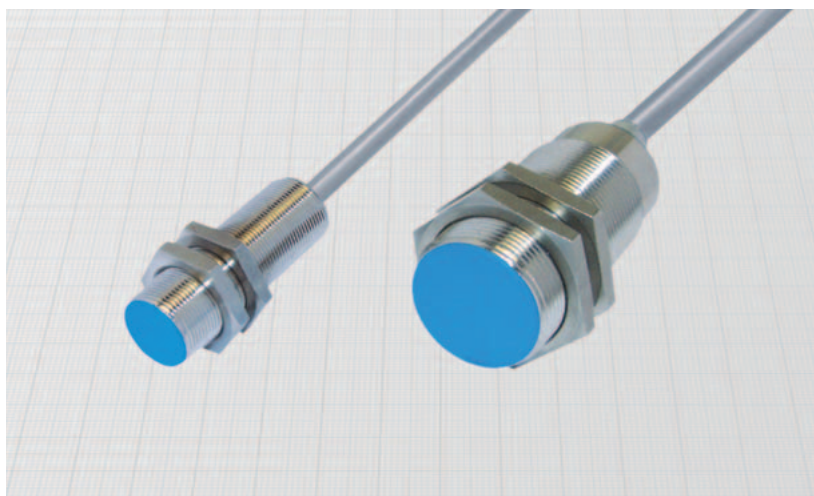
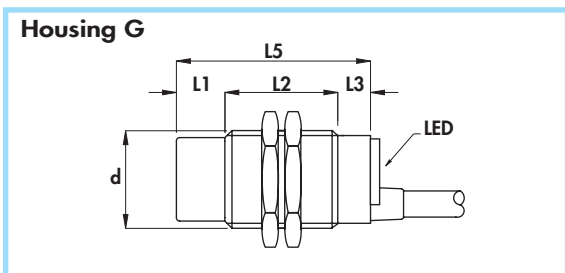
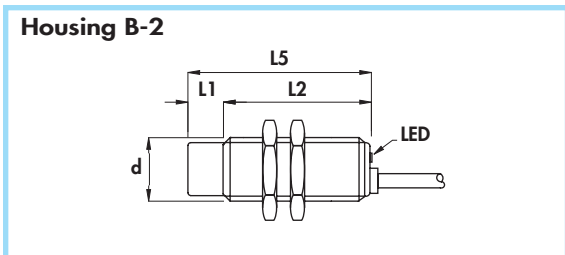

Diameter		M18 x 1	M30 x 1,5
Nut	Size	SW24	SW36
	Thickness mm	4	5
Max tightening torque Nm		35	80

Materials:

- Cable: 2 m PVC CEI 20 - 22 II; 90°C; 300 V; O.R.
- Housing: nickel plated brass
- Sensing face: plastic

General Features:

When used in a.c. they work as normally open. When used in d.c. they can work as normally open or normally closed simply by reversing the connection wires. The load can be connected indifferently on the positive or on the negative pole. These sensors put together the four functions of traditional 3 wires amplified sensors: PNP - NO; PNP - NC; NPN - NO; NPN - NC. Besides the a.c. working in many applications they can replace directly electromechanical microswitches.

Technical data:

- Supply voltage (U_B): 10 ÷ 60 Vdc/Vac
- Electrical system frequency: 40 ÷ 60 Hz
- Max ripple: 10%
- Off-state current (I_i): ≤ 0,6 mA
- Minimum operational current (I_m): 5 mA
- Rated operational current (I_o): 400 mA
- Voltage drop (U_d): ≤ 4 V
- Temperature range: -20° ÷ +70°C
- Max thermal drift of sensing distance S_r : ± 10%
- Repeat accuracy (R): 2%
- Switching hysteresis (H): 10%
- Degree of protection: IP67
- LED indication: yellow = output state
blinking red = output short circuit
- Cable conductor cross section: 0,75 mm²
- Protected against short-circuit and overload
- Suppression of initial false impulse
- Class 2 equipment according to IEC 536
- Shock and vibration according to EN60068-2-27 EN60068-2-6
- Electromagnetic compatibility (EMC) according to EN61000-6-2/-4

Housing	Flush mounting Non flush mounting	L1	L2	L3	L5	Cable diameter	Body diameter (d)	Max switching frequency (f)	Nominal sensing distance (S_n) ± 10%	ORDERING REFERENCES					
										PNP		NPN		A.C.	
										NO	NC	NO	NC	NO	
B - 2	•	-	50	-	50	5	M18 x 1	800	5		DX18/4A5XKS DX18/5A5XKS				
B - 2	•	10	40	-	50	5	M18 x 1	400	8						
G	•	-	50	10	60	5	M30 x 1,5	600	10	DX30/465XKS DX30/565XKS					
G	•	15	35	10	60	5	M30 x 1,5	300	15						

CYLINDRICAL INDUCTIVE SENSORS IN METAL HOUSING

- 5 output functions
- Amplified in d.c. + a.c. 2 wires
- Connector output M12 x 1

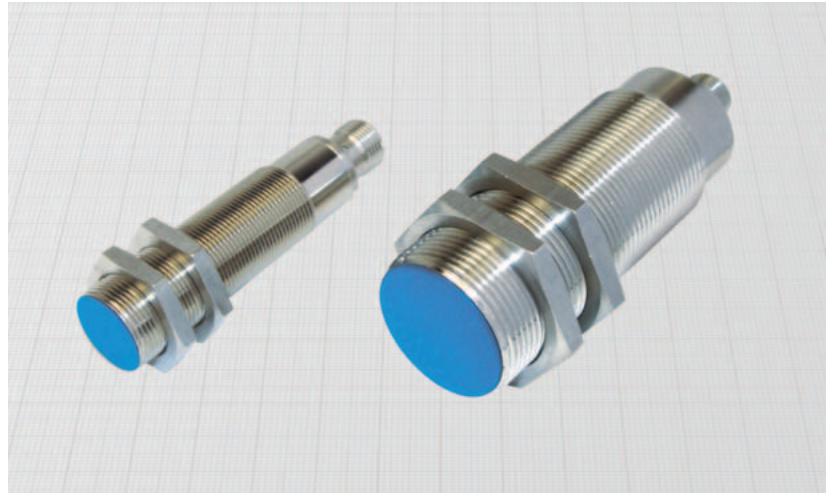
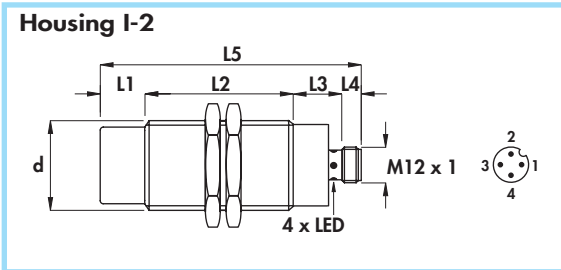
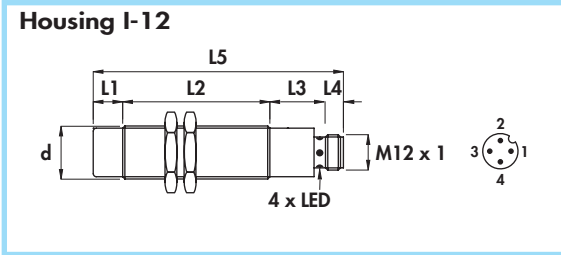

Diameter	M18 x 1	M30 x 1,5
Nut	Size	SW24
	Thickness mm	4
Max tightening torque Nm	35	80

Materials:

- Housing: nickel plated brass
- Sensing face: plastic

General Features:

When used in a.c. they work as normally open. When used in d.c. they can work as normally open or normally closed simply by reversing the connection wires. The load can be connected indifferently on the positive or on the negative pole. These sensors put together the four functions of traditional 3 wires amplified sensors besides the a.c. working. In many applications they can replace directly electromechanical microswitches.

Technical data:

- Supply voltage (U_B): 10 ÷ 60 Vdc/Vac
- Electrical system frequency: 40 ÷ 60 Hz
- Max ripple: 10%
- Off-state current (I_o): ≤ 0,6 mA
- Minimum operational current (I_m): 5 mA
- Voltage drop (U_d): ≤ 4 V
- Temperature range: -20° ÷ +70°C
- Max thermal drift of sensing distance S_s : ± 10%
- Repeat accuracy (R): 2%
- Switching hysteresis (H): 10%
- Degree of protection: IP67
- Switch status indicator: yellow LED
- Protected against short-circuit and overload
- Suppression of initial false impulse
- Class 2 equipment according to IEC 536
- Shock and vibration according to EN60068-2-27 EN60068-2-6
- Electromagnetic compatibility (EMC) according to EN60947-5-2

Housing	Flush mounting Non flush mounting	L1	L2	L3	L4	L5	Female connector	Body diameter (d)	Max switching frequency (f)	Rated operational current (I _e)	Nominal sensing distance (S _n) ± 10%	ORDERING REFERENCES				
												PNP		NPN		A.C.
												NO	NC	NO	NC	
I-12	•	-	50	19	8	77	6-8B-10	M18 x 1	800	400	5		DX18/435XKS DX18/535XKS			
I-12	•	10	50	19	8	87	6-8B-10	M18 x 1	400	400	8					
I-2	•	-	65	17	8	90	6-8B-10	M30 x 1,5	600	400	10		DX30/435XKS DX30/535XKS			
I-2	•	15	50	17	8	90	6-8B-10	M30 x 1,5	300	400	15					

Voltage 10 ÷ 50 V_~ •
 Amplified in d.c. + a.c. 2 wires •
 Cable output •

Housing B-6

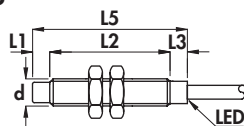

Housing B-3

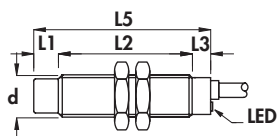

Housing C

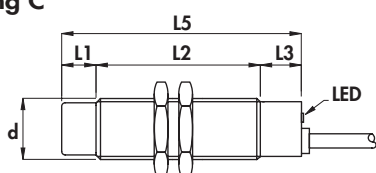

Housing G

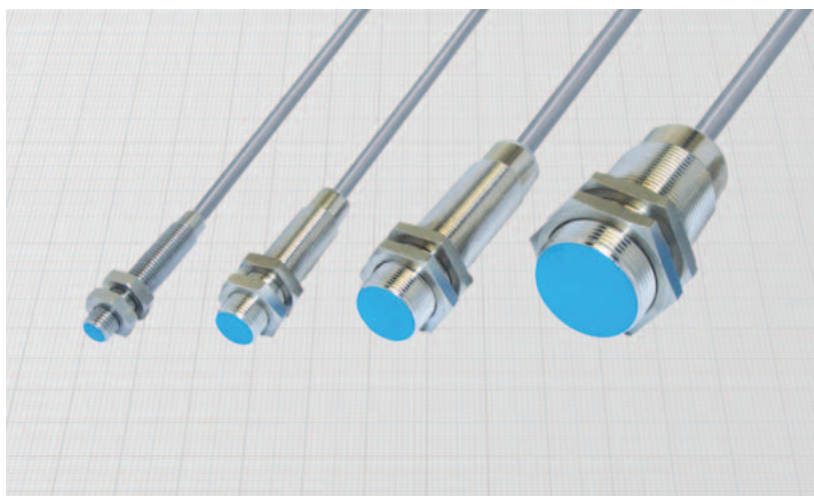
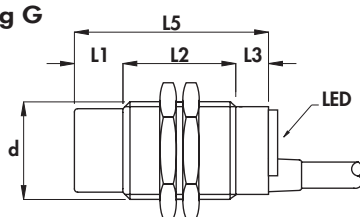

Diameter		M8 x 1	M12 x 1	M18 x 1	M30 x 1,5
Nut	Size	SW13	SW17	SW24	SW36
	Thickness mm	4	4	4	5
Max tightening torque Nm		10	15	35	80

Materials:

- Cable: 2 m PVC CEI 20 - 22 II; 90°C; 300 V; O.R.
- Housing 8 mm: stainless steel
- Housing 12 - 18 - 30 mm: nickel plated brass
- Sensing face: plastic

General Features:

These sensors are able to work with either direct or alternate current. Voltage drop and residual current are very low. They are not polarized and the load can be connected on both the leads. In many applications they can be used to replace mechanical microswitches.

Technical data:

- Supply voltage (U_B): 10 ÷ 50 Vdc/Vac
- Electrical system frequency: 40 ÷ 60 Hz
- Off-state current (I_o): ≤ 1 mA
- Minimum operational current (I_m): 5 mA
- Voltage drop (U_d): ≤ 5 V
- Temperature range: -25° ÷ +70°C
- Max thermal drift of sensing distance S_r : ± 10%
- Repeat accuracy (R): 2%
- Switching hysteresis (H): 10%
- Degree of protection: IP67
- Switch status indicator: yellow LED
- Cable conductor cross section: 0,35 mm² on 8 and 12 mm
0,50 mm² on 18 mm
0,75 mm² on 30 mm
- Protected against short-circuit and overload (versions with letter K)
- Suppression of initial false impulse
- Electromagnetic compatibility (EMC) according to EN60947-5-2
- Shock and vibration resistance according to EN60068-2-27 EN60068-2-6

Housing	Flush mounting Non flush mounting	L1	L2	L3	L4	L5	Cable diameter	Body diameter (d)	Max switching frequency (f) in d.c.	Max switching frequency (f) in a.c.	Rated operational current (I _o)	Nominal sensing distance (S _n) ± 10%	ORDERING REFERENCES	
													mm	mm
B-6	•	-	40	5	-	45	4	M8 x 1	1000	25	100	1,5	AXM8/4600S	AXM8/4610S
B-6	•	5	35	5	-	45	4	M8 x 1	800	25	100	2,5	AXM8/5600S	AXM8/5610S
B-3	•	-	43	7	-	50	4	M12 x 1	800	25	100	2	AXM12/4600KS	AXM12/4610KS
B-3	•	7	36	7	-	50	4	M12 x 1	600	25	100	4	AXM12/5600KS	AXM12/5610KS
C	•	-	58	12	-	70	5	M18 x 1	800	25	200	5	AXM18/4600KS	AXM18/4610KS
C	•	10	48	12	-	70	5	M18 x 1	400	25	200	8	AXM18/5600KS	AXM18/5610KS
G	•	-	50	10	-	60	6	M30 x 1,5	400	25	200	10	AXM30/4600KS	AXM30/4610KS
G	•	15	35	10	-	60	6	M30 x 1,5	200	25	200	15	AXM30/5600KS	AXM30/5610KS

CYLINDRICAL INDUCTIVE SENSORS IN METAL HOUSING

- Supply 10 ÷ 50 V \approx
- Amplified in d.c. + a.c.
- Connector output M12 x 1

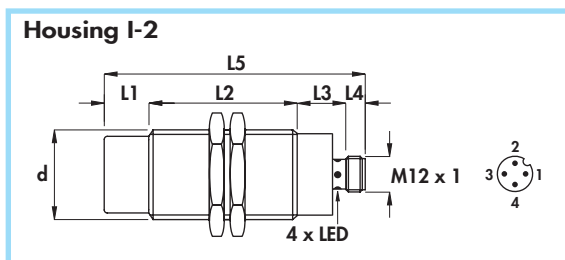
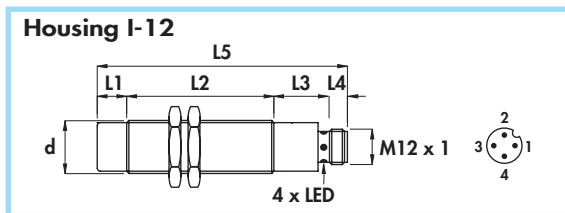
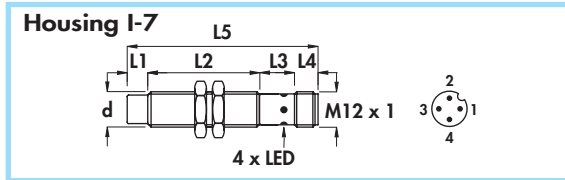
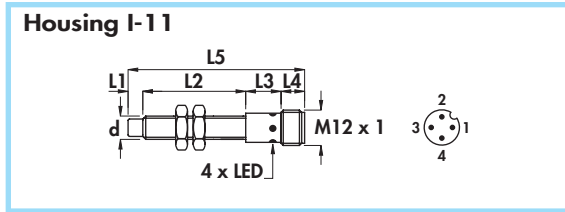

Diameter	M8 x 1	M12 x 1	M18 x 1	M30 x 1,5
Nut	Size	SW13	SW17	SW24
	Thickness mm	4	4	4
Max tightening torque Nm	10	15	35	80

Materials:

- Housing 8 mm: stainless steel
- Housing 12 - 18 - 30 mm: nickel plated brass
- Sensing face: plastic

General Features:

These sensors are able to work with either direct or alternate current. Voltage drop and residual current are very low. They are not polarized and the load can be connected on both the leads. In many applications they can be used to replace mechanical microswitches.

Technical data:

- Supply voltage (U_B): 10 ÷ 50 Vdc/Vac
- Electrical system frequency: 40 ÷ 60 Hz
- Off-state current (I_f): ≤ 1 mA
- Minimum operational current (I_m): 5 mA
- Voltage drop (U_d): ≤ 5 V
- Temperature range: -25° ÷ +70°C
- Max thermal drift of sensing distance S_T : $\pm 10\%$
- Repeat accuracy (R): 2%
- Switching hysteresis (H): 10%
- Degree of protection: IP67
- Switch status indicator: yellow LED
- Protected against short-circuit and overload (versions with letter K)
- Suppression of initial false impulse
- Electromagnetic compatibility (EMC) according to EN60947-5-2
- Shock and vibration resistance according to EN60068-2-27 EN60068-2-6

Housing	Flush mounting Non flush mounting	L1	L2	L3	L4	L5	Female connector	Body diameter (d)	Max switching frequency (f) in d.c.	Max switching frequency (f) in a.c.	Rated operational current (I_e)	Nominal sensing distance (S_n) $\pm 10\%$	ORDERING REFERENCES		
													mm	mm	mm
I-11	•	-	40	12	8	60	6-8B-10	M8 x 1	1000	25	100	1,5		AXM8/4300S	AXM8/4310S
I-11	•	5	35	12	8	60	6-8B-10	M8 x 1	800	25	100	2,5		AXM8/5300S	AXM8/5310S
I-7	•	-	43	15	8	66	6-8B-10	M12 x 1	800	25	100	2		AXM12/4300KS	AXM12/4310KS
I-7	•	7	36	15	8	66	6-8B-10	M12 x 1	600	25	100	4		AXM12/5300KS	AXM12/5310KS
I-12	•	-	50	19	8	77	6-8B-10	M18 x 1	800	25	200	5		AXM18/4300KS	AXM18/4310KS
I-12	•	10	50	19	8	87	6-8B-10	M18 x 1	400	25	200	8		AXM18/5300KS	AXM18/5310KS
I-2	•	-	65	17	8	90	6-8B-10	M30 x 1,5	400	25	200	10		AXM30/4300KS	AXM30/4310KS
I-2	•	15	50	17	8	90	6-8B-10	M30 x 1,5	200	25	200	15		AXM30/5300KS	AXM30/5310KS

Voltage 20 ÷ 240 V_~ •
Amplified in d.c. + a.c. 2 wires •
Cable output •

Housing B-6

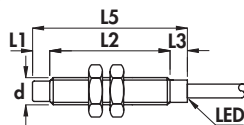

Housing B-3

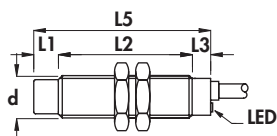

Housing B-2

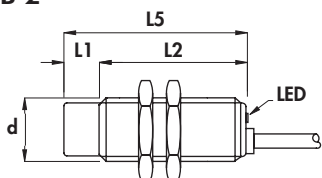

Housing G

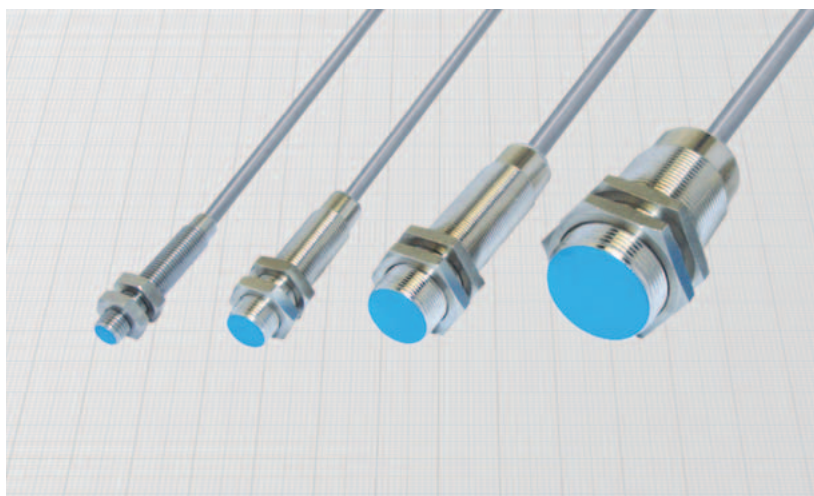
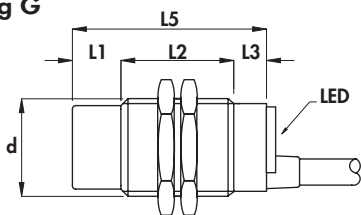

Diameter		M8 x 1	M12 x 1	M18 x 1	M30 x 1,5
Nut	Size	SW13	SW17	SW24	SW36
	Thickness mm	4	4	4	5
Max tightening torque Nm		10	15	35	80

Materials:

- Cable: 2 m PVC CEI 20 - 22 II; 90°C; 300 V; O.R.
- Housing 8 mm: stainless steel
- Housing 12-18 - 30 mm: nickel plated brass
- Sensing face: plastic

General Features:

These sensors are able to work with either direct or alternate current. Voltage drop and residual current are very low. They are not polarized and the load can be connected on both the leads. In many applications they can be used to replace mechanical microswitches.

Technical data:

- Supply voltage (U_B): 20 ÷ 240 Vdc/Vac
- Electrical system frequency: 40 ÷ 60 Hz
- Off-state current (I_o) at 24 V: ≤ 1 mA
- Off-state current (I_o) at 220 V: ≤ 1,5 mA
- Minimum operational current (I_m): 5 mA
- Voltage drop (U_d): ≤ 5 V
- Temperature range: - 25° ÷ + 70°C
- Max thermal drift of sensing distance S_r: ± 10%
- Repeat accuracy (R): 2%
- Switching hysteresis (H): 10%
- Degree of protection: IP67
- Switch status indicator: yellow LED
- Cable conductor cross section: 0,35 mm² on 8 and 12 mm
0,50 mm² on 18 mm
0,75 mm² on 30 mm

- Protected against short-circuit and overload (versions with letter K)
- Suppression of initial false impulse
- Class 2 equipment according to IEC 536
- Shock and vibration according to EN60068-2-27 EN60068-2-6
- Electromagnetic compatibility (EMC) according to EN60947-5-2

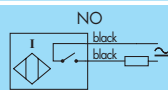
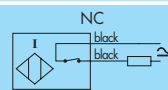
Housing	Mounting Flush mounting Non flush mounting	L1	L2	L3	L4	L5	Cable diameter	Body diameter (d)	Max switching frequency (f) in d.c.	Max switching frequency (f) in a.c.	Rated operational current (I _e)	Nominal sensing distance (S _n) ± 10%	ORDERING REFERENCES	
		mm	mm	mm	mm	mm								
B-6	•	-	40	5	-	45	3,5	M8 x 1	1000	25	100	1,5	AX8/4609S	AX8/4619S
B-6	•	5	35	5	-	45	3,5	M8 x 1	800	25	100	2,5	AX8/5609S	AX8/5619S
B-3	•	-	43	7	-	50	4	M12 x 1	800	25	100	2	AX12/4609KS	AX12/4619KS
B-3	•	7	36	7	-	50	4	M12 x 1	600	25	100	4	AX12/5609KS	AX12/5619KS
B-2	•	-	50	-	-	50	5	M18 x 1	800	25	200	5	AX18/4A09KS	AX18/4A19KS
B-2	•	10	40	-	-	50	5	M18 x 1	400	25	200	8	AX18/5A09KS	AX18/5A19KS
G	•	-	50	10	-	60	6	M30 x 1,5	400	25	200	10	AX30/4609KS	AX30/4619KS
G	•	15	35	10	-	60	6	M30 x 1,5	200	25	200	15	AX30/5609KS	AX30/5619KS

CYLINDRICAL INDUCTIVE SENSORS IN METAL HOUSING

- Voltage 20 ÷ 240 V \approx
- Amplified in d.c. + a.c.
- Connector output M12 x 1

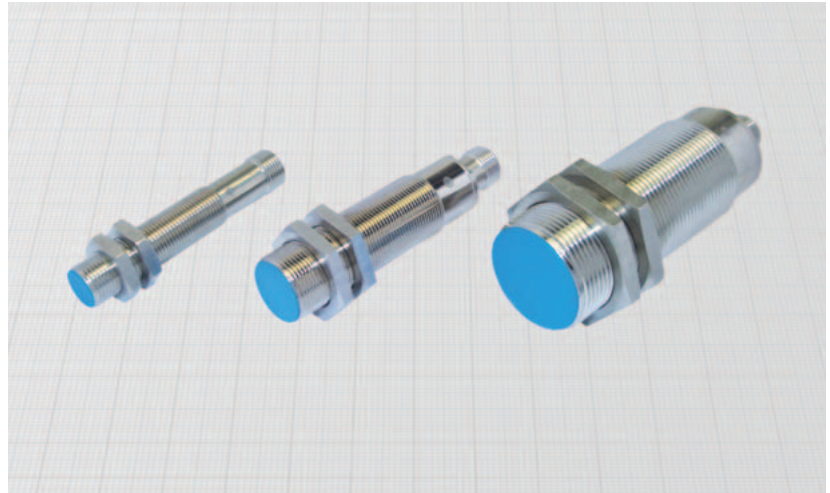
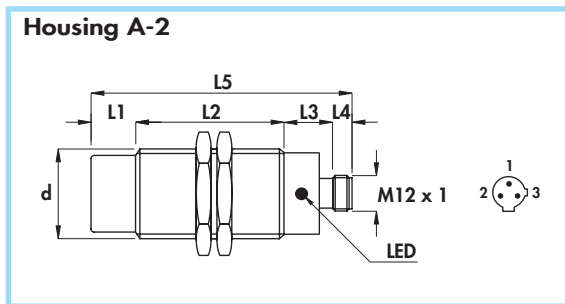
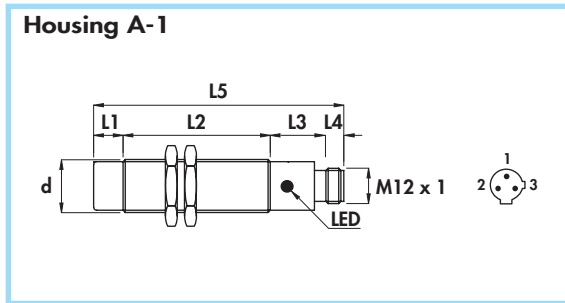
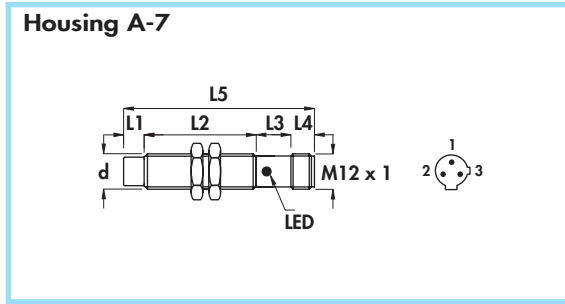

Diameter		M12x 1	M18 x 1	M30 x 1,5
Nut	Size	SW17	SW24	SW36
	Thickness mm	4	4	5
Max tightening torque Nm		15	35	80

Materials:

- Housing: nickel plated brass
- Sensing face: plastic

General Features:

These sensors are able to work with either direct or alternate current. Voltage drop and residual current are very low. They are not polarized and the load can be connected on both the leads. In many applications they can be used to replace mechanical microswitches.

Technical data:

- Supply voltage (U_B): 20 ÷ 240 Vdc/Vac
- Electrical system frequency: 40 ÷ 60 Hz
- Off-state current (I_o) at 24 V: ≤ 1 mA
- Off-state current (I_o) at 220 V: $\leq 1,5$ mA
- Minimum operational current (I_m): 5 mA
- Voltage drop (U_d): ≤ 5 V
- Temperature range: -25° ÷ +70°C
- Max thermal drift of sensing distance S_p : $\pm 10\%$
- Repeat accuracy (R): 2%
- Switching hysteresis (H): 10%
- Degree of protection: IP67
- Switch status indicator: yellow LED
- Protected against short-circuit and overload
- Suppression of initial false impulse
- Class 2 equipment according to IEC 536
- Shock and vibration according to EN60068-2-27 EN60068-2-6
- Electromagnetic compatibility (EMC) according to EN60947-5-2

Housing	Flush mounting Non flush mounting	L1	L2	L3	L4	L5	Female connector	Body diameter (d)	Max switching frequency (f) in d.c.	Max switching frequency (f) in a.c.	Rated operational current (I_o)	Nominal sensing distance (S_p) $\pm 10\%$	ORDERING REFERENCES	
		mm	mm	mm	mm	mm							n°	mm
A-7	•	-	43	15	8	66	17-18	M12 x 1	800	25	100	2	AX12/4009KS	AX12/4019KS
A-7	•	7	36	15	8	66	17-18	M12 x 1	600	25	100	4	AX12/5009KS	AX12/5019KS
A-1	•	-	50	19	8	77	17-18	M18 x 1	800	25	200	5	AX18/4009KS	AX18/4019KS
A-1	•	10	50	19	8	87	17-18	M18 x 1	400	25	200	8	AX18/5009KS	AX18/5019KS
A-2	•	-	65	17	8	90	17-18	M30 x 1,5	400	25	200	10	AX30/4009KS	AX30/4019KS
A-2	•	15	50	17	8	90	17-18	M30 x 1,5	200	25	200	15	AX30/5009KS	AX30/5019KS

Diameters 12 - 18 mm •
 Amplified in a.c. 2 wires •
 Cable output •

Housing B-3

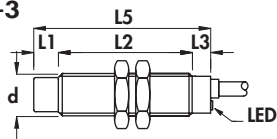

Housing D

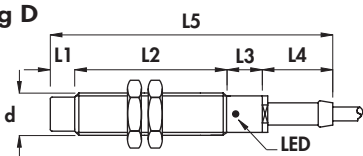

Housing B-2

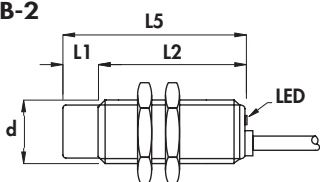

Housing C

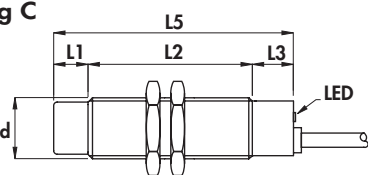

Housing D-1

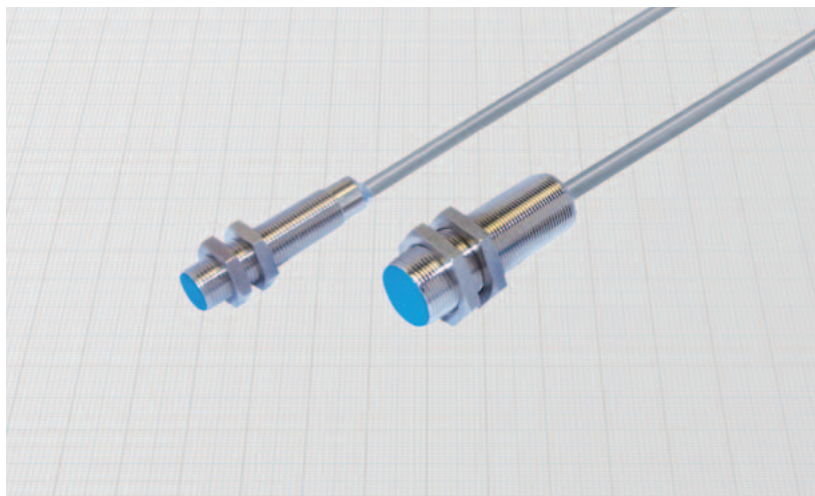
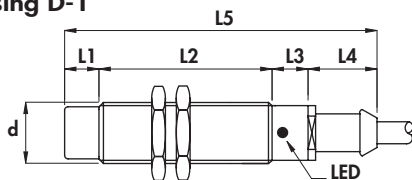

Diameter		M12 x 1	M18 x 1
Nut	Size	SW17	SW24
	Thickness mm	4	4
Max tightening torque Nm		15	35

Materials:

- Cable: 2 m PVC CEI 20 - 22 II; 90°C; 300 V; O.R.
- Housing: nickel plated brass
- Sensing face: plastic

Technical data:

- Supply voltage (U_B): 20 ÷ 240 Vac
- Electrical system frequency: 40 ÷ 60 Hz
- Off-state current (I_o): ≤1,5 mA at 110 Vac
- Minimum operational current (I_m): 5 mA
- Voltage drop (U_d): ≤ 5 V
- Temperature range: -25° ÷ +70°C
- Max thermal drift of sensing distance S_r : ± 10%
- Repeat accuracy (R): 2%
- Switching hysteresis (H): 10%
- Degree of protection: IP67
- Switch status indicator: yellow LED
- Cable conductor cross section: 0,35 mm² on 12 mm
0,50 mm² on 18 mm (Housing C)
0,75 mm² on 18 mm (Housing D - 1)

- Suppression of initial false impulse
- Class 2 equipment according to IEC 536
- Shock and vibration according to EN60068-2-27 EN60068-2-6
- Electromagnetic compatibility (EMC) according to EN60947-5-2

Housing	Flush mounting Non flush mounting	L1	L2	L3	L4	L5	Cable diameter	Body diameter (d)	Max switching frequency (f)	Rated operational current (I _o)	Nominal sensing distance (S _n) ± 10%	ORDERING REFERENCES	
												mm	mm
B - 3	•	-	43	7	-	50	4	M12 x 1	25	500	2	AC12/4609S	AC12/4619S
D	•	-	50	10	20	80	4	M12 x 1	25	500	2	AC12/4709S	AC12/4719S
B - 3	•	7	36	7	-	50	4	M12 x 1	25	500	4	AC12/5609S	AC12/5619S
D	•	7	43	10	20	80	4	M12 x 1	25	500	4	AC12/5709S	AC12/5719S
C	•	-	60	10	-	70	5	M18 x 1	25	500	5	AC18/4609S	AC18/4619S
B - 2	•	-	50	-	-	50	5	M18 x 1	25	500	5	AC18/4A09S	AC18/4A19S
D - 1	•	-	60	12	20	92	6	M18 x 1	25	500	5	AC18/4709S	AC18/4719S
B - 2	•	10	40	-	-	50	5	M18 x 1	25	500	8	AC18/5A09S	AC18/5A19S
D - 1	•	10	50	12	20	92	6	M18 x 1	25	500	8	AC18/5709S	AC18/5719S
C	•	10	50	10	-	70	5	M18 x 1	25	500	8	AC18/5609S	AC18/5619S

CYLINDRICAL INDUCTIVE SENSORS IN METAL HOUSING

- Diameters 30 - 45 mm
- Amplified in a.c. 2 wires
- Cable output

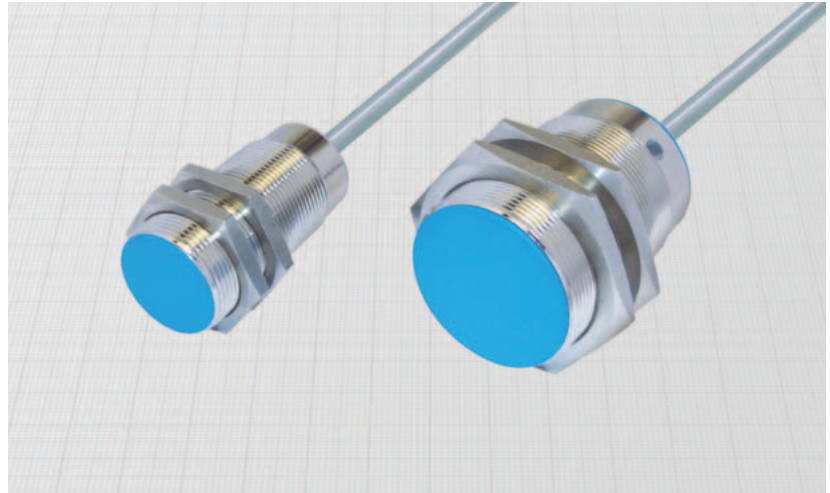
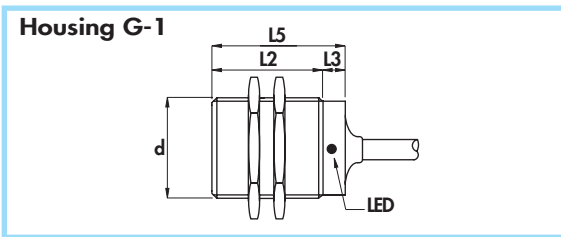
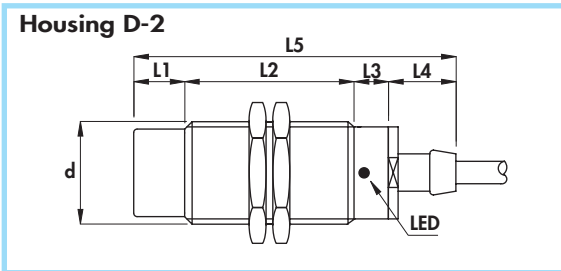
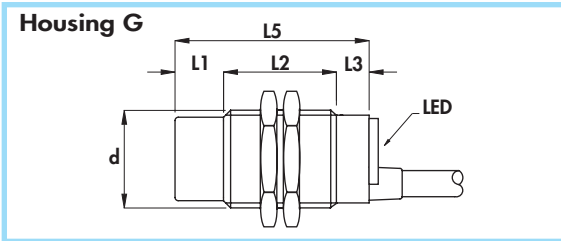

Diameter	M30 x 1,5	M45 x 1,5
Nut	Size	SW17
	Thickness mm	5
Max tightening torque Nm	80	70

Materials:

- Cable: 2 m PVC CEI 20 - 22 II; 90°C; 300 V; O.R.
- Housing: nickel plated brass
- Sensing face: plastic

Technical data:

- Supply voltage (U_B): 20 ÷ 240 Vac
- Electrical system frequency: 40 ÷ 60 Hz
- Off-state current (I_o): ≤ 1,5 mA at 110 Vac
- Minimum operational current (I_m): 5 mA
- Voltage drop (U_d): ≤ 5 V
- Temperature range: - 25° ÷ + 70°C
- Max thermal drift of sensing distance S_r : ± 10%
- Repeat accuracy (R): 2%
- Switching hysteresis (H): 10%
- Degree of protection: IP67
- Switch status indicator: yellow LED
- Cable conductor cross section: 0,75 mm²
- Suppression of initial false impulse
- Class 2 equipment according to IEC 536
- Shock and vibration according to EN60068-2-27 EN60068-2-6
- Electromagnetic compatibility (EMC) according to EN60947-5-2

Housing	Flush mounting Non flush mounting	L1	L2	L3	L4	L5	Cable diameter	Body diameter (d)	Max switching frequency (f)	Rated operational current (I _o)	Nominal sensing distance (S _n) ± 10%	ORDERING REFERENCES	
		mm	mm	mm	mm	mm						mm	mm
G	•	-	50	10	-	60	6	M30 x 1,5	20	500	10	AC30/4609S	AC30/4619S
D-2	•	-	65	10	20	95	6	M30 x 1,5	20	500	10	AC30/4709S	AC30/4719S
G	•	15	35	10	-	60	6	M30 x 1,5	20	500	15	AC30/5609S	AC30/5619S
D-2	•	15	50	10	20	95	6	M30 x 1,5	20	500	15	AC30/5709S	AC30/5719S
G-1	•	-	50	10	-	60	6	M45 x 1,5	20	500	20	AC45/4609S	AC45/4619S

Diameters 12 - 18 mm •
 Amplified in a.c. •
 Connector output M12 x 1 •

Housing A-7

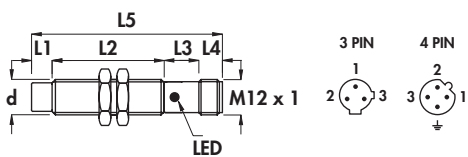

Housing A-1

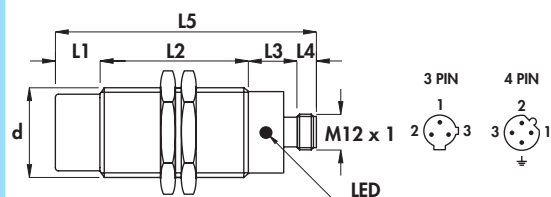

Diameter		M12 x 1	M18 x 1
Nut	Size	SW17	SW24
	Thickness mm	4	4
Max tightening torque Nm		15	35

Materials:

- Housing: nickel plated brass
- Sensing face: plastic

Technical data:

- Supply voltage (U_B): 20 ÷ 240 Vac
- Electrical system frequency: 40 ÷ 60 Hz
- Off-state current (I_o): ≤ 1,5 mA at 110 Vac
- Minimum operational current (I_m): 5 mA
- Voltage drop (U_d): ≤ 5 V
- Temperature range: -25° ÷ +70°C
- Max thermal drift of sensing distance S_r : ± 10%
- Repeat accuracy (R): 2%
- Switching hysteresis (H): 10%
- Degree of protection: IP67
- Switch status indicator: yellow LED
- Suppression of initial false impulse
- Shock and vibration according to EN60068-2-27 EN60068-2-6
- Electromagnetic compatibility (EMC) according to EN60947-5-2

Housing	Flush mounting Non flush mounting	L1	L2	L3	L4	L5	Female connector	Body diameter (d)	Max switching frequency (f)	Rated operational current (I _o)	Nominal sensing distance (S _r) ± 10%	ORDERING REFERENCES	
												4 PIN connector	
A-7	•	-	43	15	8	66	15 - 16	M12 x 1	25	500	2		
A-7	•	7	36	15	8	66	15 - 16	M12 x 1	25	500	4	AC12/4109S AC12/5109S	AC12/4119S AC12/5119S
A-1	•	-	50	19	8	77	15 - 16	M18 x 1	25	500	5		
A-1	•	10	50	19	8	87	15 - 16	M18 x 1	25	500	8	AC18/4109S AC18/5109S	AC18/4119S AC18/5119S

Housing	Flush mounting Non flush mounting	L1	L2	L3	L4	L5	Female connector	Body diameter (d)	Max switching frequency (f)	Rated operational current (I _o)	Nominal sensing distance (S _r) ± 10%	3 PIN connector according to EN60947-5-2	
												3 PIN connector	
A-7	•	-	43	15	8	66	17 - 18	M12 x 1	25	500	2		
A-7	•	7	36	15	8	66	17 - 18	M12 x 1	25	500	4	AC12/4009S AC12/5009S	AC12/4019S AC12/5019S
A-1	•	-	50	19	8	77	17 - 18	M18 x 1	25	500	5		
A-1	•	10	50	19	8	87	17 - 18	M18 x 1	25	500	8	AC18/4009S AC18/5009S	AC18/4019S AC18/5019S

CYLINDRICAL INDUCTIVE SENSORS IN METAL HOUSING

- Diameter 30 mm
- Amplified in a.c.
- Connector output M12 x 1

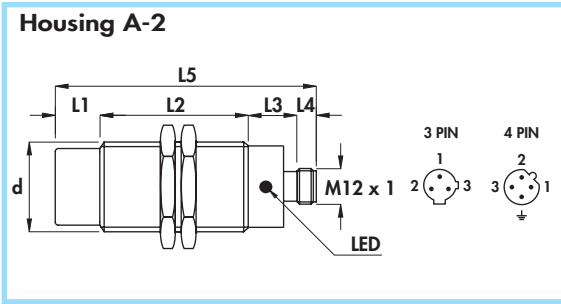

Diameter	M30 x 1,5	
Nut	Size	SW36
	Thickness mm	5
Max tightening torque Nm	80	



Materials:

- Housing: nickel plated brass
- Sensing face: plastic

Technical data:

- Supply voltage (U_B): 20 ÷ 240 Vac
- Electrical system frequency: 40 ÷ 60 Hz
- Off-state current (I_o): ≤ 1,5 mA a 110 Vac
- Minimum operational current (I_m): 5 mA
- Voltage drop (U_d): ≤ 5 V
- Temperature range: - 25° ÷ + 70°C
- Max thermal drift of sensing distance S_r : ± 10%
- Repeat accuracy (R): 2%
- Switching hysteresis (H): 10%
- Degree of protection: IP67
- Switch status indicator: yellow LED
- Suppression of initial false impulse
- Electromagnetic compatibility (EMC) according to EN60947-5-2
- Shock and vibration resistance according to EN60068-2-27 EN60068-2-6

Housing	Flush mounting Non flush mounting	L1	L2	L3	L4	L5	Female connector	Body diameter (d)	Max switching frequency (f)	Rated operational current (I _e)	Nominal sensing distance (S _n) ± 10%	ORDERING REFERENCES	
												4 PIN connector	
A-2	•	-	65	17	8	90	15 - 16	M30 x 1,5	20	500	10		
A-2	•	15	50	17	8	90	15 - 16	M30 x 1,5	20	500	15	AC30/4109S AC30/5109S	AC30/4119S AC30/5119S

Housing	Flush mounting Non flush mounting	L1	L2	L3	L4	L5	Female connector	Body diameter (d)	Max switching frequency (f)	Rated operational current (I _e)	Nominal sensing distance (S _n) ± 10%	3 PIN connector according to EN60947-5-2	
												3 PIN connector according to EN60947-5-2	
A-2	•	-	65	17	8	90	17 - 18	M30 x 1,5	20	500	10		
A-2	•	15	50	17	8	90	17 - 18	M30 x 1,5	20	500	15	AC30/4009S AC30/5009S	AC30/4019S AC30/5019S

Diameter 18 mm •
Amplified in a.c. •
Connector output C1 - C2 •

Housing M-1

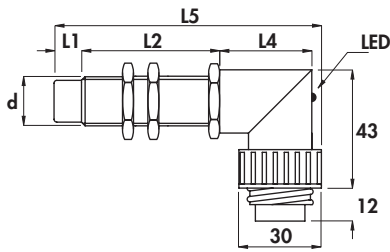

Housing M-4

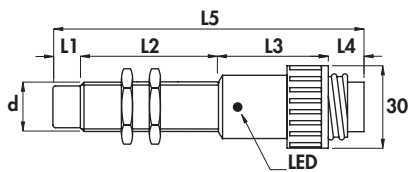

Housing M

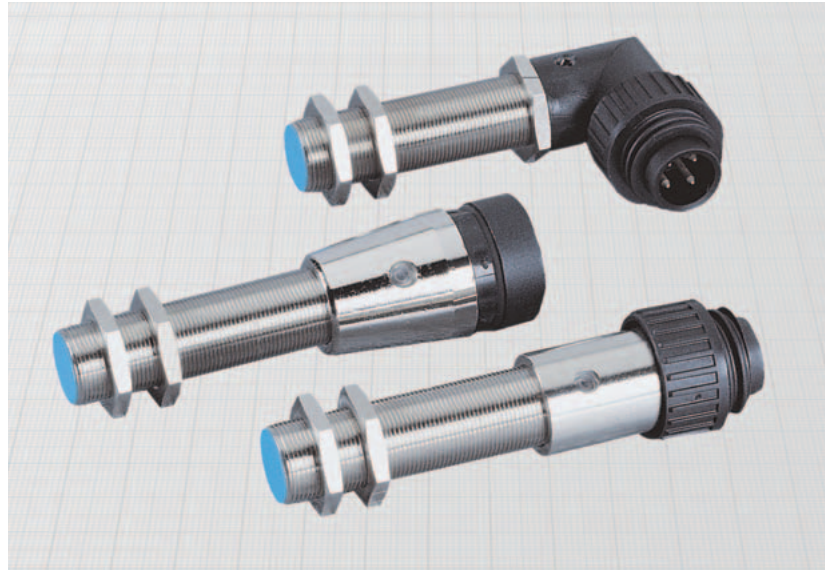
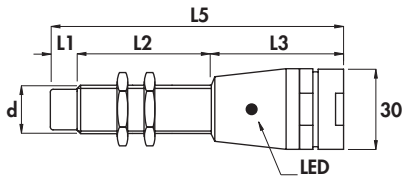

Diameter	M18 x 1	
Nut	Size	SW24
	Thickness mm	4
Max tightening torque Nm	35	

Materials:

- Housing: nickel plated brass
- Sensing face and connector: plastic

Technical data:

- Supply voltage (U_B): 20 ÷ 240 Vac
- Electrical system frequency: 40 ÷ 60 Hz
- Off-state current (I_o): ≤ 1,5 mA at 110 Vac
- Minimum operational current (I_m): 5 mA
- Voltage drop (U_d): ≤ 5 V
- Temperature range: -25° ÷ +70°C
- Max thermal drift of sensing distance S_r : ± 10%
- Repeat accuracy (R): 2%
- Switching hysteresis (H): 10%
- Degree of protection: IP65
- Switch status indicator: yellow LED
- Suppression of initial false impulse
- Electromagnetic compatibility (EMC) according to EN60947-5-2
- Shock and vibration resistance according to EN60068-2-27 EN60068-2-6

Housing	Mounting Flush mounting Non flush mounting	L1	L2	L3	L4	L5	Female connector	Body diameter (d)	Max switching frequency (f)	Rated operational current (I _o)	Nominal sensing distance (S _r) ± 10%	ORDERING REFERENCES	
		mm	mm	mm	mm	mm						n°	mm
M-1	•	-	60	-	33	96	1	M18 x 1	25	500	5	AC18/4209S	AC18/4219S
M-4	•	-	60	40	13	113	1	M18 x 1	25	500	5	AC18/4409S	AC18/4419S
M-1	•	10	50	-	33	96	1	M18 x 1	25	500	8	AC18/5209S	AC18/5219S
M-4	•	10	50	40	13	113	1	M18 x 1	25	500	8	AC18/5409S	AC18/5419S
M	•	-	60	50	-	110	2	M18 x 1	25	500	5	AC18/4E09S	AC18/4E19S
M	•	10	50	50	-	110	2	M18 x 1	25	500	8	AC18/5E09S	AC18/5E19S

CYLINDRICAL INDUCTIVE SENSORS IN METAL HOUSING

- Diameters 30 - 45 mm
- Amplified in a.c.
- Connector output C1 - C2

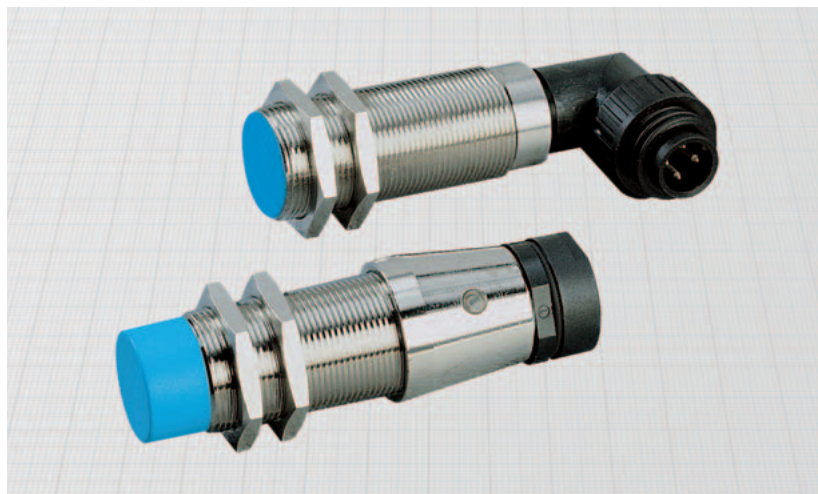
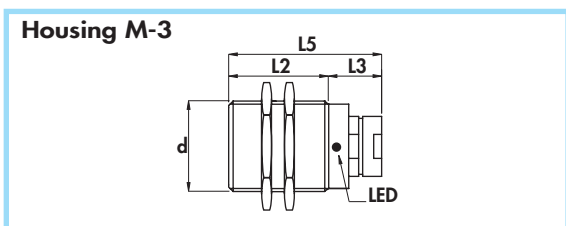
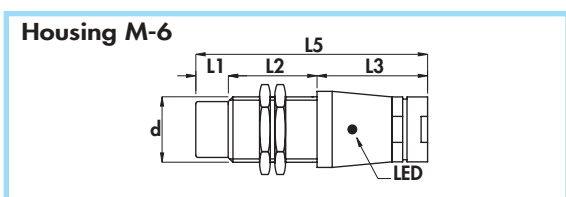
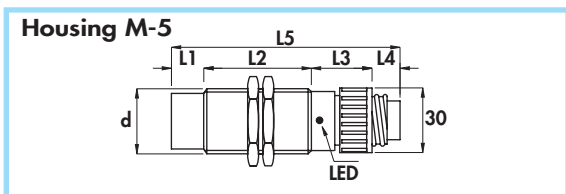
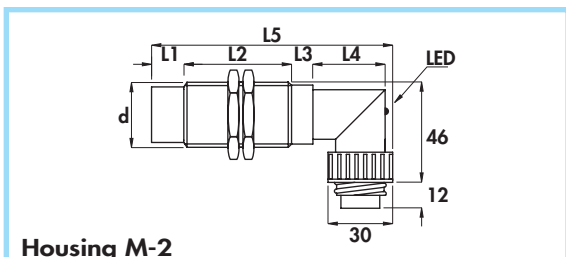

Diameter	M30 x 1,5	M45 x 1,5
Nut	Size	SW36
	Thickness mm	5
Max tightening torque Nm	80	70

Materials:

- Housing: nickel plated brass
- Sensing face and connector: plastic

Technical data:

- Supply voltage (U_B): 20 ÷ 240 Vac
- Electrical system frequency: 40 ÷ 60 Hz
- Off-state current (I_f): ≤ 1,5 mA a 110 Vac
- Minimum operational current (I_m): 5 mA
- Voltage drop (U_d): ≤ 5 V
- Temperature range: -25° ÷ +70°C
- Max thermal drift of sensing distance S_T : ± 10%
- Repeat accuracy (R): 2%
- Switching hysteresis (H): 10%
- Degree of protection: IP65
- Switch status indicator: yellow LED
- Suppression of initial false impulse
- Electromagnetic compatibility (EMC) according to EN60947-5-2
- Shock and vibration resistance according to EN60068-2-27 EN60068-2-6

Housing	Flush mounting Non flush mounting	L1	L2	L3	L4	L5	Female connector	Body diameter (d)	Max switching frequency (f ₁)	Rated operational current (I _e)	Nominal sensing dist. (S _n) ± 10%	ORDERING REFERENCES	
		mm	mm	mm	mm	mm						n°	mm
M-2	•	-	65	10	40	115	1	M30 x 1,5	20	500	10	AC30/4209S	AC30/4219S
M-5	•	-	65	28	13	106	1	M30 x 1,5	20	500	10	AC30/4409S	AC30/4419S
M-2	•	15	50	10	40	115	1	M30 x 1,5	20	500	15	AC30/5209S	AC30/5219S
M-5	•	15	50	28	13	106	1	M30 x 1,5	20	500	15	AC30/5409S	AC30/5419S
M-2	•	-	50	10	42	102	1	M45 x 1,5	20	500	20	AC45/4209S	AC45/4219S

Housing	Flush mounting Non flush mounting	L1	L2	L3	L4	L5	Female connector	Body diameter (d)	Max switching frequency (f ₁)	Rated operational current (I _e)	Nominal sensing dist. (S _n) ± 10%	ORDERING REFERENCES	
		mm	mm	mm	mm	mm						n°	mm
M-6	•	-	56	51	-	107	2	M30 x 1,5	20	500	10	AC30/4E09S	AC30/4E19S
M-6	•	15	41	51	-	107	2	M30 x 1,5	20	500	15	AC30/5E09S	AC30/5E19S
M-3	•	-	50	28	-	78	2	M45 x 1,5	20	500	20	AC45/4E09S	AC45/4E19S

ACB SERIES •
Amplified in a.c. 3 wires + earth •
Cable output •

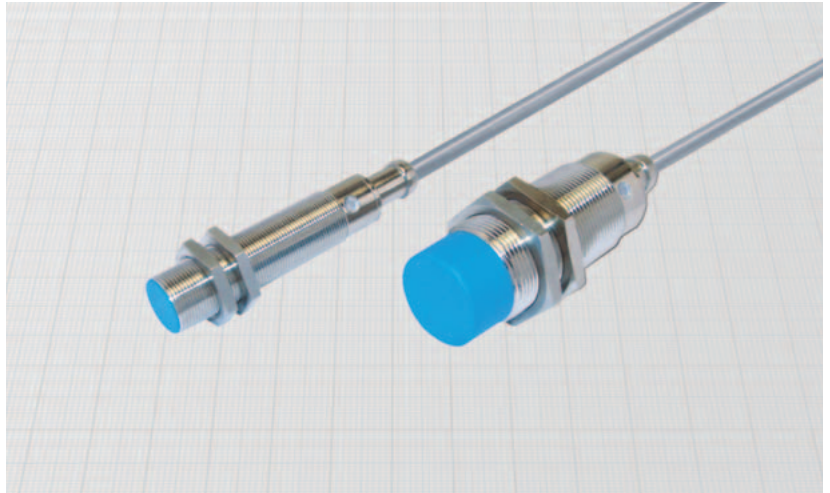
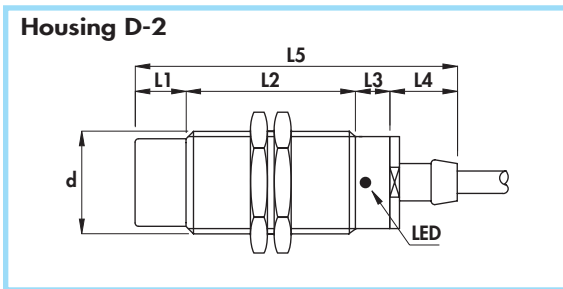
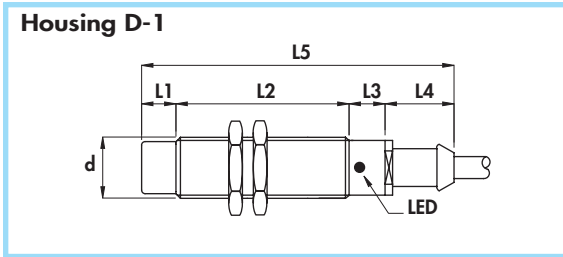

Diameter		M18 x 1	M30 x 1,5
Nut	Size	SW24	SW36
	Thickness mm	4	5
Max tightening torque Nm		35	80

Materials:

- Cable: 2 m PVC
- Housing: nickel plated brass
- Sensing face: plastic

General Features:

These sensors have two wires for power supply and one for the output. They are able to drive very low current loads such as some kind of PLC with A.C. inputs.

Technical data:

- Supply voltage (U_B): 20 ÷ 240 Vac
- Electrical system frequency: 40 ÷ 60 Hz
- No-load supply current (I_o): ≤ 4 mA
- Minimum operational current (I_m): 0,5 mA
- Voltage drop (U_d): ≤ 3 V
- Temperature range: -20° ÷ +70°C
- Max thermal drift of sensing distance S_r : ± 10%
- Repeat accuracy (R): 2%
- Switching hysteresis (H): 10%
- Degree of protection: IP67
- Switch status indicator: yellow LED
- Cable conductor cross section: 0,75 mm²
- Suppression of initial false impulse
- Electromagnetic compatibility (EMC) according to EN60947-5-2 **CE**
- Shock and vibration resistance according to EN60068-2-27 EN60068-2-6

Housing	Flush mounting Non flush mounting	L1	L2	L3	L4	L5	Cable diameter	Body diameter (d)	Max switching frequency (f)	Rated operational current (I _o)	Nominal sensing distance (S _r) ± 10%	ORDERING REFERENCES	
		mm	mm	mm	mm	mm						mm	mm
D - 1	•	-	60	12	20	92	6	M18 x 1	20	250	5	ACB18/4709S	ACB18/4719S
D - 1		10	50	12	20	92	6	M18 x 1	20	250	8	ACB18/5709S	ACB18/5719S
D - 2	•	-	65	10	20	95	6	M30 x 1,5	20	250	10	ACB30/4709S	ACB30/4719S
D - 2	•	15	50	10	20	95	6	M30 x 1,5	20	250	15	ACB30/5709S	ACB30/5719S

CYLINDRICAL INDUCTIVE SENSORS IN PLASTIC HOUSING

- **NAMUR SERIES**
- **Non-amplified in d.c. 2 wires**
- **Cable output**

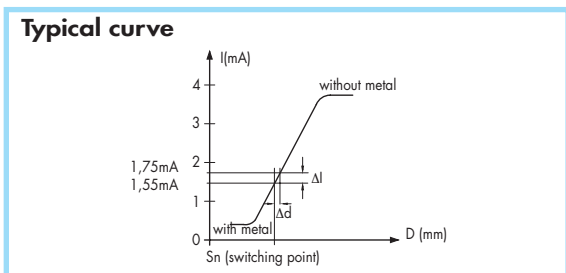
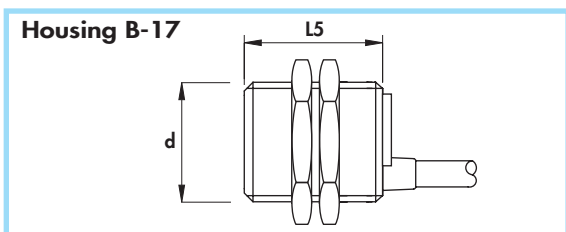
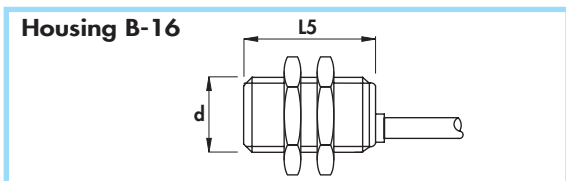
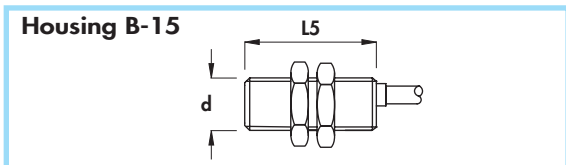
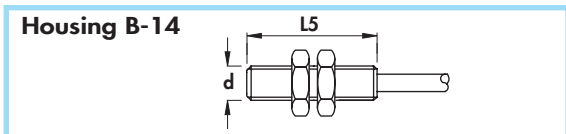

Diameter	M8 x 1	M12 x 1	M18 x 1	M30 x 1,5
Nut	Size SW13	SW17	SW24	SW36
	Thickness mm	4	4	5
Max tightening torque Nm	1	1	5	20

Materials:

- Cable: 2 m PVC CEI 20 - 22 II; 90°C; 300 V; O.R.
- Housing: plastic
- Sensing face: plastic

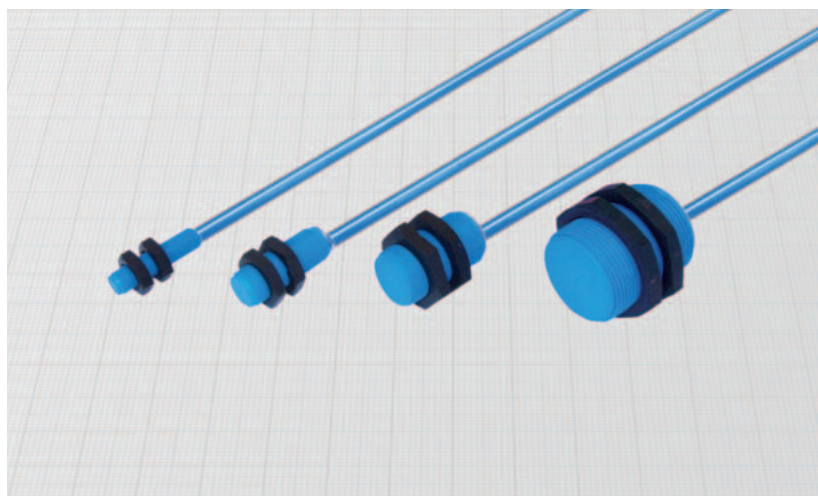

Technical data:

- Working voltage: $5 \div 30$ Vdc
- Supply voltage according to NAMUR: $7,7 \div 9$ Vdc
- Max ripple: 10%
- Consumption at 8,2 V con $R_x = 1000 \Omega$
 - with metal: ≤ 1 mA
 - without metal: ≥ 3 mA
- Temperature range: $-25^\circ \div +70^\circ\text{C}$
- Max thermal drift of sensing distance S_n : $\pm 10\%$
- Repeat accuracy (R): 2%
- Degree of protection: IP67
- Cable conductor cross section:
 - 0,35 mm² on 8 and 12 mm
 - 0,75 mm² on 18 and 30 mm
- According to EN60947-5-6
- Electromagnetic compatibility (EMC) according to EN60947-5-2
- Shock and vibration resistance according to EN60068-2-27 EN60068-2-6
- For certified ATEX version see ATEX Catalogue

Housing	Flush mounting Non flush mounting	L1	L2	L3	L4	L5	Cable diameter	Body diameter (d)	Max switching frequency (f)	Nominal sensing distance (S_n) $\pm 10\%$	ORDERING REFERENCES
		mm	mm	mm	mm	mm					
B-14	•	-	-	-	-	30	4	M8 x 1	5	1,5	DC8P/4600 DC8P/5600
B-14	•	-	-	-	-	30	4	M8 x 1	3	2,5	
B-15	•	-	-	-	-	30	4	M12 x 1	5	2	DC12P/4600 DC12P/5600
B-15	•	-	-	-	-	30	4	M12 x 1	1	4	
B-16	•	-	-	-	-	30	5	M18 x 1	1	5	DC18P/4600 DC18P/5600
B-16	•	-	-	-	-	30	5	M18 x 1	0,5	8	
B-17	•	-	-	-	-	35	5	M30 x 1,5	0,3	10	DC30P/4600 DC30P/5600
B-17	•	-	-	-	-	35	5	M30 x 1,5	0,2	15	

Diameters 8 - 12 - 18 mm •
 Amplified in d.c. 3 and 4 wires •
 Cable output •

Housing B-18

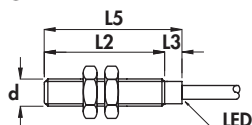

Housing B-19

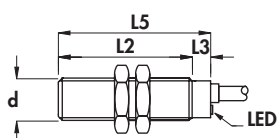

Housing C-1

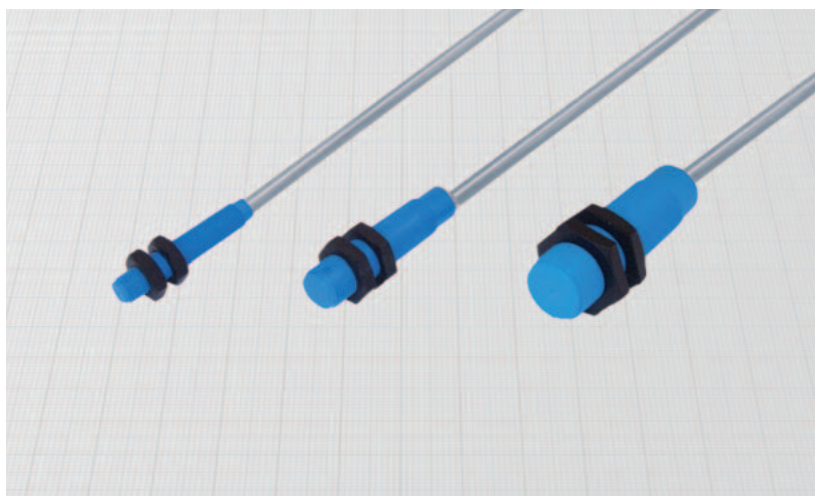
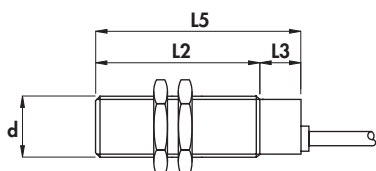

Diameter	M8 x 1	M12 x 1	M18 x 1
Nut	Size	SW13	SW17
	Thickness mm	4	4
Max tightening torque Nm	1	1	5

Materials:

- Cable: 2 m PVC CEI 20 - 22 II; 90°C; 300 V; O.R.
- Housing: plastic
- Sensing face: plastic

Technical data:

- Supply voltage (U_B): see ordering references
- Max ripple: 10%
- No-load supply current (I_0): ≤ 10 mA
- Voltage drop (U_d): on 8 and 12 mm $\leq 1,5$ V
on 18 mm $\leq 2,2$ V
- Temperature range: $-25^\circ \div +70^\circ\text{C}$
- Max thermal drift of sensing distance S_T : $\pm 10\%$
- Repeat accuracy (R): 2%
- Switching hysteresis (H): 10%
- Degree of protection: IP67
- Switch status indicator: yellow LED
- Cable conductor cross section: 0,22 mm² on 8 mm
0,35 mm² on 12 mm
0,50 mm² on 18 mm
- Protected against short-circuit and overload
- Protected against any wrong connection
- Suppression of initial false impulse
- Electromagnetic compatibility (EMC) according to EN60947-5-2
- Shock and vibration resistance according to EN60068-2-27 EN60068-2-6

Housing	Flush mounting Non flush mounting	L2	L3	L5	Cable diameter	Body diameter (d)	Supply di alimentazione (U_B)	Max switching frequency (f)	Rated operational current (I_0)	Nominal sensing distance ($S_n \pm 10\%$)	ORDERING REFERENCES		
											V (min-max)	KHz	mA
B-18	•	40	7	47	3,5	M8 x 1	7÷30	4	200	1,5	DCA8P/4609KS	DCA8P/4619KS	DCA8P/4629KS
B-18	•	40	7	47	3,5	M8 x 1	7÷30	3	200	2,5	DCA8P/5609KS	DCA8P/5619KS	DCA8P/5629KS
B-19	•	42	8	50	4	M12 x 1	5÷40	2	200	2	DCA12P/4609KS	DCA12P/4619KS	DCA12P/4629KS
B-19	•	42	8	50	4	M12 x 1	5÷40	1,5	200	4	DCA12P/5609KS	DCA12P/5619KS	DCA12P/5629KS
C-1	•	50	10	60	5	M18 x 1	5÷60	1	400	5	DCA18P/4609KS	DCA18P/4619KS	DCA18P/4629KS
C-1	•	50	10	60	5	M18 x 1	5÷60	1	400	8	DCA18P/5609KS	DCA18P/5619KS	DCA18P/5629KS
											NPN (negative switching)		
											Use the above mentioned part number changing the last number 9 with 8 (ie. DCA8P/4608KS)		

CYLINDRICAL INDUCTIVE SENSORS IN PLASTIC HOUSING

- Amplified in d.c. 3 or 4 wires
- Diameters 30 - 34 mm
- Cable output

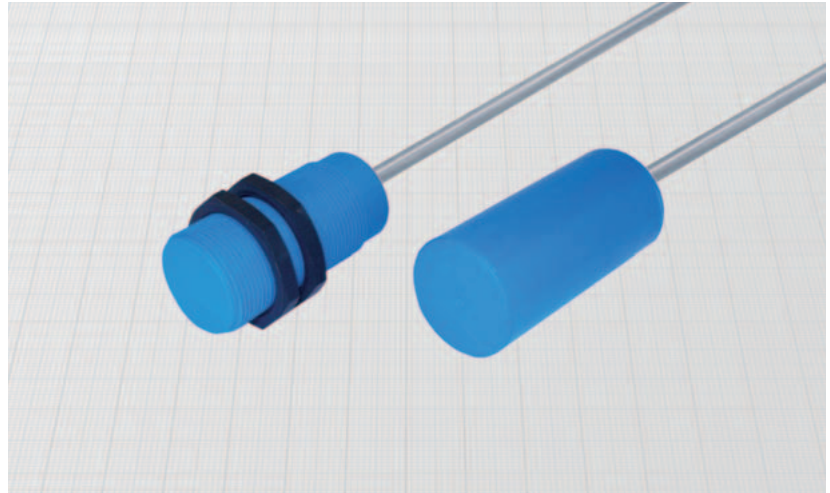
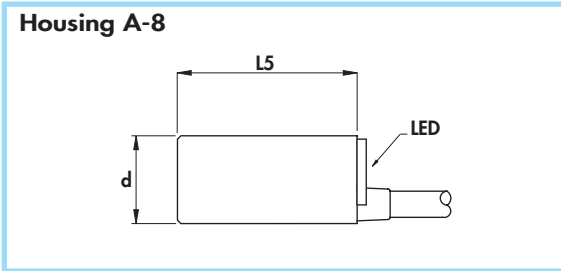
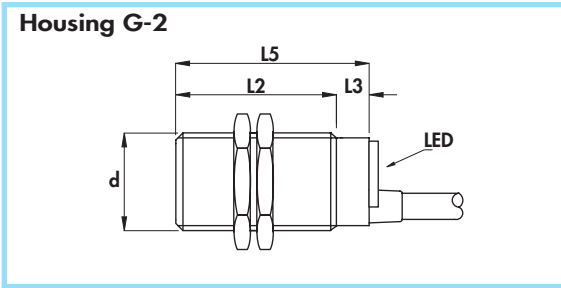

Diameter	M30 x 1,5	
Nut	Size	SW36
	Thickness mm	5
Max tightening torque Nm	20	

Materials:

- Cable: 2 m PVC CEI 20 - 22 II; 90°C; 300 V; O.R.
- Housing: plastic
- Sensing face: plastic

Technical data:

- Supply voltage (U_B): 7 ÷ 60 Vdc
- Max ripple: 10%
- No-load supply current (I_0): ≤ 10 mA
- Voltage drop (U_d): ≤ 2,2 V
- Temperature range: -25° ÷ +70°C
- Max thermal drift of sensing distance S_r : ± 10%
- Repeat accuracy (R): 2%
- Switching hysteresis (H): 10%
- Degree of protection: IP67
- Switch status indicator: yellow LED
- Cable conductor cross section: 0,50 mm²
- Protected against short-circuit and overload
- Protected against any wrong connection
- Suppression of initial false impulse
- Electromagnetic compatibility (EMC) according to EN60947-5-2
- Shock and vibration resistance according to EN60068-2-27 EN60068-2-6

Housing	Flush mounting Non flush mounting	L2	L3	L5	Cable diameter	Body diameter (d)	Max switching frequency (F)	Rated operational current (I_e)	Nominal sensing distance (S_n) ± 10%	ORDERING REFERENCES		
										mm	mm	mm
G-2	•	50	10	60	6	M30 x 1,5	0,8	400	10	PNP (positive switching) NO brown/black/blue NC brown/black/blue NO+NC brown/black/white/blue		
G-2	•	50	10	60	6	M30 x 1,5	0,4	400	15	DCA30P/4609KS DCA30P/5609KS	DCA30P/4619KS DCA30P/5619KS	DCA30P/4629KS DCA30P/5629KS
A-8	•	-	-	70	6	34	0,2	400	20	DCA34P/5609LKS	DCA34P/5619LKS	DCA34P/5629LKS
										NPN (negative switching) Use the above mentioned part number changing the last number 9 with 8 (ie. DCA30P/4608KS)		
										NO brown/black/blue NC brown/black/blue NO+NC brown/black/white/blue		

SHORT SERIES • Amplified in d.c. 3 wires • Cable output •

Housing B-14

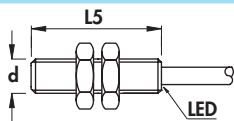

Housing B-15

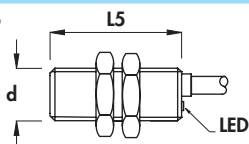

Housing B-16

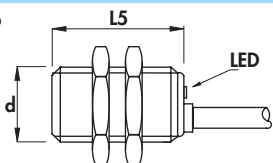

Housing B-17

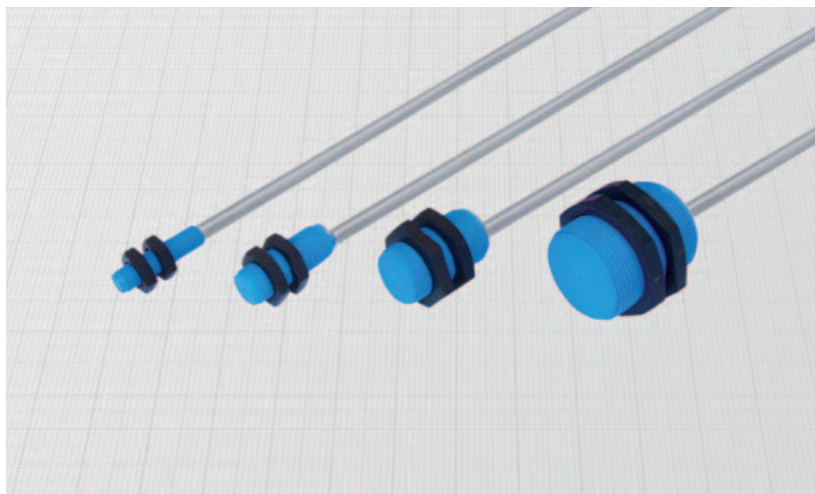
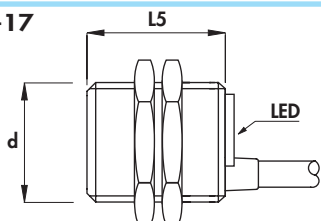

Diameter	M8 x 1	M12 x 1	M18 x 1	M30 x 1,5	
Nut	Size	SW13	SW17	SW24	SW36
	Thickness mm	4	4	4	5
Max tightening torque Nm	1	1	5	20	

Materials:

- Cable: 2 m PVC CEI 20 - 22 II; 90°C; 300 V; O.R.
- Housing: plastic
- Sensing face: plastic

Technical data:

- Supply voltage (U_B): see ordering references
- Max ripple: 10%
- No-load supply current (I_0): ≤ 10 mA
- Voltage drop (U_d): $\leq 1,5$ V
- Temperature range: $-25^\circ \div +70^\circ\text{C}$
- Max thermal drift of sensing distance S_r : $\pm 10\%$
- Repeat accuracy (R): 2%
- Switching hysteresis (H): 10%
- Degree of protection: IP67
- Switch status indicator: yellow LED
- Cable conductor cross section: 0,22 mm² on 8 mm
0,35 mm² on 12 mm
0,50 mm² on 18 and 30 mm

- Protected against short-circuit and overload
- Protected against any wrong connection
- Suppression of initial false impulse
- Electromagnetic compatibility (EMC) according to EN60947-5-2
- Shock and vibration resistance according to EN60068-2-27 EN60068-2-6

Housing	Flush mounting Non flush mounting	L1	L2	L3	L4	L5	Cable diameter	Body diameter (d)	Supply di alimentazione (U_B)	Max switching frequency (f)	Rated operational current (I_e)	Nominal sensing distance (S_n) $\pm 10\%$	ORDERING REFERENCES	
													PNP (positive switching)	
		mm	mm	mm	mm	mm	mm	mm	V (min - max)	KHz	mA	mm		
B-14	•	-	-	-	-	30	3,5	M8 x 1	7 ÷ 30	4	200	1,5	DSA8P/4609KS	DSA8P/4619KS
B-14	•	-	-	-	-	30	3,5	M8 x 1	7 ÷ 30	3	200	2,5	DSA8P/5609KS	DSA8P/5619KS
B-15	•	-	-	-	-	30	4	M12 x 1	7 ÷ 30	2	200	2	DSA12P/4609KS	DSA12P/4619KS
B-15	•	-	-	-	-	30	4	M12 x 1	7 ÷ 30	1,5	200	4	DSA12P/5609KS	DSA12P/5619KS
B-16	•	-	-	-	-	30	5	M18 x 1	5 ÷ 40	0,8	200	5	DSA18P/4609KS	DSA18P/4619KS
B-16	•	-	-	-	-	30	5	M18 x 1	5 ÷ 40	0,6	200	8	DSA18P/5609KS	DSA18P/5619KS
B-17	•	-	-	-	-	35	6	M30 x 1,5	7 ÷ 40	0,8	200	10	DSA30P/4609KS	DSA30P/4619KS
B-17	•	-	-	-	-	35	6	M30 x 1,5	7 ÷ 40	0,4	200	15	DSA30P/5609KS	DSA30P/5619KS
													NPN (negative switching)	
Use the above mentioned part number changing the last number 9 with 8 (ie. DSA8P/4608KS)														
		mm	mm	mm	mm	mm	mm	mm	V (min - max)	KHz	mA	mm		

CYLINDRICAL INDUCTIVE SENSORS IN PLASTIC HOUSING

- Degree of protection IP68
- Amplified in d.c. 3 and 4 wires
- Cable output

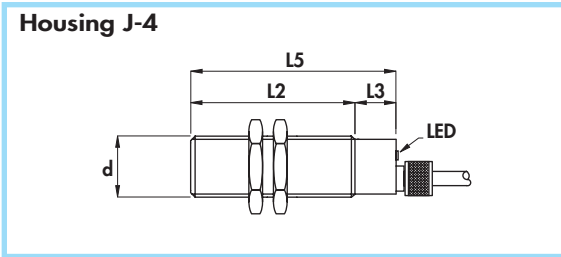

Diameter	M18 x 1	
Nut	Size	SW24
	Thickness mm	4
Max tightening torque Nm	5	

Materials:

- Cable: 2 m PVC CEI 20 - 22 II; 90°C; 300 V; O.R.
- Housing: plastic
- Gland: nickel plated brass
- Sensing face: plastic

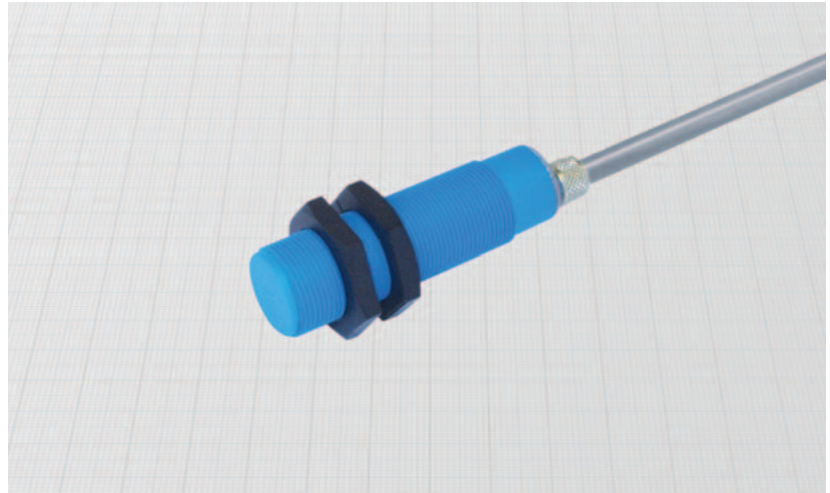

General Features:

This new series solves definitively the problem of the ingress of liquids to the inner parts of the sensors. Thanks to the inner hermetic sealing they can be submitted to no-stop jets of liquids under pressure even in presence of temperature changes. They find application in automatic washing machinery, in machines subject to water jets and in continuous immersion applications.

Technical data:

- Supply voltage (U_B): 5 ÷ 60 Vdc
- Max ripple: 10%
- No-load supply current (I_0): ≤ 10 mA
- Voltage drop (U_d): 2,2 V
- Temperature range: - 25° ÷ + 70°C
- Max thermal drift of sensing distance S_s : ± 10%
- Repeat accuracy (R): 2%
- Switching hysteresis (H): 10%
- Degree of protection: IP68
- Switch status indicator: yellow LED
- Cable conductor cross section: 0,50 mm²
- Protected against short-circuit and overload
- Protected against any wrong connection
- Suppression of initial false impulse
- Electromagnetic compatibility (EMC) according to EN60947-5-2
- Shock and vibration resistance according to EN60068-2-27 EN60068-2-6

Housing	Flush mounting Non flush mounting	L2	L3	L5	Cable diameter	Body diameter (d)	Max switching frequency (f)	Rated operational current (I _o)	Nominal sensing distance (S _n) ± 10%	ORDERING REFERENCES		
										PNP (positive switching)		
										NO	NC	NO + NC
J-4	•	50	10	60	5	M18 x 1	1	400	5	DCA18P/4609KSJ	DCA18P/4619KSJ	DCA18P/4629KSJ
J-4	•	50	10	60	5	M18 x 1	1	400	8	DCA18P/5609KSJ	DCA18P/5619KSJ	DCA18P/5629KSJ
										NPN (negative switching)		
										Use the above mentioned part number changing the last number 9 with 8 (ie. DCA18P/4608KSJ)		
										NO	NC	NO + NC

Amplified in a.c. 2 wires •

Cable output •

Housing B-18

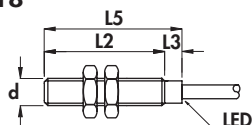

Housing B-19

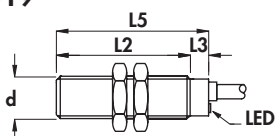

Housing C-1

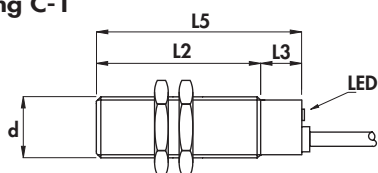

Housing G-2

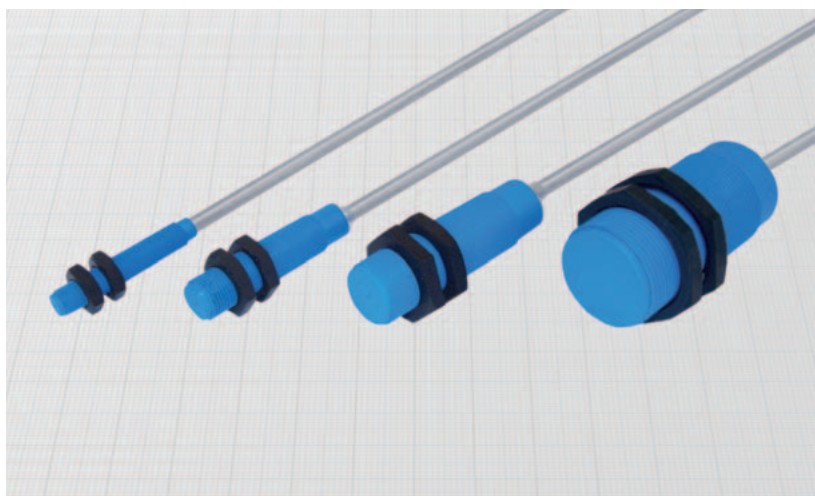
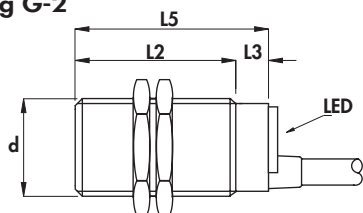

Diameter		M8 x 1	M12 x 1	M18 x 1	M30 x 1,5
Nut	Size	SW13	SW17	SW24	SW36
	Thickness mm	4	4	4	5
Max tightening torque Nm		1	1	5	20

Materials:

- Cable: 2 m PVC CEI 20 - 22 II; 90°C; 300 V; O.R.
- Housing: plastic
- Sensing face: plastic

Technical data:

- Supply voltage (U_B): 20 ÷ 240 Vac
- Electrical system frequency: 40 ÷ 60 Hz
- Off-state current (I_o): ≤ 1,5 mA at 110 Vac
- Minimum operational current (I_m): 5 mA
- Voltage drop (U_d): ≤ 5 V
- Temperature range: -25° ÷ +70°C
- Max thermal drift of sensing distance S_r : ± 10%
- Repeat accuracy (R): 2%
- Switching hysteresis (H): 10%
- Degree of protection: IP67
- Switch status indicator: yellow LED
- Cable conductor cross section: 0,35 mm² on 8 and 12 mm
0,50 mm² on 18 mm
0,75 mm² on 30 mm
- Suppression of initial false impulse
- Class 2 equipment according to IEC 536
- Shock and vibration according to EN60068-2-27 EN60068-2-6
- Electromagnetic compatibility (EMC) according to EN60947-5-2

Housing	Flush mounting Non flush mounting	L1	L2	L3	L4	L5	Cable diameter	Body diameter (d)	Max switching frequency (f)	Rated operational current (I _o)	Nominal sensing distance (S _r) ± 10%	ORDERING REFERENCES	
												mm	mm
B-18	•	-	40	7	-	47	4	M8 x 1	25	100	1,5	AC8P/4609S	AC8P/4619S
B-18	•	-	40	7	-	47	4	M8 x 1	25	100	2,5	AC8P/5609S	AC8P/5619S
B-19	•	-	42	8	-	50	4	M12 x 1	25	500	2	AC12P/4609S	AC12P/4619S
B-19	•	-	42	8	-	50	4	M12 x 1	25	500	4	AC12P/5609S	AC12P/5619S
C-1	•	-	50	10	-	60	5	M18 x 1	25	500	5	AC18P/4609S	AC18P/4619S
C-1	•	-	50	10	-	60	5	M18 x 1	25	500	8	AC18P/5609S	AC18P/5619S
G-2	•	-	50	10	-	60	6	M30 x 1,5	25	500	10	AC30P/4609S	AC30P/4619S
G-2	•	-	50	10	-	60	6	M30 x 1,5	25	500	15	AC30P/5609S	AC30P/5619S

CYLINDRICAL INDUCTIVE SENSORS IN PLASTIC HOUSING

- Degree of protection IP68
- Amplified in a.c. 2 wires
- Cable output

Housing J-4

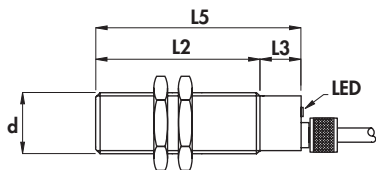

Diameter	M18 x 1	
Nut	Size	SW24
	Thickness mm	4
Max tightening torque Nm	5	

Materials:

- Cable: 2 m PVC CEI 20 - 22 II; 90°C; 300 V; O.R.
- Housing: plastic
- Gland: nickel plated brass
- Sensing face: plastic

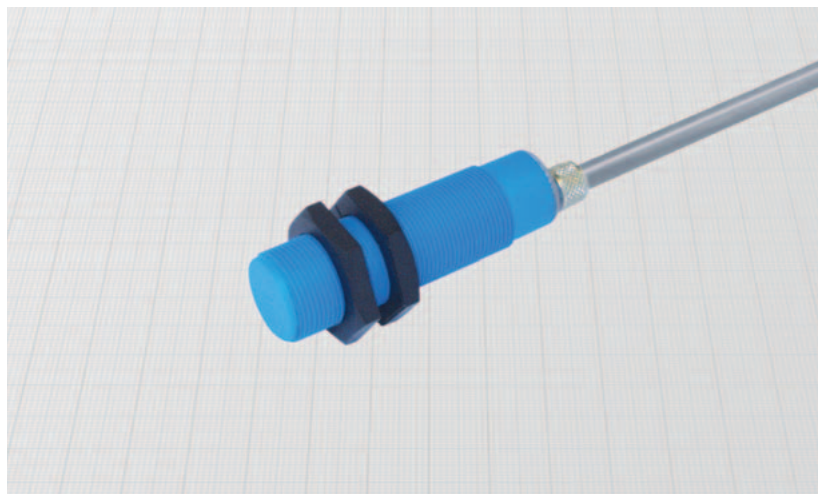

General Features:

This new series solves definitively the problem of the ingress of liquids to the inner parts of the sensors. Thanks to the inner hermetic sealing they can be submitted to no-stop jets of liquids under pressure even in presence of temperature changes. They find application in automatic washing machinery, in machines subject to water jets and in continuous immersion applications.

Technical data:

- Supply voltage (U_B): 20 ÷ 240 Vac
- Electrical system frequency: 40 ÷ 60 Hz
- Off-state current (I_o): ≤ 1,5 mA at 110 Vac
- Minimum operational current (I_m): 5 mA
- Voltage drop (U_d): ≤ 5 V
- Temperature range: -25° ÷ +70°C
- Max thermal drift of sensing distance S_p : ± 10%
- Repeat accuracy (R): 2%
- Switching hysteresis (H): 10%
- Degree of protection: IP68
- Switch status indicator: yellow LED
- Cable conductor cross section: 0,50 mm²
- Suppression of initial false impulse
- Class 2 equipment according to IEC 536
- Shock and vibration according to EN60068-2-27 EN60068-2-6
- Electromagnetic compatibility (EMC) according to EN60947-5-2

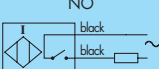
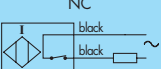
Housing	Flush mounting Non flush mounting	L1	L2	L3	L4	L5	Cable diameter	Body diameter (d)	Max switching frequency (f)	Rated operational current (I _e)	Nominal sensing distance (S _n) ± 10%	ORDERING REFERENCES	
		mm	mm	mm	mm	mm						mm	mm
J-4	•	-	50	10	-	60	5	M18 x 1	25	500	5	 NO black black	 NC black black
J-4	•	-	50	10	-	60	5	M18 x 1	25	500	8	AC18P/4609SJ	AC18P/4619SJ
												AC18P/5609SJ	AC18P/5619SJ

NAMUR SERIES - Type Z •
Non-amplified in d.c. 2 wires •
 Cable output •

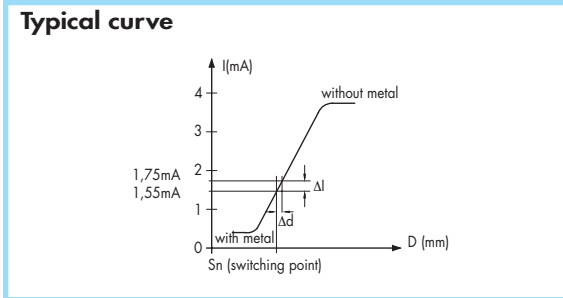
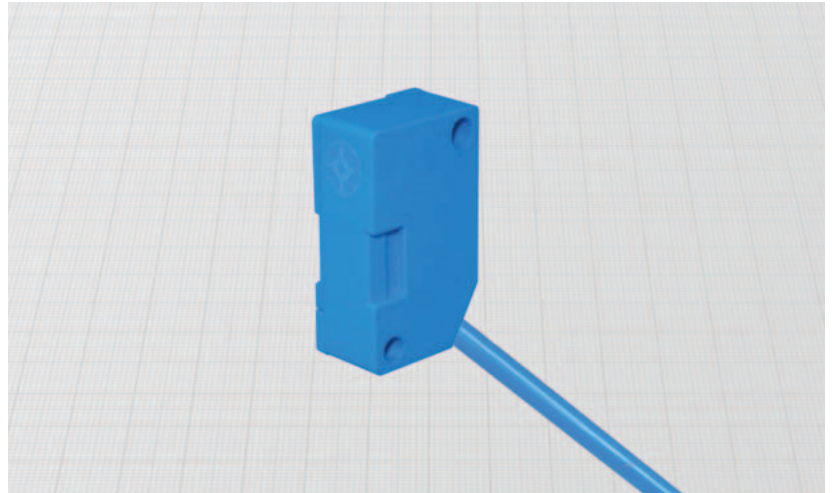
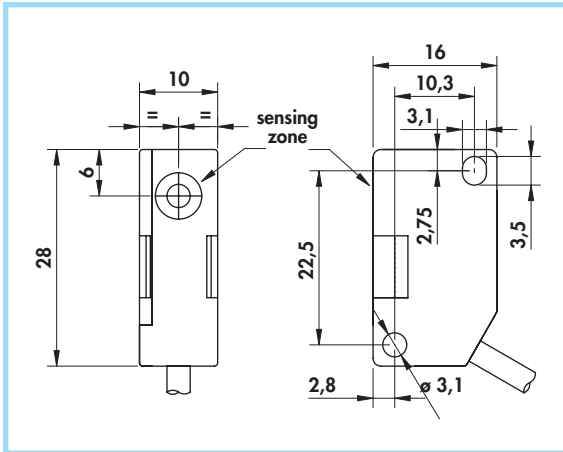

Materials:

- Cable: 2 m PVC CEI 20 - 22 II; 90°C; 300 V; O.R.
- Housing: plastic

General Features:

This sensor has the same shape and fixing holes as V3 standard microswitches. The particular cable position allows the mounting on every side of the housing.

Technical data:

- Working voltage: $5 \div 30$ Vdc
- Supply voltage according to NAMUR: $7,7 \div 9$ Vdc
- Max ripple: 10%
- Consumption at 8,2 V con $R_x = 1000 \Omega$
 - with metal: ≤ 1 mA
 - without metal: ≥ 3 mA
- Temperature range: $-25^\circ \div +70^\circ\text{C}$
- Max thermal drift of sensing distance S_r : $\pm 10\%$
- Repeat accuracy (R): 2%
- Degree of protection: IP67
- Cable conductor cross section: $0,15 \text{ mm}^2$
- According to EN 60947-5-6
- Electromagnetic compatibility (EMC) according to EN60947-5-2
- Shock and vibration resistance according to EN60068-2-27 EN60068-2-6
- For certified ATEX versions see ATEX Catalogue

Flush mounting Non flush mounting	Cable diameter	Sensing zone diameter	Max switching frequency (f)	Nominal sensing distance (S_n) $\pm 10\%$	ORDERING REFERENCES
	mm	mm	KHz	mm	
•	3	9	2	2	DCZ/4600
•	3	9	1	4	DCZ/5600

Type Z •
Amplified in d.c. 2 wires non polarized •
Cable output •

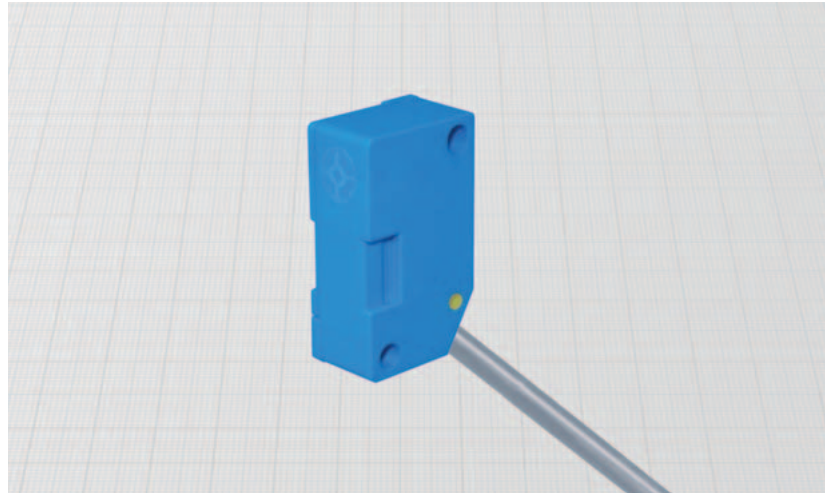
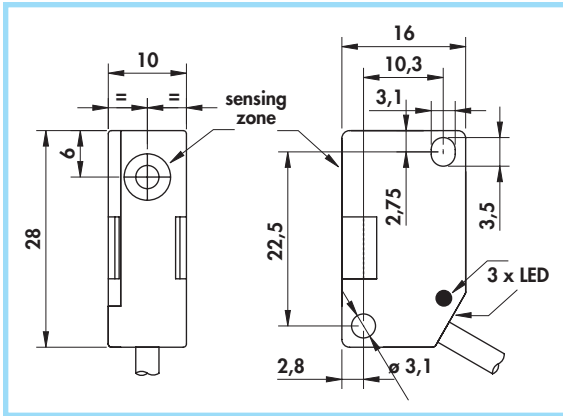

Materials:

- Cable: 2 m PVC CEI 20 - 22 II; 90°C; 300 V; O.R.
- Housing: plastic

General Features:

These sensors are not polarized and the load can be connected on both positive and negative lead (function PNP or NPN). So they can replace traditional mechanical microswitches in many applications. They have shape and fixing holes as V3 standard microswitches. The particular cable position allows the mounting on every side of the housing. The output status is indicated by LED visible from 3 sides.

Technical data:

- Supply voltage (U_B): 10 ÷ 48 Vdc
- Max ripple: 10%
- Off-state current (I_o): ≤ 1 mA
- Minimum operational current (I_m): 5 mA
- Voltage drop (U_d) con $I_e = 10$ mA: ≤ 5 V
- Voltage drop (U_d) con $I_e = 100$ mA: ≤ 6 V
- Temperature range: -25° ÷ +70°C
- Max thermal drift of sensing distance S_r : ± 10%
- Repeat accuracy (R): 2%
- Switching hysteresis (H): 10%
- Degree of protection: IP67
- Switch status indicator: yellow LED
- Cable conductor cross section: 0,35 mm²
- Protected against short-circuit and overload
- Suppression of initial false impulse
- Electromagnetic compatibility (EMC) according to EN60947-5-2
- Shock and vibration resistance according to EN60068-2-27 EN60068-2-6

Flush mounting Non flush mounting	Cable diameter	Sensing zone diameter	Rated operational current (I_e)	Max switching frequency (f)	Nominal sensing distance (S_n) ± 10%	ORDERING REFERENCES	
	mm	mm	mA	KHz	mm		
•	4	9	100	2	2	DCMZ/4600KS	DCMZ/4610KS
•	4	9	100	1,5	4	DCMZ/5600KS	DCMZ/5610KS

RECTANGULAR INDUCTIVE SENSORS

- **NAMUR SERIES - Type T**
- **Non-amplified in d.c. 2 wires**
- **Cable output**

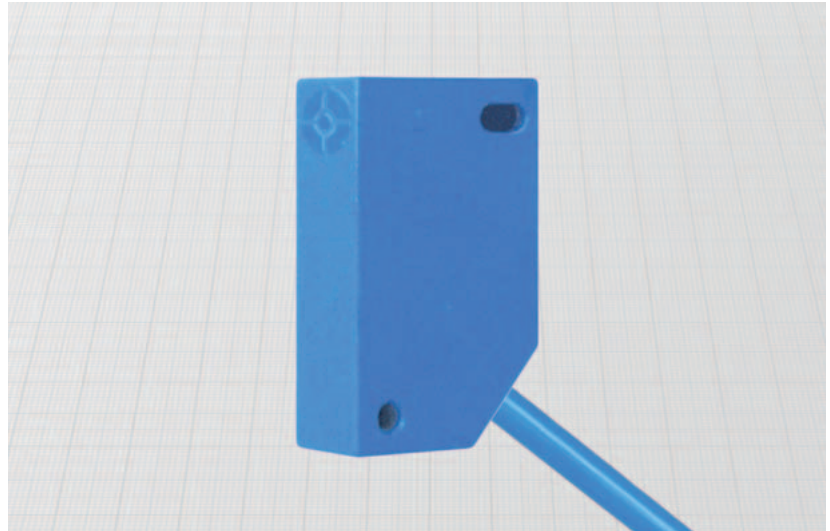
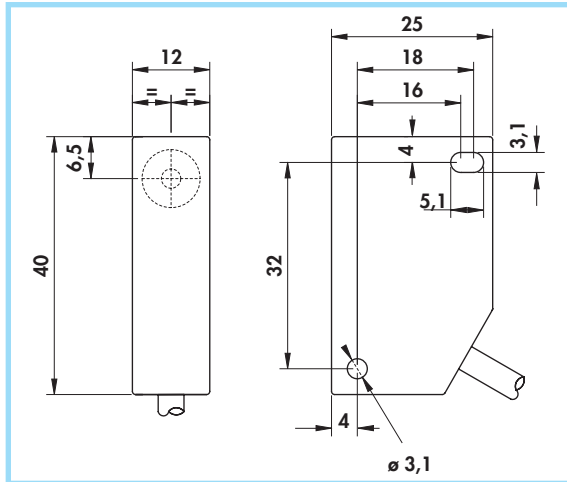

Typical curve

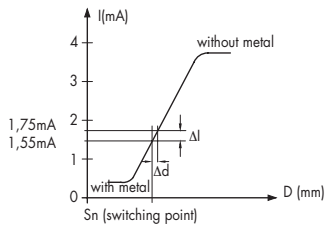

Materials:

- Cable: 2 m PVC CEI 20 - 22 II; 90°C; 300 V; O.R.
- Housing: plastic

Technical data:

- Working voltage: $5 \div 30$ Vdc
- Supply voltage according to NAMUR: $7,7 \div 9$ Vdc
- Max ripple: 10%
- Consumption at 8,2 V with $R_x = 1000 \Omega$
 - with metal: ≤ 1 mA
 - without metal: ≥ 3 mA
- Temperature range: $-25^\circ \div +70^\circ\text{C}$
- Max thermal drift of sensing distance S_n : $\pm 10\%$
- Repeat accuracy (R): 2%
- Degree of protection: IP67
- Cable conductor cross section: $0,35 \text{ mm}^2$
- According to EN60947-5-6
- Electromagnetic compatibility (EMC) according to EN60947-5-2 
- Shock and vibration resistance according to EN60068-2-27 EN60068-2-6
- For certified ATEX version see ATEX Catalogue

Flush mounting Non flush mounting	Cable diameter	Sensing zone diameter	Max switching frequency (f)	Nominal sensing distance (S_n) $\pm 10\%$	ORDERING REFERENCES 
	mm	mm	KHz	mm	
•	4	9	1	2	DCT/4700
•	4	9	0,8	4	DCT/5700

Type T •
Amplified in d.c. 3 and 4 wires •
Cable output •

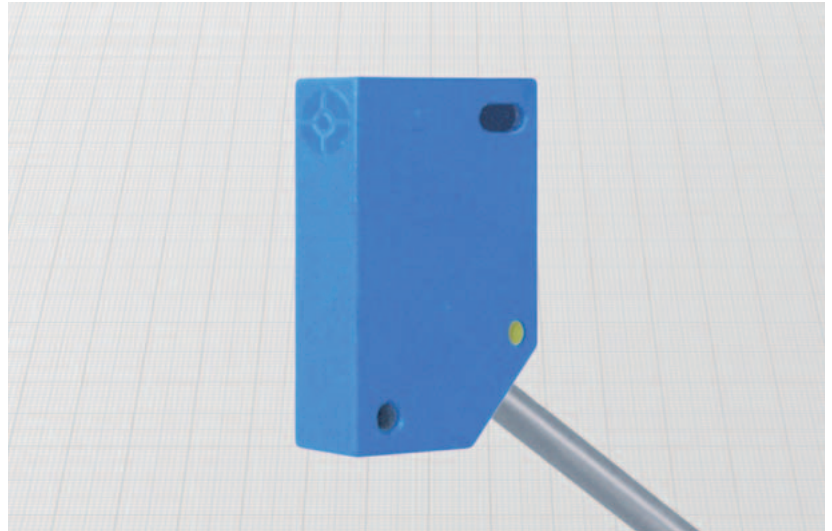
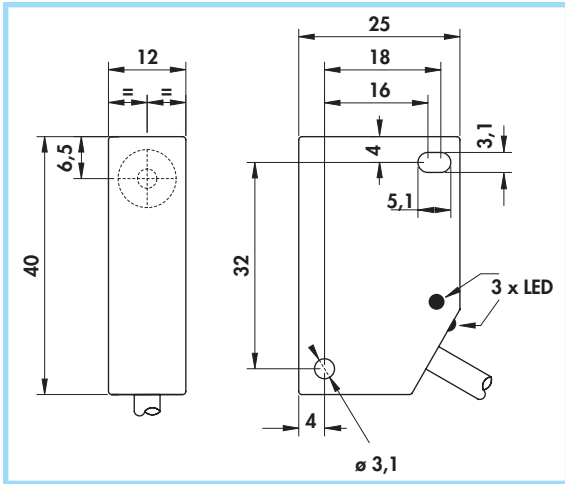

Materials:

- Cable: 2 m PVC CEI 20 - 22 II; 90°C; 300 V; O.R.
- Housing: plastic

Technical data:

- Supply voltage (U_B): 5 ÷ 40 Vdc
- Max ripple: 10%
- No-load supply current (I_0): ≤ 10 mA
- Voltage drop (U_d): ≤ 1,5 V
- Temperature range: -25° ÷ +75°C
- Max thermal drift of sensing distance S_r : ± 10%
- Repeat accuracy (R): 2%
- Switching hysteresis (H): 10%
- Degree of protection: IP67
- Switch status indicator: yellow LED
- Cable conductor cross section: 0,25 mm² on 4 wires versions
0,35 mm² on 3 wires versions
- Protected against short-circuit and overload
- Protected against any wrong connection
- Suppression of initial false impulse
- Electromagnetic compatibility (EMC) according to EN60947-5-2
- Shock and vibration resistance according to EN60068-2-27 EN60068-2-6

Montaggio a filo Montaggio sporgente	Cable diameter mm	Sensing pzone diameter mm	Max switching frequency (f) KHz	Rated operational current (I _e) mA	Nominal sensing distance (S _n) ± 10% mm	ORDERING REFERENCES		
						PNP (positive switching)		
•	4	9	1	200	2			
						DCAT/4709KS	DCAT/4719KS	DCAT/4729KS
•	4	9	0,8	200	4	DCAT/5709KS	DCAT/5719KS	DCAT/5729KS
						NPN (negative switching)		
						Use the above mentioned part number changing the last number 9 with 8 (ie. DCAT/4708KS)		

RECTANGULAR INDUCTIVE SENSORS

- **Type T**
- **Amplified in a.c. 2 wires**
- Cable output

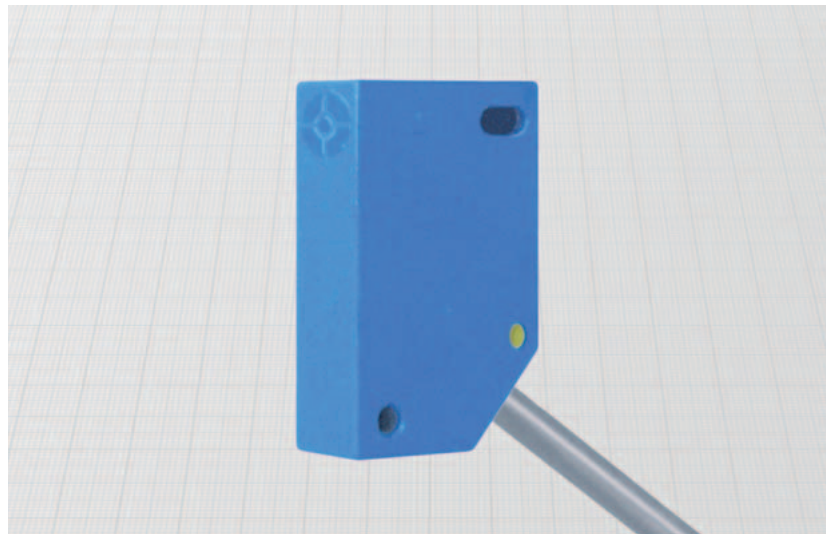
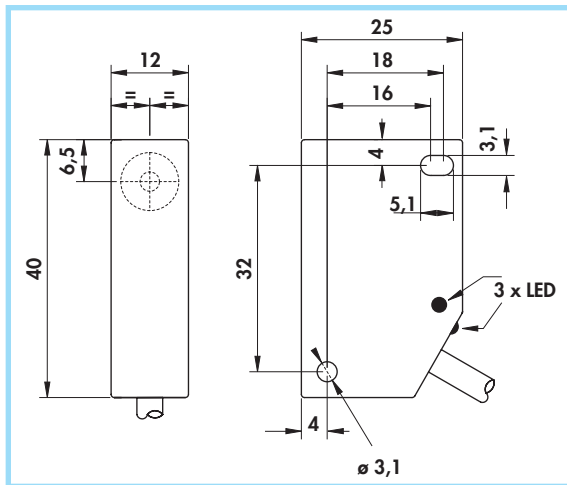

Materials:

- Cable: 2 m PVC CEI 20 - 22 II; 90°C; 300 V; O.R.
- Housing: plastic

Technical data:

- Supply voltage (U_B): 20 ÷ 240 Vac
- Electrical system frequency: 40 ÷ 60 Hz
- Off-state current (I_o): ≤ 1,5 mA a 110 Vac
- Minimum operational current (I_m): 5 mA
- Voltage drop (U_d): ≤ 5 V
- Temperature range: - 25° ÷ + 70°C
- Max thermal drift of sensing distance S_s : ± 10%
- Repeat accuracy (R): 2%
- Switching hysteresis (H): 10%
- Degree of protection: IP67
- Switch status indicator: yellow LED
- Cable conductor cross section: 0,35 mm²
- Suppression of initial false impulse
- Class 2 equipment according to IEC 536
- Shock and vibration according to EN60068-2-27 EN60068-2-6
- Electromagnetic compatibility (EMC) according to EN60947-5-2

Flush mounting Non flush mounting	Cable diameter	Sensing pzone diameter	Max switching frequency (f)	Rated operational current (I_e)	Nominal sensing distance (S_n) ± 10%	ORDERING REFERENCES	
	mm	mm	Hz	mA	mm	NO 	NC
•	4	9	25	500	2	ACT/4709S	ACT/4719S
•	4	9	25	500	4	ACT/5709S	ACT/5719S

NAMUR SERIES - Type X and Y •
Non-amplified in d.c. 2 wires •
Cable output •

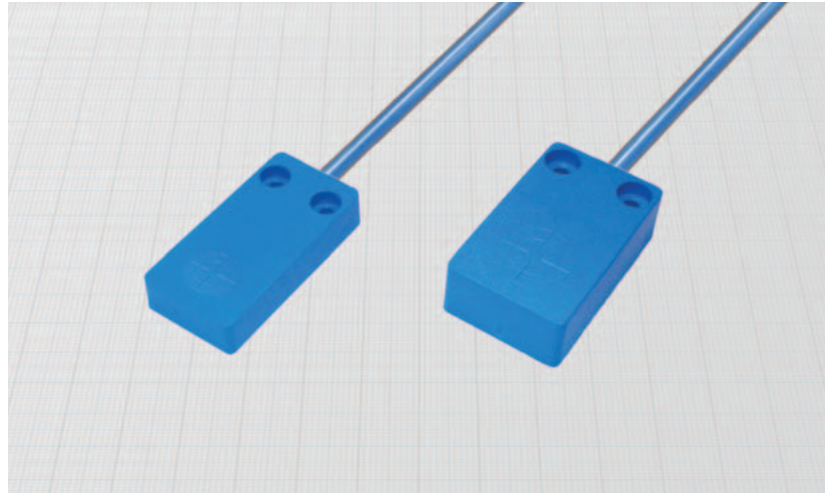
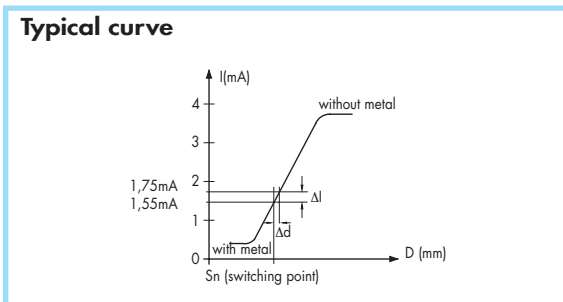
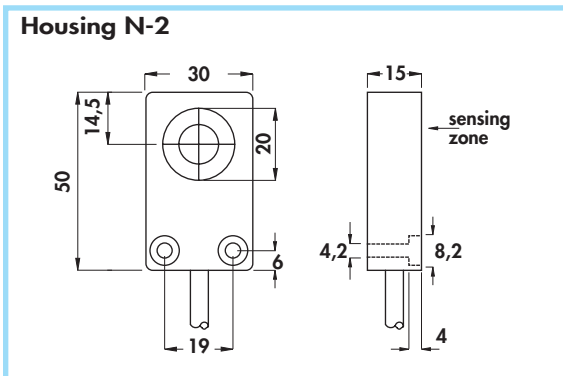
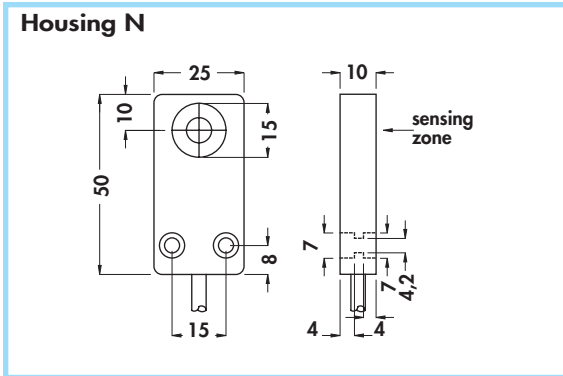

Materials:

- Cable: 2m PVC - CEI 2022 II- 90°C 300V.O.R.
- Housing: plastic

Technical data:

- Working voltage: $5 \div 30$ Vdc
- Supply voltage according to NAMUR: $7,7 \div 9$ Vdc
- Max ripple: 10%
- Consumption at 8,2 V con $R_x = 1000 \Omega$
 - with metal: ≤ 1 mA
 - without metal: ≥ 3 mA
- Temperature range: $-25^\circ \div +70^\circ$ C
- Max thermal drift of sensing distance S_r : $\pm 10\%$
- Repeat accuracy (R): 2%
- Degree of protection: IP67
- Cable conductor cross section: $0,75 \text{ mm}^2$
- According to EN60947-5-6
- Electromagnetic compatibility (EMC) according to EN60947-5-2
- Shock and vibration resistance according to EN60068-2-27 EN60068-2-6
- For certified ATEX version see ATEX Catalogue

Housing	Montaggio a filo	Montaggio sporgente	Cable diameter	Sensing zone diameter	Max switching frequency (f)	Nominal sensing distance (S _n) ± 10%	ORDERING REFERENCES
			mm	mm	KHz	mm	
Z	•	•	5	15	2	5	DCX/4700 DCX/5700
			5	15	1	8	
N-2	•	•	5	23	0,8	10	DCY/4700 DCY/5700
			5	23	0,4	15	

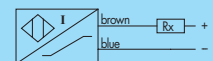

RECTANGULAR INDUCTIVE SENSORS

- Type X and Y
- Amplified in d.c. 3 and 4 wires
- Cable and connector output M8 x 1

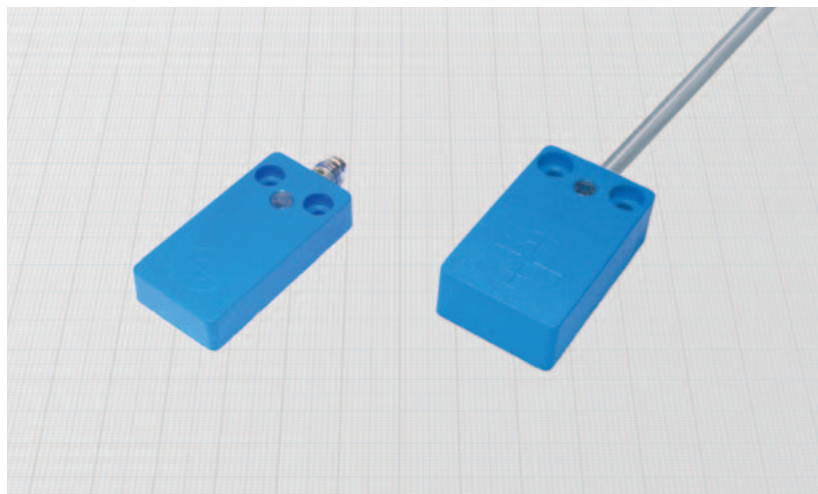
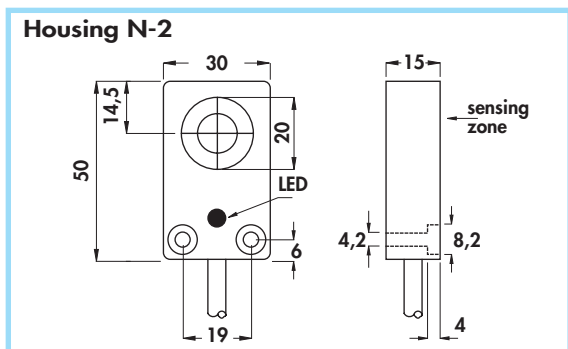
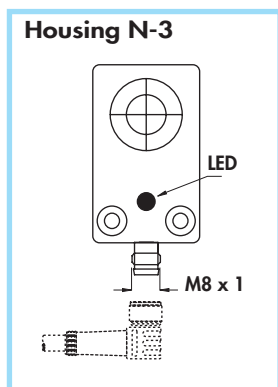
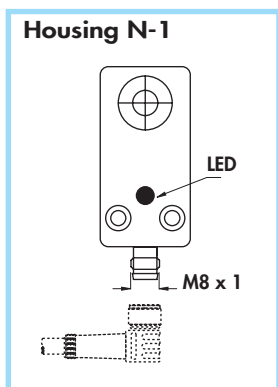
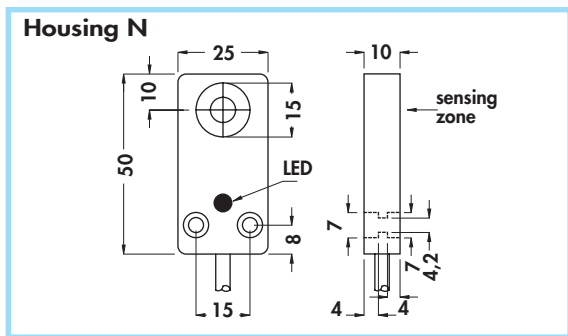

Technical data:

- Supply voltage (U_b): $5 \div 60$ Vdc
- Max ripple: 10%
- No-load supply current (I_0): ≤ 10 mA
- Voltage drop (U_d): $\leq 2,2$ V
- Temperature range: $-25^\circ \div +75^\circ$ C
- Max thermal drift of sensing distance S_r : $\pm 10\%$
- Repeat accuracy (R): 2%
- Switching hysteresis (H): 10%
- Degree of protection: IP67
- Switch status indicator: yellow LED
- Cable conductor cross section (cable version): $0,50$ mm²
- Protected against short-circuit and overload
- Protected against any wrong connection
- Suppression of initial false impulse
- Electromagnetic compatibility (EMC) according to EN60947-5-2
- Shock and vibration resistance according to EN60068-2-27 EN60068-2-6

Materials:

- Cable: 2 m PVC CEI 20 - 22 II; 90°C; 300 V; O.R.
- Housing: plastic
- Connector: nickel plated brass

Housing	Flush mounting Non flush mounting	Cable diameter mm	Female connector n°	Sensing zone diameter mm	Max switching frequency kHz	Rated operational current (I_e) mA	Nominal sensing distance (S_n) $\pm 10\%$ mm	ORDERING REFERENCES		
								PNP (positive switching)		
								NO	NC	NO + NC
N	•	5	-	15	1	400	5	DCAX/4609KS	DCAX/4619KS	DCAX/4629KS
N	•	5	-	15	1	400	8	DCAX/5609KS	DCAX/5619KS	DCAX/5629KS
N-1	•	-	11-12	15	1	400	5	DCAX/4909KS	DCAX/4919KS	DCAX/4929KS
N-1	•	-	11-12	15	1	400	8	DCAX/5909KS	DCAX/5919KS	DCAX/5929KS
N-2	•	5	-	23	0,8	400	10	DCAY/4609KS	DCAY/4619KS	DCAY/4629KS
N-2	•	5	-	23	0,4	400	15	DCAY/5609KS	DCAY/5619KS	DCAY/5629KS
N-3	•	-	11-12	23	0,8	400	10	DCAY/4909KS	DCAY/4919KS	DCAY/4929KS
N-3	•	-	11-12	23	0,4	400	15	DCAY/5909KS	DCAY/5919KS	DCAY/5929KS

NPN (negative switching)

Use the above mentioned part number changing the last number 9 with 8 (ie. DCAX/4608KS)

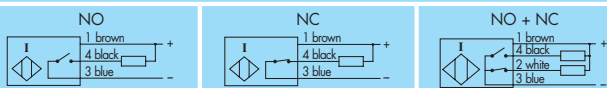

Type X and Y •
 Amplified in a.c. 2 wires •
 Cable output •

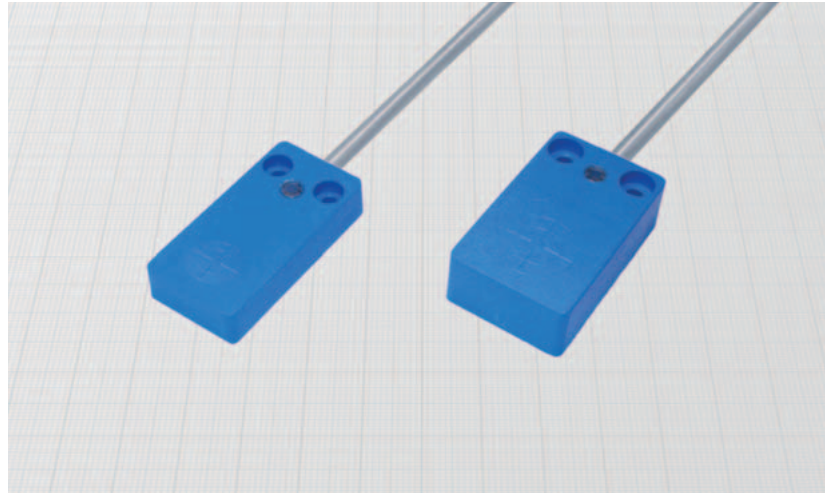
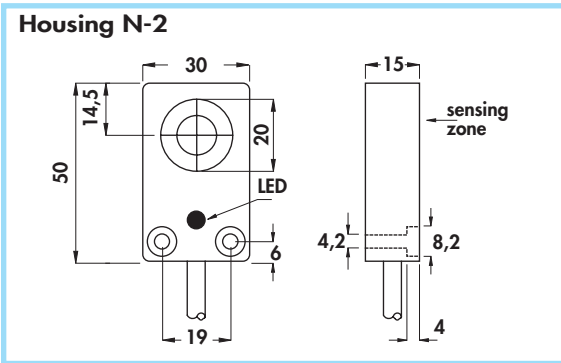
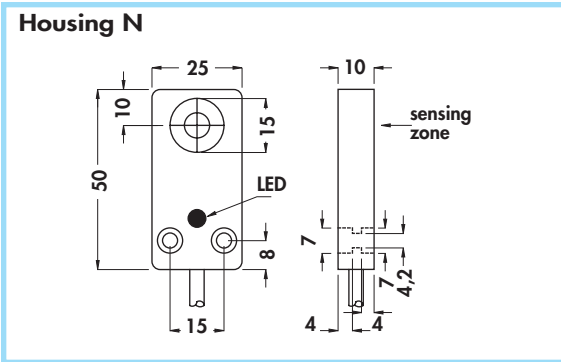

Materials:

- Cable: 2 m PVC CEI 20 - 22 II; 90°C; 300 V; O.R.
- Housing: plastic

Technical data:

- Supply voltage (U_B): 20 ÷ 240 Vac
- Electrical system frequency: 40 ÷ 60 Hz
- Off-state current (I_f): ≤ 1,5 mA a 110 Vac
- Minimum operational current (I_m): 5 mA
- Voltage drop (U_d): ≤ 5 V
- Temperature range: -25° ÷ +70°C
- Max thermal drift of sensing distance S_r : ± 10%
- Repeat accuracy (R): 2%
- Switching hysteresis (H): 10%
- Degree of protection: IP67
- Switch status indicator: yellow LED
- Cable conductor cross section: 0,50 mm²
- Suppression of initial false impulse
- Class 2 equipment according to IEC 536
- Shock and vibration according to EN60068-2-27 EN60068-2-6
- Electromagnetic compatibility (EMC) according to EN60947-5-2

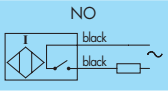
Housing	Flush mounting Non flush mounting	Cable diameter	Sensing zone diameter	Max switching frequency (f)	Rated operational current (I_e)	Nominal sensing distance (S_n) ± 10%	ORDERING REFERENCES	
							NO	NC
Z	• •	5	15	20	500	5	 ACX/4609S ACX/5609S	 ACX/4619S ACX/5619S
		5	15	20	500	8		
N-2	• •	5	23	20	500	10	ACY/4609S ACY/5609S	ACY/4619S ACY/5619S
		5	23	20	500	15		

RECTANGULAR INDUCTIVE SENSORS

- **NAMUR SERIES - Type P - 5 Positions head**
- **Non-amplified in d.c.**
- **Terminal block output**

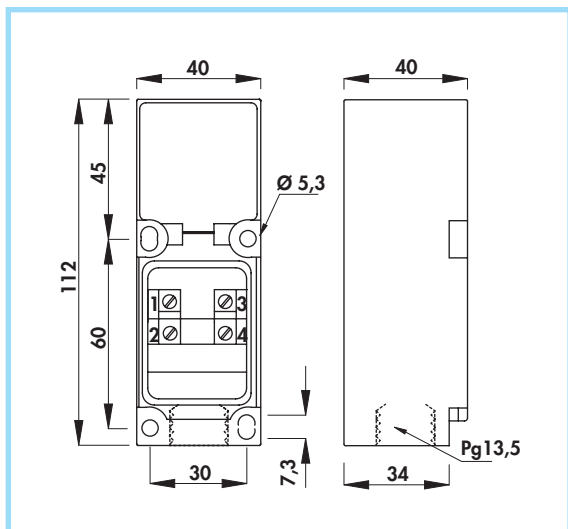

Connection diagram

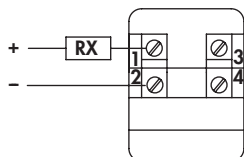

Typical curve

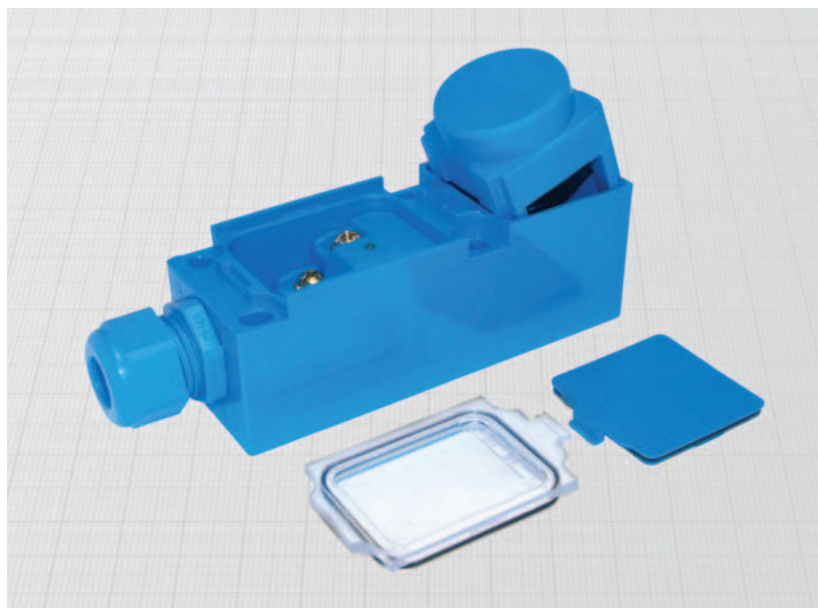
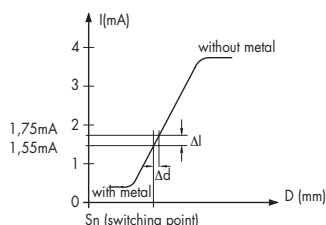

General Features:

These sensors are called "turnable sensing head" because the sensing head, inside the plastic housing can be positioned on 5 different positions. To choose the desired sensing face it is enough to remove the cover and set the sensing head in the proper position.

The internal terminal block can be easily reached by removing the transparent cover. The included plastic gland Pg13.5 is suited for cables diameter up to 9 mm.

Materials:

- Housing: plastic
- Terminal block cover: polycarbonate

Technical data:

- Working voltage: 5 ÷ 30 Vdc
- Supply voltage according to NAMUR: 7,7 ÷ 9 Vdc
- Max ripple: 10%
- Consumption at 8,2 V con Rx = 1000 Ω
 - with metal: ≤ 1 mA
 - without metal: ≥ 3 mA
- Temperature range: - 25° ÷ + 70°C
- Max thermal drift of sensing distance S_T: ± 10%
- Repeat accuracy (R): 4%
- Degree of protection (with fully locked gland): IP65
- According to EN60947-5-6
- Electromagnetic compatibility (EMC) according to EN60947-5-2
- Shock and vibration resistance according to EN60068-2-27 EN60068-2-6
- For certified ATEX version see ATEX Catalogue

Flush mounting Non flush mounting	Sensing zone diameter	Max switching frequency (f)	Nominal sensing distance (S _n) ± 10%	ORDERING REFERENCES
	mm	KHz	mm	
•	30	0,2	15	DCP/4700
•	30	0,2	20	DCP/5700

Type P - 5 Positions head •
Amplified in d.c. •
Terminal block output •

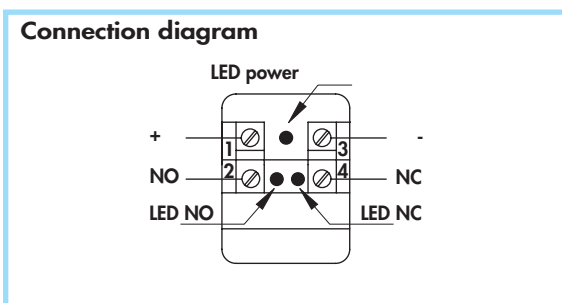
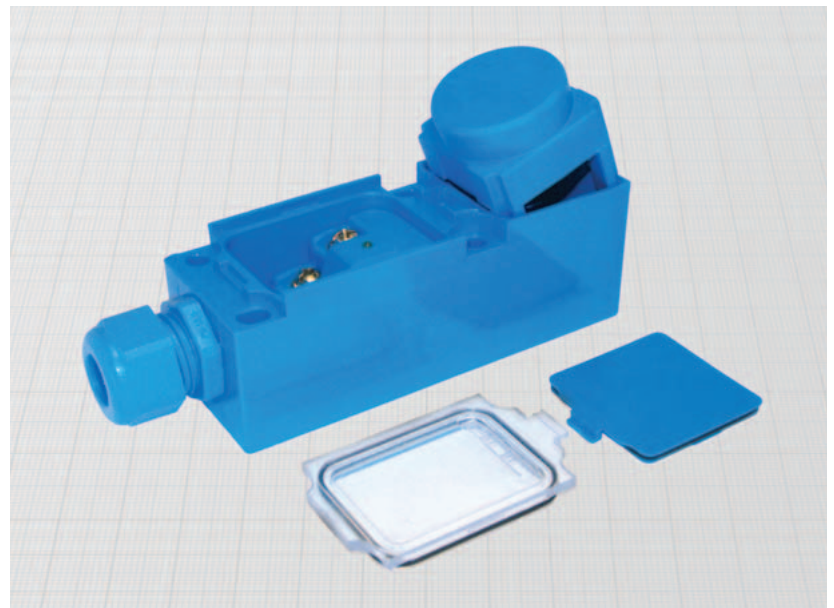
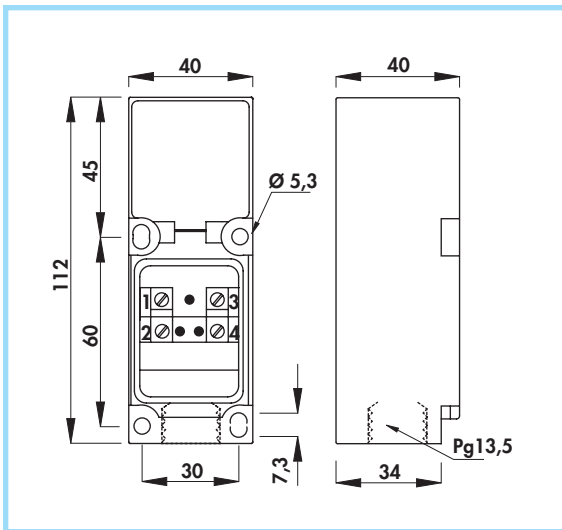

Materials:

- Housing: plastic
- Terminal block cover: polycarbonate

General Features:

These sensors are called "turnable sensing head" because the sensing head, inside the plastic housing can be positioned on 5 different positions. To choose the desired sensing face it is enough to remove the cover and set the sensing head in the proper position.

The internal terminal block can be easily reached by removing the transparent cover. The included plastic gland Pg13.5 is suited for cables diameter up to 9 mm.

Technical data:

- Supply voltage (U_B): 10 ÷ 60 Vdc
- Max ripple: 10%
- No-load supply current (I_0): ≤ 10 mA
- Voltage drop (U_d): ≤ 2.2 V
- Temperature range: -25° ÷ +70°C
- Max thermal drift of sensing distance S_r : ± 10%
- Repeat accuracy (R): 4%
- Switching hysteresis (H): 10%
- Degree of protection (with fully locked gland): IP65
- Indications:
 - output n.o. yellow LED
 - output n.c. red LED
 - power green LED

- Protected against short-circuit and overload
- Protected against any wrong connection
- Suppression of initial false impulse
- Electromagnetic compatibility (EMC) according to EN60947-5-2
- Shock and vibration resistance according to EN60068-2-27 EN60068-2-6



Flush mounting Non flush mounting	Sensing zone diameter	Max switching frequency (f)	Rated operational current (I _e)	Nominal sensing distance (S _n) ± 10%	ORDERING REFERENCES	
					PNP	NPN
					NO + NC	NO + NC
•	30	0,1	400	15	DCAP/4729KS	DCAP/4728KS
•	30	0,1	400	20	DCAP/5729KS	DCAP/5728KS

RECTANGULAR INDUCTIVE SENSORS

- **Type P - 5 Positions head**
- **Amplified in a.c.**
- **Terminal block output**

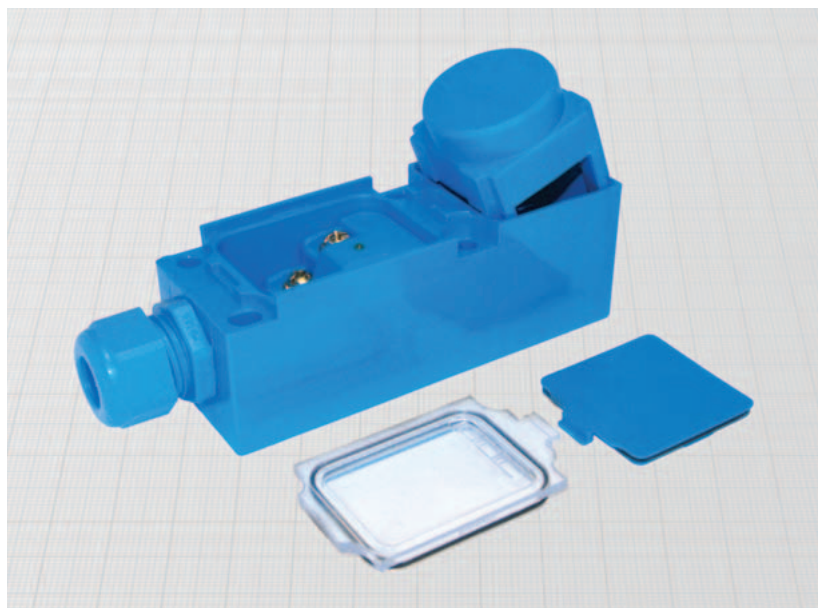
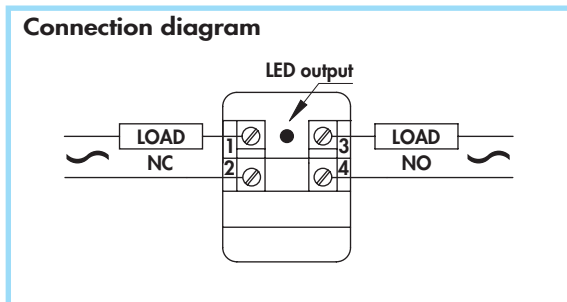
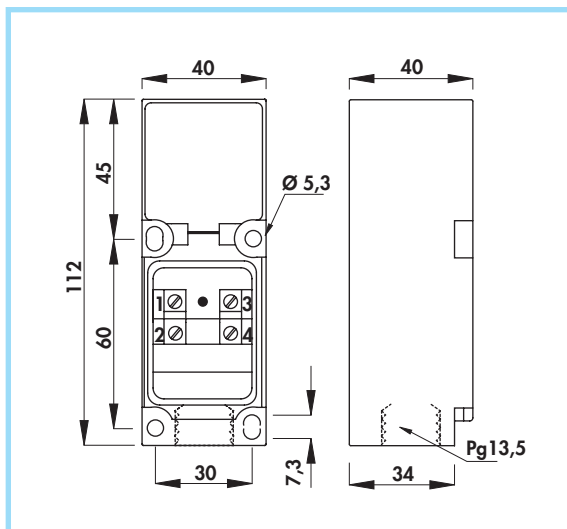

Materials:

- Housing: plastic
- Terminal block cover: pycarbonate

General Features:

These sensors are called "turnable sensing head" because the sensing head, inside the plastic housing can be positioned on 5 different positions. To choose the desired sensing face it is enough to remove the cover and set the sensing head in the proper position.

The internal terminal block can be easily reached by removing the transparent cover. The included plastic gland Pg13.5 is suited for cables diameter up to 9 mm.

Technical data:

- Supply voltage (U_B): 20 ÷ 240 Vac
- Electrical system frequency: 40 ÷ 60 Hz
- Off-state current (I_o): ≤ 1,5 mA at 110 Vac
- Minimum operational current (I_m): 5 mA
- Voltage drop (U_d): ≤ 5 V
- Temperature range: - 25° ÷ + 70°C
- Max thermal drift of sensing distance S_s : ± 10%
- Repeat accuracy (R): 4%
- Switching hysteresis (H): 10%
- Degree of protection (with fully locked gland): IP65
- Switch status indicator: yellow LED
- Suppression of initial false impulse
- Class 2 equipment according to IEC 536
- Shock and vibration according to EN60068-2-27 EN60068-2-6
- Electromagnetic compatibility (EMC) according to EN60947-5-2

Flush mounting Non flush mounting	Sensing zone diameter	Max switching frequency (f)	Rated operational current (I_e)	Nominal sensing distance (S_n) ± 10%	ORDERING REFERENCES	
	mm	Hz	mA	mm		
•	30	25	500	15	ACP/4709S	ACP/4719S
•	30	25	500	20	ACP/5709S	ACP/5719S

NAMUR SERIES - diameter 80 mm •
Non-amplified in d.c. 2 wires •
Cable and connector output M12 x 1 •

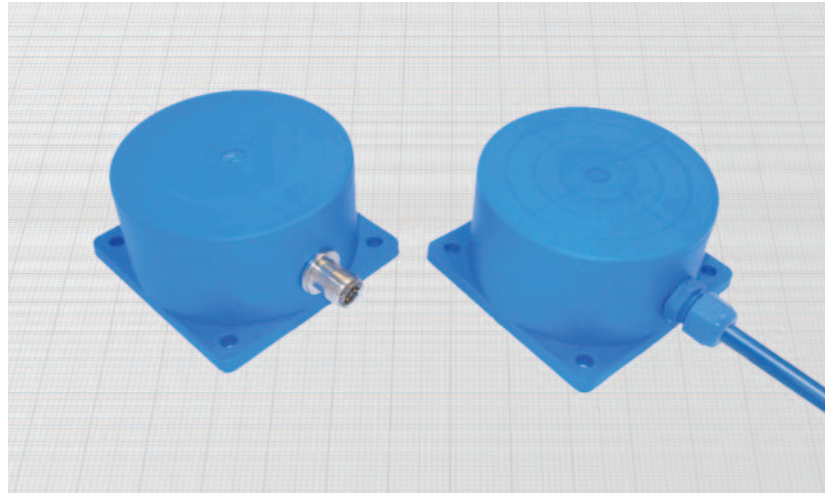
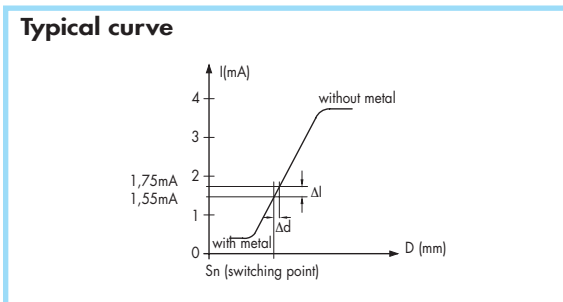
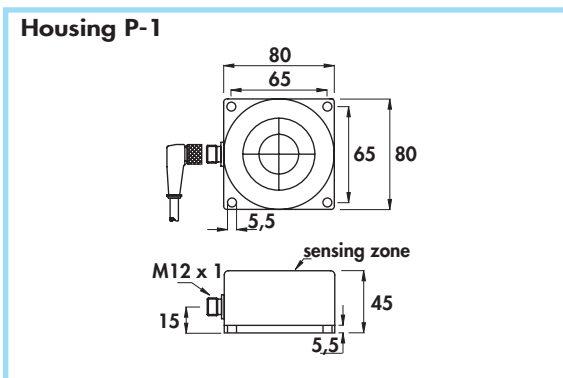
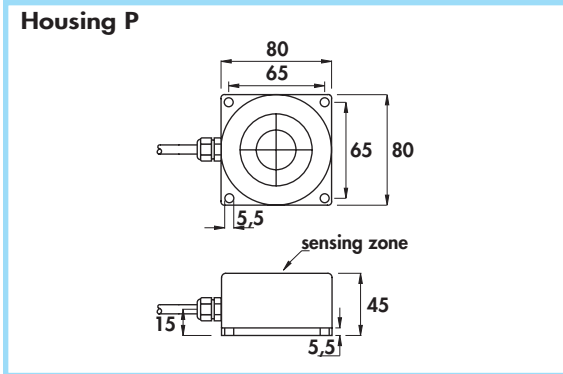

Materials:

- Cable: 2 m PVC CEI 20 - 22 II; 90°C; 300 V; O.R.
- Housing: plastic
- Connector: nickel plated brass

Technical data:

- Working voltage: $5 \div 30$ Vdc
- Supply voltage according to NAMUR: $7,7 \div 9$ Vdc
- Max ripple: 10%
- Consumption at 8,2 V con $R_x = 1000 \Omega$
 - with metal: ≤ 1 mA
 - without metal: ≥ 3 mA
- Temperature range: $-25^\circ \div +70^\circ$ C
- Max thermal drift of sensing distance S_n : $\pm 10\%$
- Repeat accuracy (R): 2%
- Degree of protection: IP67
- Cable conductor cross section (cable version): $0,75$ mm²
- According to EN60947-5-6
- Electromagnetic compatibility (EMC) according to EN60947-5-2
- Shock and vibration resistance according to EN60068-2-27 EN60068-2-6
- For certified ATEX version see ATEX Catalogue

Housing	Flush mounting Non flush mounting	Cable diameter	Female connector	Sensing zone diameter	Max switching frequency (f)	Nominal sensing distance (S _n) ± 10%	ORDERING REFERENCES
		mm	n°	mm	KHz	mm	
P	•	5	-	80	0,5	40	DC80B/5800
P-1	•	-	6-8B-10	80	0,5	40	DC80B/5300

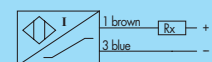

RECTANGULAR INDUCTIVE SENSORS

- Diameter 80 mm
- Amplified in d.c. 3 and 4 wires
- Cable and connector output M12 x 1

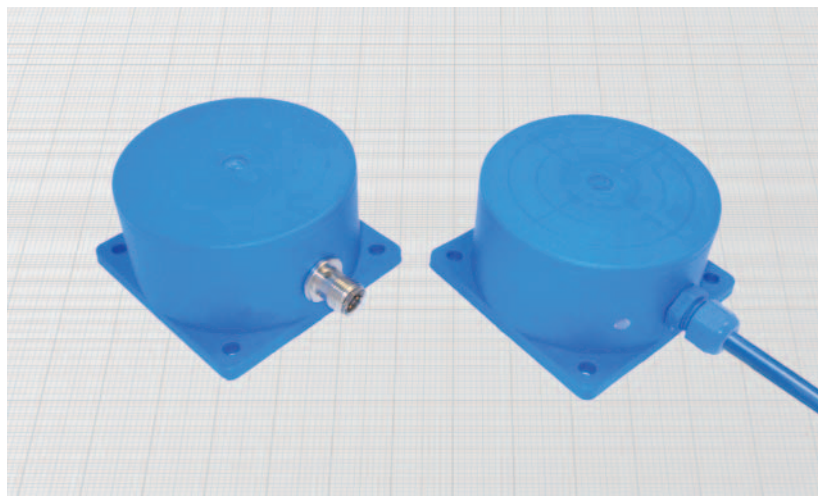
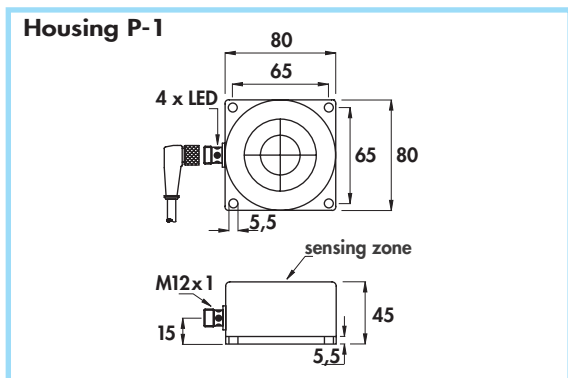
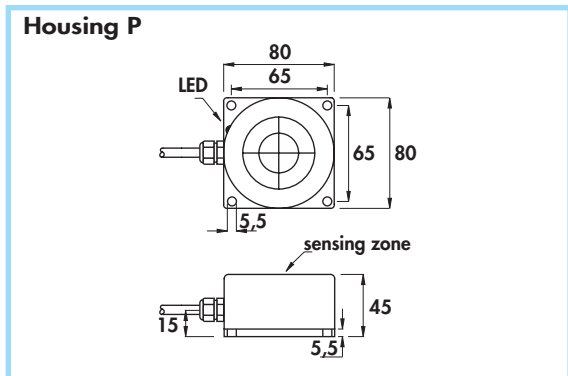

Materials:

- Cable: 2 m PVC CEI 20 - 22 II; 90°C; 300 V; O.R.
- Housing: plastic
- Connector: nickel plated brass

Technical data:

- Supply voltage (U_b): 10 ÷ 60 Vdc
- Max ripple: 10%
- No-load supply current (I_0): ≤ 10 mA
- Voltage drop (U_d): ≤ 2,2 V
- Temperature range: - 25° ÷ + 70°C
- Max thermal drift of sensing distance S_T : ± 10%
- Repeat accuracy (R): 2%
- Switching hysteresis (H): 10%
- Degree of protection: IP67
- Switch status indicator: yellow LED
- Cable conductor cross section (cable version): 0,50 mm²
- Protected against short-circuit and overload
- Protected against any wrong connection
- Suppression of initial false impulse
- Electromagnetic compatibility (EMC) according to EN60947-5-2
- Shock and vibration resistance according to EN60068-2-27 EN60068-2-6

Housing	Flush mounting Non flush mounting	Cable diameter	Female connector	Sensing zone diameter	Max switching frequency (F)	Rated operational current (I_e)	Nominal sensing distance (S_n) ± 10%	ORDERING REFERENCES		
								PNP (positive switching)		
								NO	NC	NO + NC
P	•	6	-	80	0,5	400	40			
P-1	•	-	6-8B-10	80	0,5	400	40			
								NPN (negative switching)		
								Use the above mentioned part number changing the last number 9 with 8 (ie. DCA80B/5808KS)		
								NO	NC	NO + NC

Diameter 80 mm •
 Amplified in a.c. 2 wires •
 Cable and connector output M12 x 1 •

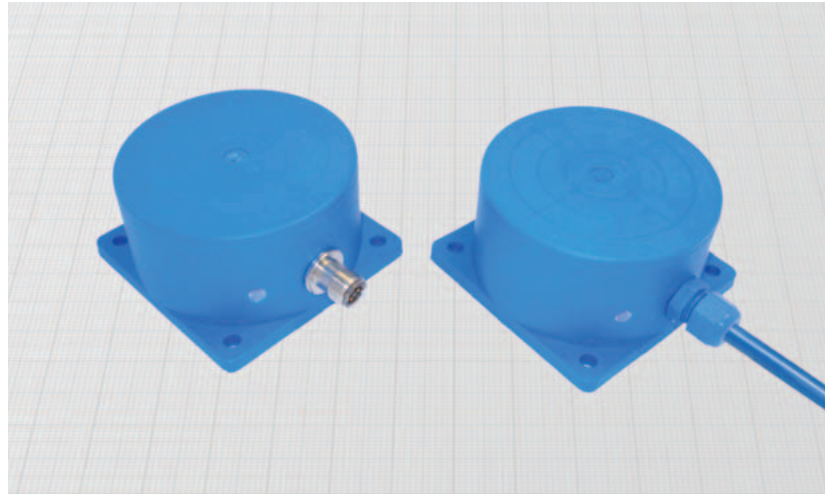
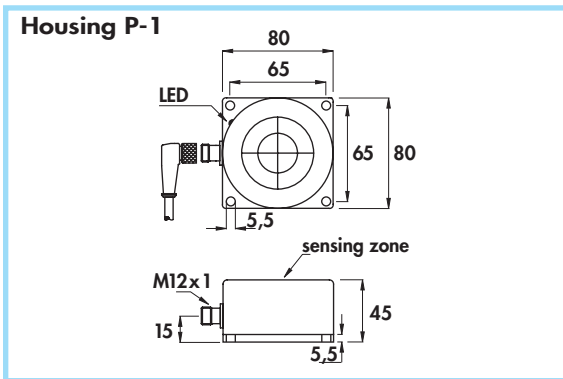
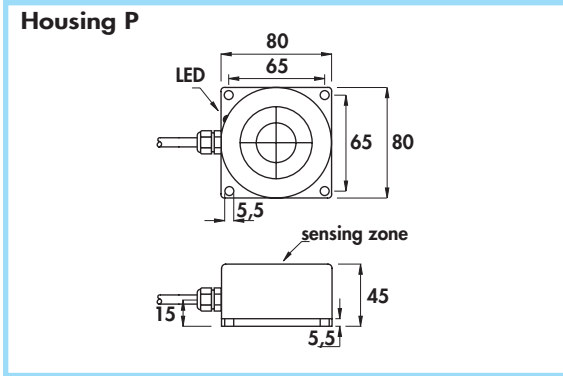

Materials:

- Cable: 2 m PVC CEI 20 - 22 II; 90°C; 300 V; O.R.
- Housing: plastic
- Connector: nickel plated brass

Technical data:

- Supply voltage (U_B): 20 ÷ 240 Vac
- Electrical system frequency: 40 ÷ 60 Hz
- Off-state current (I_o): ≤ 1,5 mA at 110 Vac
- Minimum operational current (I_m): 5 mA
- Voltage drop (U_d): ≤ 5 V
- Temperature range: -25° ÷ +70°C
- Max thermal drift of sensing distance S_r : ± 10%
- Repeat accuracy (R): 2%
- Switching hysteresis (H): 10%
- Degree of protection: IP67
- Switch status indicator: yellow LED
- Cable conductor cross section (cable version): 0,75 mm²
- Suppression of initial false impulse
- Class 2 equipment according to IEC 536
- Shock and vibration according to EN60068-2-27 EN60068-2-6
- Electromagnetic compatibility (EMC) according to EN60947-5-2

Housing	Flush mounting Non flush mounting	Cable diameter	Female connector	Sensing zone diameter	Max switching frequency (f)	Rated operational current (I _e)	Nominal sensing distance (S _n) ± 10%	ORDERING REFERENCES	
								Cable output	
P	•	6	-	80	15	500	40	NO black black	NC black black
								AC80B/5809S	AC80B/5819S
P-1	•	-	15-16	80	15	500	40	4 PIN connector	
								NO 1 brown 2 blue	NC 1 brown 2 blue
P-1	•	-	17-18	80	15	500	40	3 PIN connector according to EN60947-5-2	
								NO 3 blue 2 brown	NC 3 blue 2 brown
P-1	•	-	17-18	80	15	500	40	AC80B/5009S	AC80B/5019S

RECTANGULAR INDUCTIVE SENSORS

- **NAMUR SERIES - Type R - Adjustable sensing distance**
- **Non-amplified in d.c. 2 wires**
- Cable and connector output M12 x 1

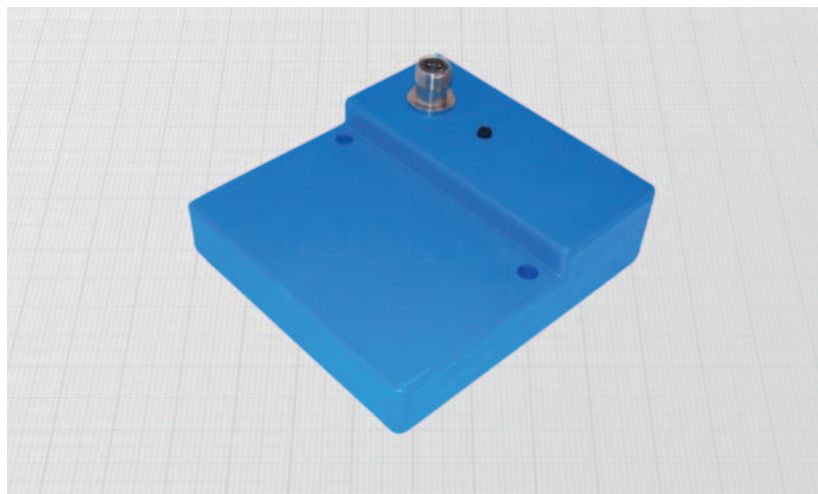
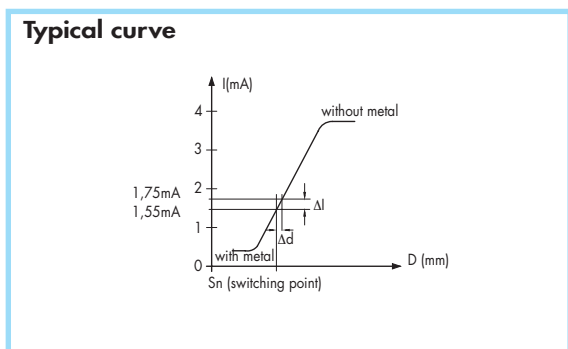
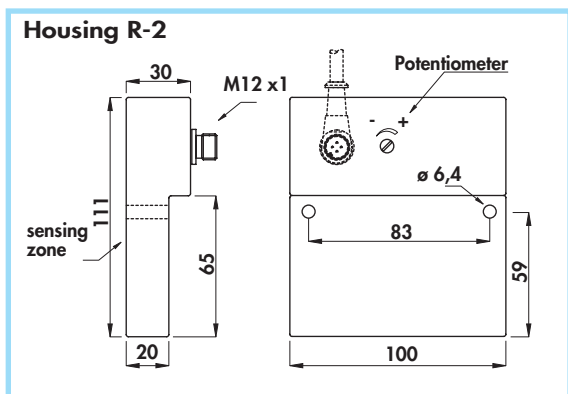
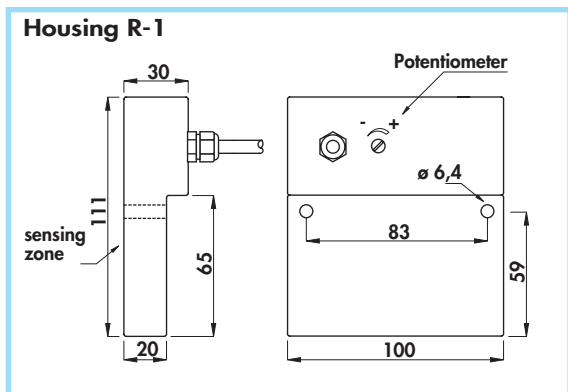

General Features:

These sensors are suitable for non flush mounting and have the adjustable sensing distance turning a multiturn potentiometer.

Technical data:

- Working voltage: $5 \div 30$ Vdc
- Supply voltage according to NAMUR: $7,7 \div 9$ Vdc
- Max ripple: 10%
- Consumption at 8,2 V con $R_x = 1000 \Omega$
 - with metal: ≤ 1 mA
 - without metal: ≥ 3 mA
- Temperature range: $-20^\circ \div +70^\circ\text{C}$
- Max thermal drift of sensing distance S_p : $\pm 10\%$
- Repeat accuracy (R): 4%
- Degree of protection: IP65
- Cable conductor cross section (cable version): $0,75 \text{ mm}^2$
- According to EN60947-5-6
- Electromagnetic compatibility (EMC) according to EN60947-5-2
- Shock and vibration resistance according to EN60068-2-27 EN60068-2-6
- For certified ATEX version see ATEX Catalogue

Materials:

- Cable: 2 m PVC CEI 20 - 22 II; 90°C ; 300 V; O.R.
- Housing: plastic
- Connector: nickel plated brass

Housing	Flush mounting Non flush mounting	Cable diameter	Female connector	Sensing zone diameter	Max switching frequency (f)	Distanza nominale di mt. (S _n)	ORDERING REFERENCES
							mm
R - 1	•	5	-	75	0,3	10 ÷ 55	DCR/5800
R - 2	•	-	6 - 8B - 10	75	0,3	10 ÷ 55	DCR/5300

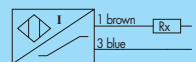

Type R - Adjustable sensing distance •
Amplified in d.c. 3 and 4 wires •
Cable and connector output M12 x 1 •

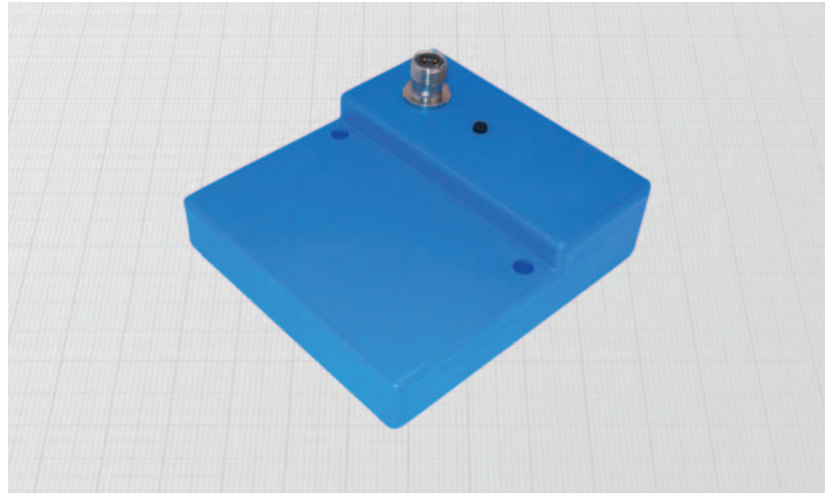
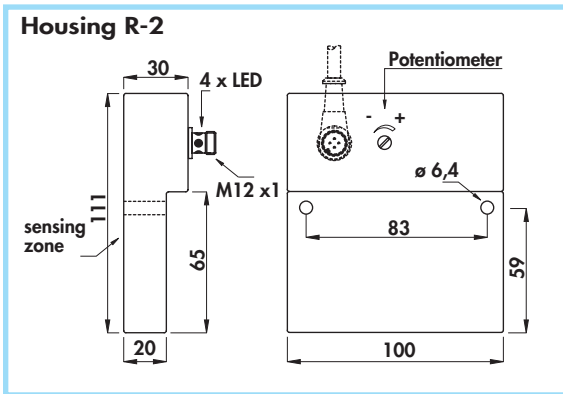
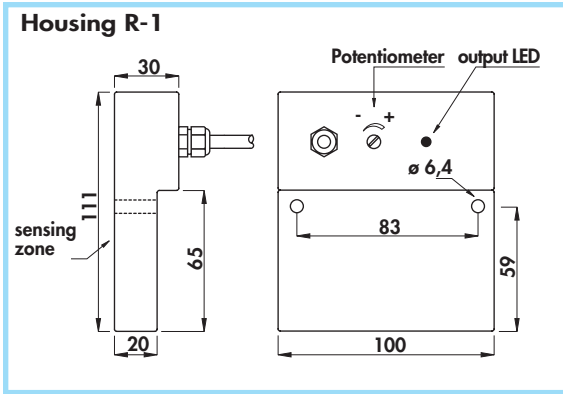

Materials:

- Cable: 2 m PVC CEI 20 - 22 II; 90°C; 300 V; O.R.
- Housing: plastic
- Connector: nickel plated brass

General Features:

These sensors are suitable for non flush mounting and have the adjustable sensing distance turning a multiturn potentiometer.

Technical data:

- Supply voltage (U_b): 10 ÷ 60 Vdc
- Max ripple: 10%
- No-load supply current (I_o): ≤ 10 mA
- Voltage drop (U_d): ≤ 2,2 V
- Temperature range: -20° ÷ +70°C
- Max thermal drift of sensing distance S_s : ± 10%
- Repeat accuracy (R): 2%
- Switching hysteresis (H): 10%
- Degree of protection: IP65
- Switch status indicator: yellow LED
- Cable conductor cross section (cable version): 0,50 mm²
- Protected against short-circuit and overload
- Protected against any wrong connection
- Suppression of initial false impulse
- Electromagnetic compatibility (EMC) according to EN60947-5-2
- Shock and vibration resistance according to EN60068-2-27 EN60068-2-6

Housing	Mounting	Cable diameter	Female connector	Sensing zone diameter	Max switching frequency (f)	Rated operational current (I_o)	Nominal sensing distance (S_n) ± 10%	ORDERING REFERENCES		
								PNP (positive switching)		
R - 1	Flush mounting	6	-	75	0,3	400	10 ÷ 55	NO	NC	NO + NC
	Non flush mounting							DCAR/5809KS	DCAR/5819KS	DCAR/5829KS
R - 2	Non flush mounting	-	6 - 8B - 10	75	0,3	400	10 ÷ 55	DCAR/5309KS	DCAR/53C9KS	DCAR/5329KS
								NPN (negative switching)		
								Use the above mentioned part number changing the last number 9 with 8 (ie DCAR/5808KS)		
								NO	NC	NO + NC

RECTANGULAR INDUCTIVE SENSORS

- **Type R - Adjustable sensing distance**
- **Amplified in a.c. 2 wires**
- Cable and connector output M12 x 1

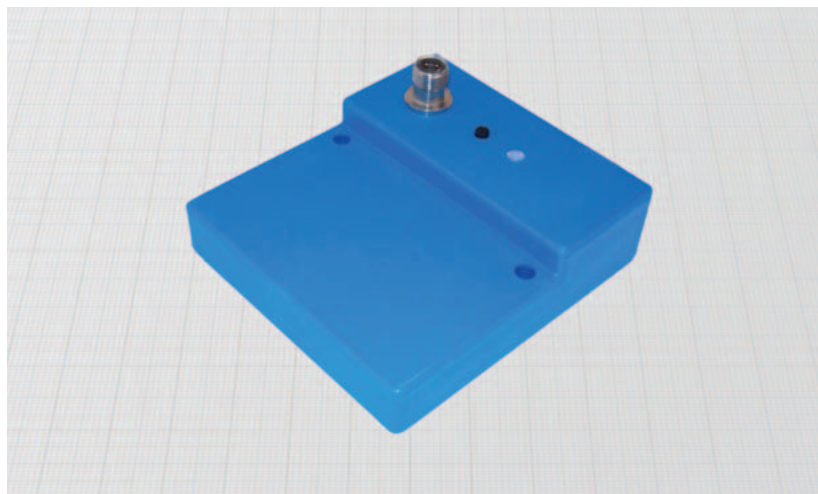
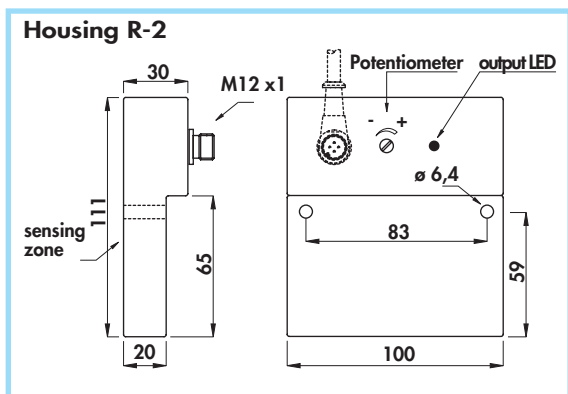
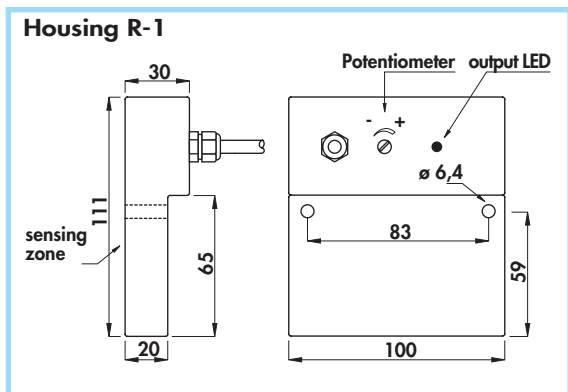

Materials:

- Cable: 2 m PVC CEI 20 - 22 II; 90°C; 300 V; O.R.
- Housing: plastic
- Connector: nickel plated brass

General Features:

These sensors are suitable for non flush mounting and have the adjustable sensing distance turning a multiturn potentiometer.

Technical data:

- Supply voltage (U_B): 20 ÷ 240 Vac
- Electrical system frequency: 40 ÷ 60 Hz
- Off-state current (I_o): ≤ 1,5 mA at 110 Vac
- Minimum operational current (I_m): 5 mA
- Voltage drop (U_d): ≤ 5 V
- Temperature range: - 20° ÷ + 70°C
- Max thermal drift of sensing distance S_T : ± 10%
- Repeat accuracy (R): 2%
- Switching hysteresis (H): 10%
- Degree of protection: IP65
- Switch status indicator: yellow LED
- Cable conductor cross section (cable version): 0,75 mm²
- Suppression of initial false impulse
- Class 2 equipment according to IEC 536
- Shock and vibration according to EN60068-2-27 EN60068-2-6
- Electromagnetic compatibility (EMC) according to EN60947-5-2

Housing	Flush mounting Non flush mounting	Cable diameter	Female connector	Sensing zone diameter	Max switching frequency (f)	Rated operational current (I _e)	Distanza nom. di int. (S _n)	ORDERING REFERENCES	
								Cable output	
		mm	n°	mm	Hz	mA	mm		
R - 1	•	6	-	75	20	500	10 ÷ 55	ACR/5809S	ACR/5819S
		mm	n°	mm	Hz	mA	mm	4 PIN connector	
R - 2	•	-	15 - 16	75	20	500	10 ÷ 55	ACR/5109S	ACR/5119S
								3 PIN connector according to EN60947-5-2	
R - 2	•	-	17 - 18	75	20	500	10 ÷ 55	ACR/5009S	ACR/5019S

NAMUR SERIES •
Non-amplified in d.c. 2 wires •
 Cable output •

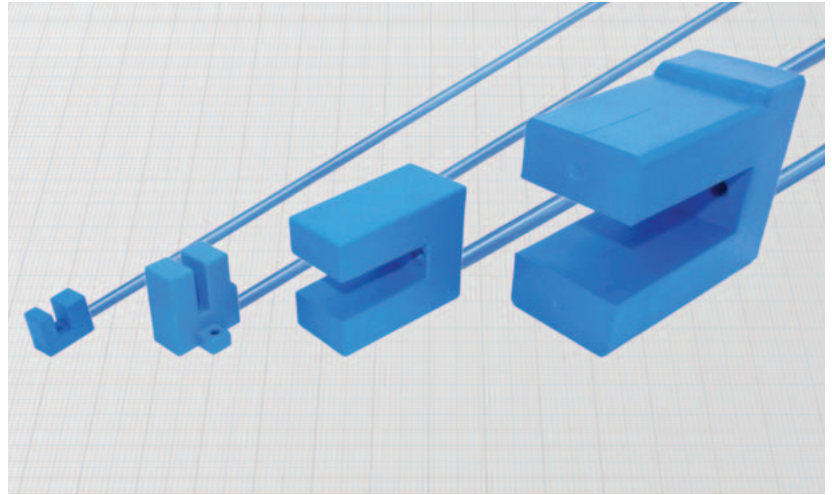
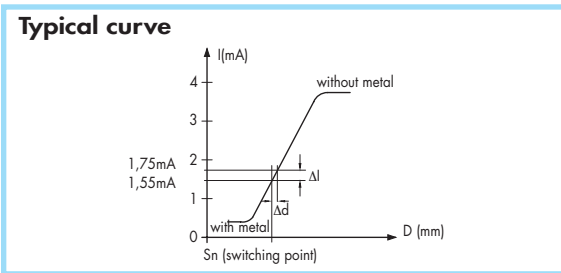
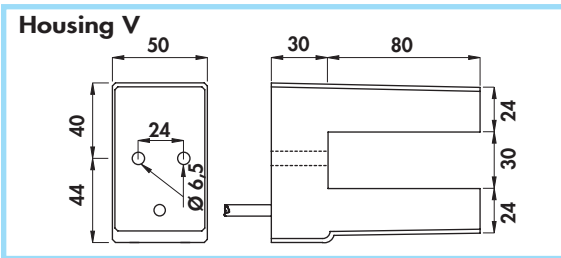
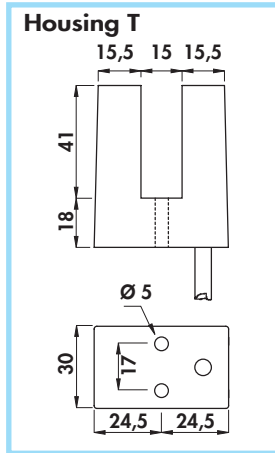
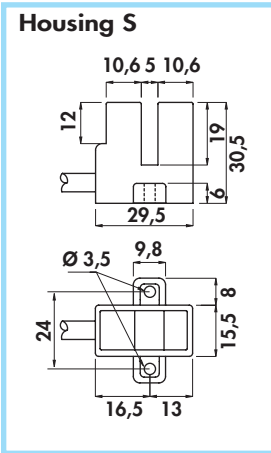
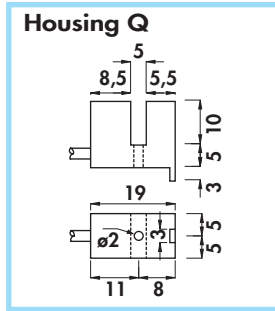
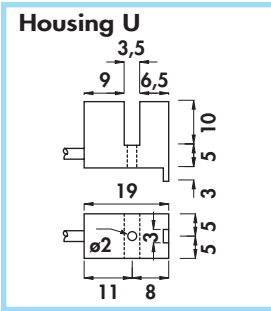

Technical data:

- Working voltage: $5 \div 30$ Vdc
- Supply voltage according to NAMUR: $7,7 \div 9$ Vdc
- Max ripple: 10%
- Consumption at 8,2 V con $R_x = 1000 \Omega$:
 - with metal: ≤ 1 mA
 - without metal: ≥ 3 mA
- Temperature range: $-25^\circ \div +70^\circ\text{C}$
- Max thermal drift of sensing distance S_s : $\pm 10\%$
- Repeat accuracy (R): 2%
- Degree of protection: IP67
- Cable conductor cross section:
 - $0,15 \text{ mm}^2$ on DF3,5/... and DF5/...
 - $0,75 \text{ mm}^2$ on DF6/..., DF15/... and DF30/...
- According to EN60947-5-6
- Electromagnetic compatibility (EMC) according to EN60947-5-2
- Shock and vibration resistance according to EN60068-2-27 EN60068-2-6
- For certified ATEX version see ATEX Catalogue

Materials:

- Cable: 2 m PVC CEI 20 - 22 II; 90°C ; 300 V; O.R.
- Housing: plastic
- Screw and nut (included on DF3,5... and DF5...) brass

Housing	Cable diameter	Gap width	Max switching frequency (f)	Minimum penetration	ORDERING REFERENCES
	mm	mm	KHz	mm	DF3,5/4600 DF5/4600 DF6/4600 DF15/4600 DF30/4600
U	3	3,5	3	5	DF3,5/4600
Q	3	5	3	5	DF5/4600
S	5	5	1	9	DF6/4600
T	5	15	0,8	16	DF15/4600
V	5	30	0,3	30	DF30/4600

INDUCTIVE SLOT SENSORS

- Amplified in d.c. 3 and 4 wires
- Cable output

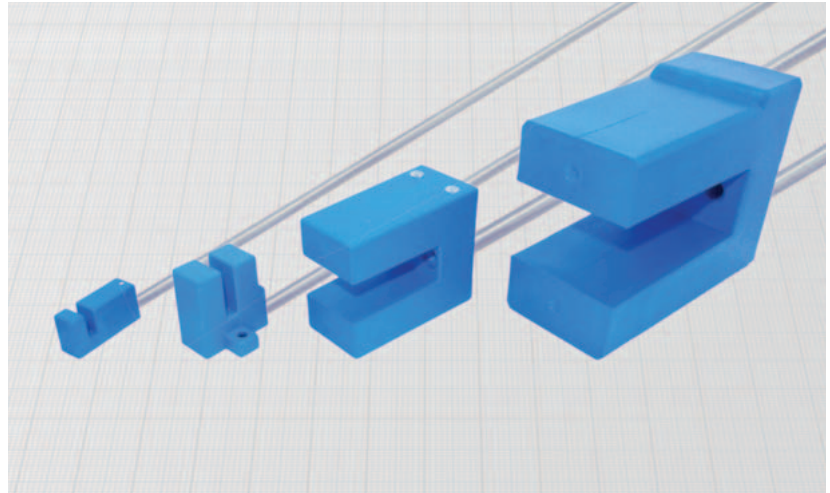
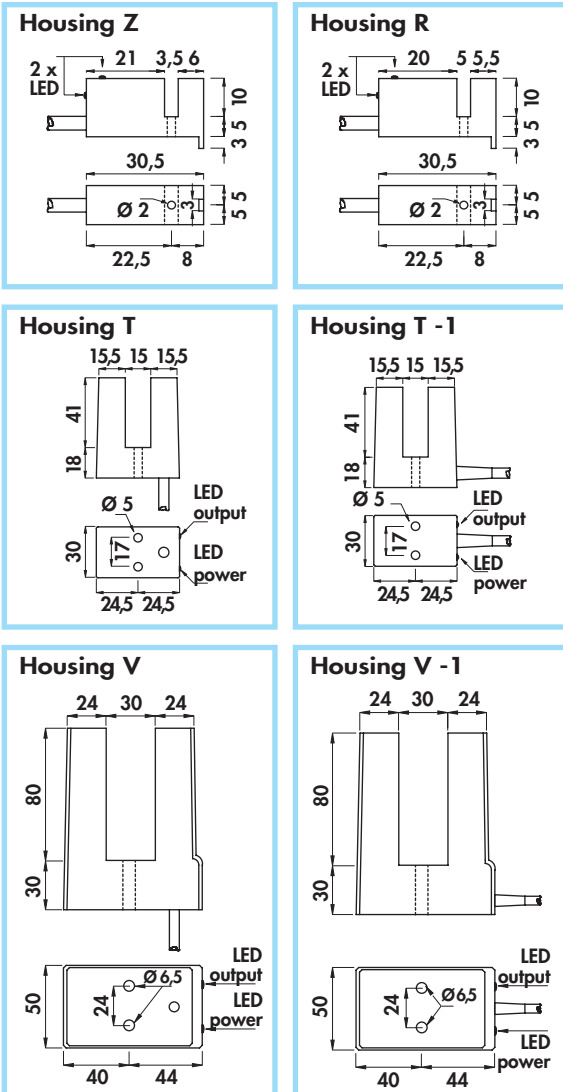

Technical data:

- Supply voltage (U_B) tipi DCF3,5/... and DCF5/... 10 ÷ 30 Vdc
- Supply voltage (U_B) tipi DCF15/... and DCF30/... 10 ÷ 60 Vdc
- Max ripple: 10%
- No-load supply current (I_0): ≤ 10 mA
- Voltage drop (U_d): $\leq 2,2$ V
- Temperature range: $-25^\circ \div +70^\circ$ C
- Max thermal drift of sensing distance S_r : $\pm 10\%$
- Repeat accuracy (R): 2%
- Switching hysteresis (H): 10%
- Degree of protection: IP67
- Switch status indicator: yellow LED
- Cable conductor cross section:
 - 0,22 mm² on DCF3,5/... and DCF5/...
 - 0,50 mm² on DCF15/... and DCF30/...

Materials:

- Cable: 2 m PVC CEI 20 - 22 II; 90°C; 300 V; O.R.
- Housing: plastic
- Screw and nut (included on mod. DF3,5... and DF5...) brass

- Protected against short-circuit and overload (versions with letter K)
- Protected against any wrong connection
- Suppression of initial false impulse
- Electromagnetic compatibility (EMC) according to EN60947-5-2
- Shock and vibration resistance according to EN60068-2-27 EN60068-2-6

Housing	Cable diameter	Gap width	Rated operational current (I_e)	Max switching frequency (f)	Minimum penetration	ORDERING REFERENCES		
						PNP (positive switching)		
	mm	mm	mA	KHz	mm			
Z	3,5	3,5	200	1	5	DCF3,5/4609KS	DCF3,5/4619KS	DCF3,5/4629KS
R	3,5	5	200	1	5	DCF5/4609KS	DCF5/4619KS	DCF5/4629KS
T	6	15	400	0,5	16	DCF15/4609KS	DCF15/4619KS	DCF15/4629KS
T - 1	6	15	400	0,5	16	DCF15/4L09KS	DCF15/4L19KS	DCF15/4L29KS
V	6	30	400	0,2	30	DCF30/4609KS	DCF30/4619KS	DCF30/4629KS
V - 1	6	30	400	0,2	30	DCF30/4L09KS	DCF30/4L19KS	DCF30/4L29KS
						NPN (negative switching) Use the above mentioned part number changing the last number 9 with 8 (ie. DCF3,5/4608KS)		

Amplified in d.c. •
Connector output M12 x 1 •

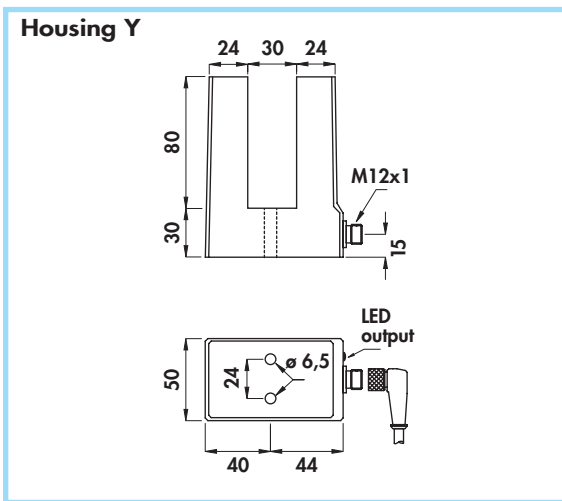
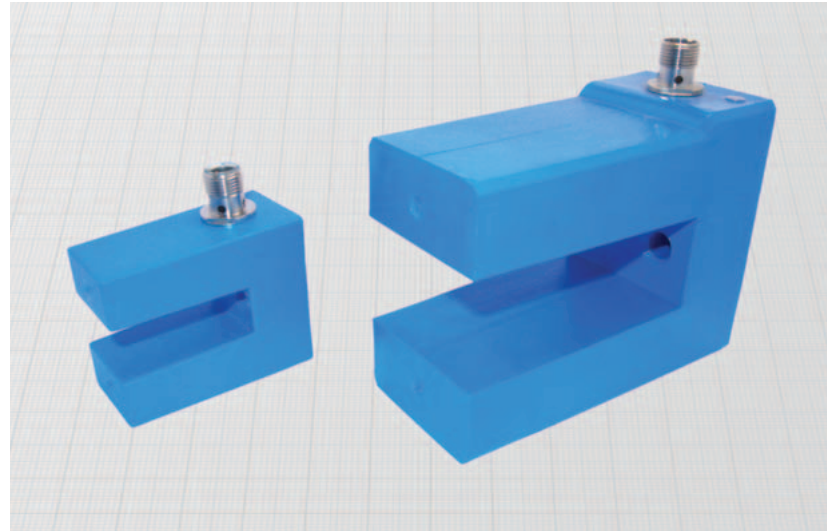
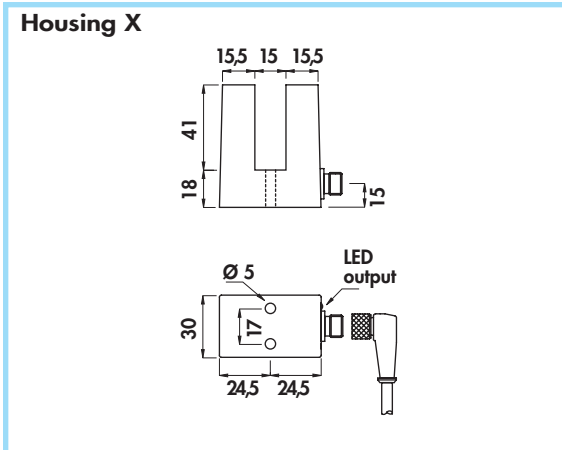

Materials:

- Housing: plastic
- Connector: nickel plated brass

Technical data:

- Supply voltage (U_B): 10 ÷ 60 Vdc
- Max ripple: 10%
- No-load supply current (I_0): ≤ 10 mA
- Voltage drop (U_d): ≤ 2,2 V
- Temperature range: -25° ÷ +70°C
- Max thermal drift of sensing distance S_T : ± 10%
- Repeat accuracy (R): 2%
- Switching hysteresis (H): 10%
- Degree of protection con connettori costampati: IP67
- Switch status indicator: yellow LED
- Protected against short-circuit and overload
- Protected against any wrong connection
- Suppression of initial false impulse
- Electromagnetic compatibility (EMC) according to EN60947-5-2
- Shock and vibration resistance according to EN60068-2-27 EN60068-2-6

Housing	Female connector	Gap width	Rated operational current (I_0)	Max switching frequency (f)	Minimum penetration	ORDERING REFERENCES		
						PNP (positive switching)		
n°	mm	mA	KHz	mm	NO	NC	NO + NC	
X	6-8B-10	15	400	0,5	16			
						DCF15/4309KS	DCF15/43C9KS	DCF15/4329KS
Y	6-8B-10	30	400	0,2	30			
						DCF30/4309KS	DCF30/43C9KS	DCF30/4329KS
						NPN (negative switching)		
						Use the above mentioned part number changing the last number 9 with 8 (ie. DCF15/4308KS)		

INDUCTIVE SLOT SENSORS

- Amplified in a.c. 2 wires
- Cable output

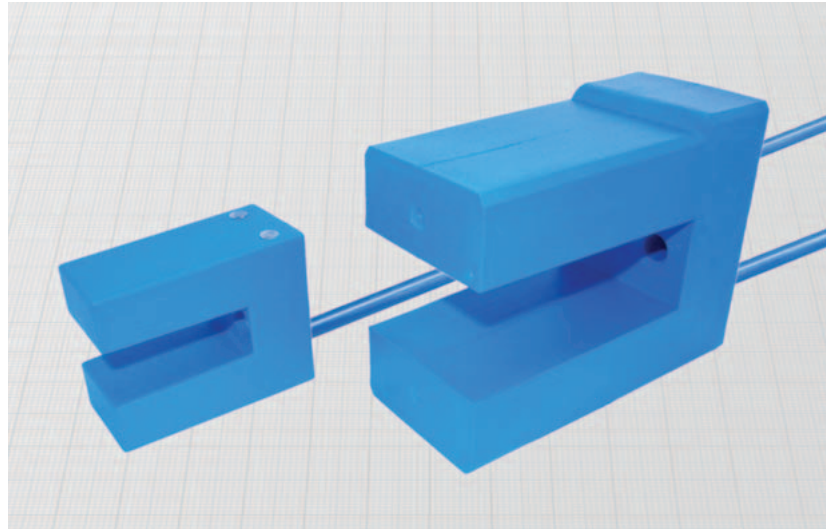
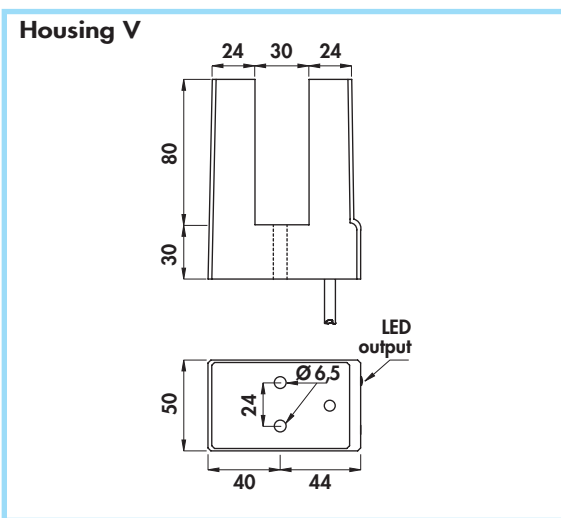
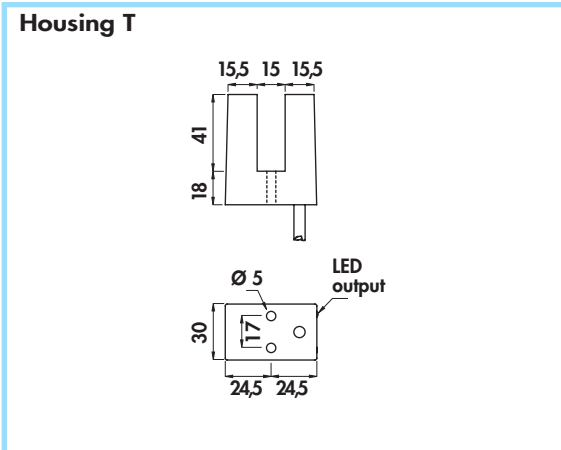

Materials:

- Cable: 2 m PVC CEI 20 - 22 II; 90°C; 300 V; O.R.
- Housing: plastic

Technical data:

- Supply voltage (U_B): 20 ÷ 240 Vac
- Electrical system frequency: 40 ÷ 60 Hz
- Off-state current (I_f): ≤ 1,5 mA at 110 Vac
- Minimum operational current (I_m): 5 mA
- Voltage drop (U_d): ≤ 5 V
- Temperature range: - 25° ÷ + 70°C
- Max thermal drift of sensing distance S_T : ± 10%
- Repeat accuracy (R): 2%
- Switching hysteresis (H): 10%
- Degree of protection: IP67
- Switch status indicator: yellow LED
- Cable conductor cross section: 0,75 mm²
- Suppression of initial false impulse
- Class 2 equipment according to IEC 536
- Shock and vibration according to EN60068-2-27 EN60068-2-6
- Electromagnetic compatibility (EMC) according to EN60947-5-2

Housing	Cable diameter	Gap width	Rated operational current (I_e)	Max switching frequency (f)	Minimum penetration	ORDERING REFERENCES	
						NO	NC
T	6	15	500	15	16	ACF15/4609S	ACF15/4619S
V	6	30	500	15	30	ACF30/4609S	ACF30/4619S



CAPACITIVE SENSORS

Capacitive sensors detect the presence of any object into the sensible area. They have a higher sensitivity detecting metal objects or materials with a high content of water which have a high dielectric constant.

WORKING PRINCIPLE

An electrostatic field is generated in the sensible area. When an object gets in the sensing area changing its capacitive value, the oscillator stage starts oscillating, creating a commutation of the output stages. It's possible to adjust the sensing distance of capacitive sensors operating on the potentiometer placed on the back plastic cap or laterally in the connector versions. The factory regulation is the maximum value of the range declared on the catalogue.

CAPACITIVE SENSORS

- AKS** = amplified a.c.
- BKS** = amplified d.c.
- NKS** = NOT amplified d.c. NAMUR series

Diameter of cylindrical sensor.
For other types, change the number with the following:

- P** = rectangular plastic 5 positions head 40 x 40 x 112

- P** = plastic housing

- 4** = flush mounting
- 5** = non flush mounting

BKS	18	P/	4	6	0	9	KS	-5	PUR
------------	-----------	-----------	----------	----------	----------	----------	-----------	-----------	------------

- 3** = with connector M12 x 1
- 6** = standard type cable output
- *** = male connector cabled on sensor (see pag. H-1)

- 0** = NO (normally open output)
- 1** = NC (normally closed output)
- 2** = NO + NC (complementary outputs)
- C** = NC (normally closed output on pin 2 of connector)

- 0** = NAMUR series with 2 wires
- 8** = NPN
- 9** = PNP
- 9** = 20 ÷ 240 V. for a.c. sensors

- K** = protection against short circuit and overload
- S** = LED output status

Cable length (if required different than standard 2m)

For Polyurethane cable add PUR

NAMUR SERIES •
Non-amplified in d.c. 2 wires •
Cable output •

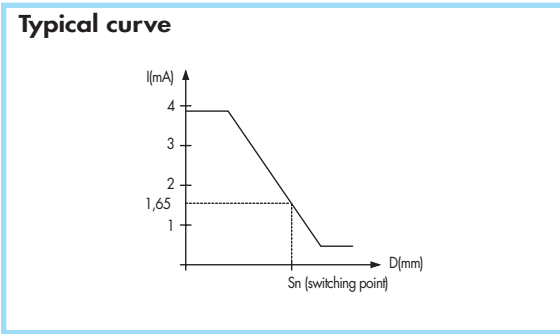
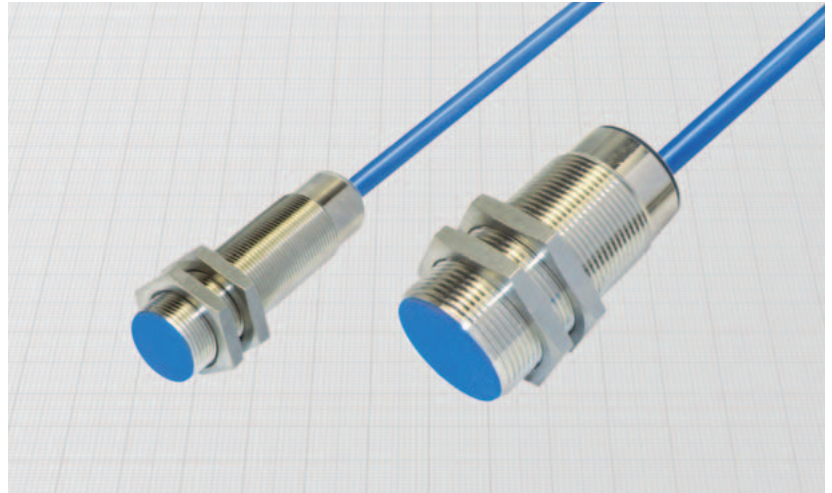
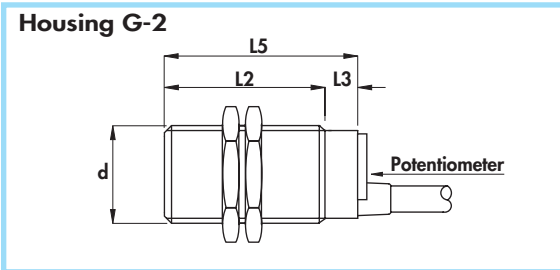
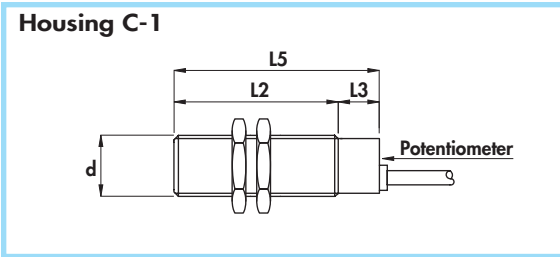

Diameter	M18 x 1	M30 x 1,5
Nut	Size	SW24
	Thickness mm	4
Max tightening torque Nm	35	80

Materials:

- Cable: 2 m PVC CEI 20 - 22 II; 90°C; 300 V; Ø.R.
- Housing: nickel plated brass
- Sensing face: plastic

General Features:

Capacitive sensors are suitable for any material detection. Some material, mostly if liquids, can be detected also through plastic or glass walls. They can be used for the most different applications: level controls on storage bin or tanks; detection of presence or filling of bottles; rain sensor; anti-vandalic key; etc. The adjustment of the sensing distance is possible through the potentiometer on the back cap.

Safety parameters:

- Working voltage: 7 ÷ 30 Vdc
- Supply voltage according to NAMUR: 7,7 ÷ 9 Vdc
- Max ripple: 10%
- Consumption at 8,2 V with Rx = 1000 Ω
 - with metal: ≥ 2,2 mA
 - without metal: ≤ 1 mA
- Temperature range: - 25° ÷ + 70°C
- Max thermal drift of sensing distance S_n: ± 20%
- Repeat accuracy (R): 4%
- Degree of protection: IP65
- Cable conductor cross section: 0,75 mm²
- According to EN60947-5-6
- Electromagnetic compatibility (EMC) according to EN60947-5-2 **CE**
- Shock and vibration resistance according to EN60068-2-27 EN60068-2-6
- For certified ATEX version see ATEX Catalogue

Housing	Flush mounting Non flush mounting	L1	L2	L3	L4	L5	Cable diameter	Body diameter (d)	Max switching frequency (f)	Nominal sensing distance (S _n) ±10%	ORDERING REFERENCES
		mm	mm	mm	mm	mm					
C - 1	•	-	50	10	-	60	5	M18 x 1	100	2 ÷ 5	NKS18/4600
G - 2	•	-	50	10	-	60	5	M30 x 1,5	100	4 ÷ 10	NKS30/4600

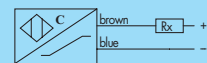

- Amplificati in c.c. a 4 fili
- Uscita a cavo

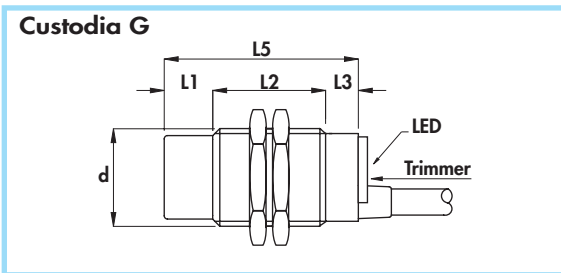
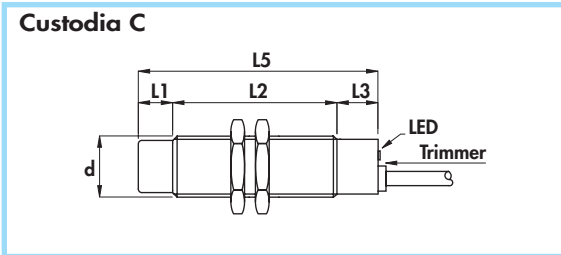

Diametro	M18 x 1	M30 x 1,5
Dado	Chiave	SW24
	Spess. mm	4
Coppia max di serraggio Nm	35	80

Materiali:

- Cavo: 2 m PVC CEI 20 - 22 II; 90°C; 300 V; O.R.
- Custodia: ottone nichelato
- Superficie sensibile: plastica

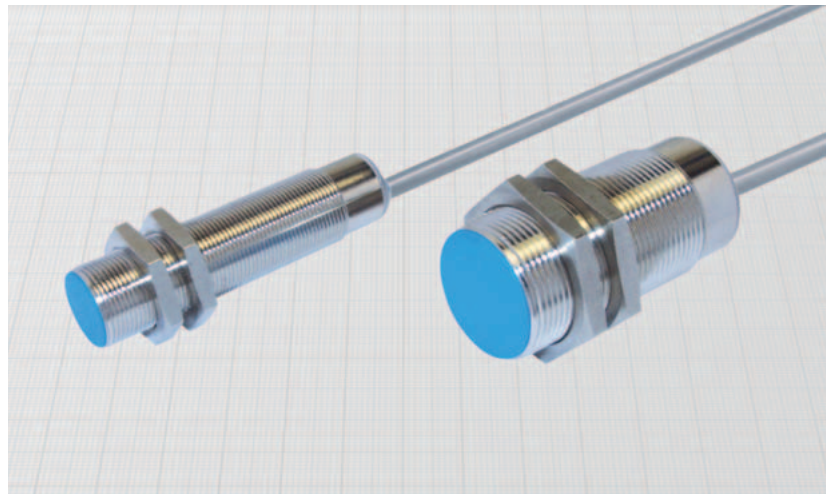

Generalità:

I sensori capacitivi sono adatti alla rilevazione di qualsiasi materiale. Alcuni materiali, specie se liquidi, possono essere rilevati anche attraverso pareti di plastica o vetro. Possono essere impiegati per le più svariate applicazioni: controlli di livello nei silos o nelle cisterne; rilevazione presenza o riempimento bottiglie; sensore di pioggia; tasto anti-vandalo; ecc.. La regolazione della distanza di intervento si effettua tramite un trimmer posto sul retro del corpo vicino al LED di segnalazione.

Caratteristiche tecniche:

- Tensione di alimentazione (U_B): 10 ÷ 60 Vcc
- Ondulazione residua max: 10%
- Corrente assorbita senza carico (I_0): ≤ 10 mA
- Caduta di tensione in chiusura (U_d): ≤ 2,2 V
- Temperatura di funzionamento: - 25° ÷ + 70°C
- Deriva termica max di S: ± 20%
- Precisione della ripetibilità (R): 4%
- Isteresi max (H): 15%
- Grado di protezione: IP65
- Visualizzazione stato di uscita: LED giallo
- Sezione conduttori interni: 0,35 mm² nel diametro 18 mm
0,50 mm² nel diametro 30 mm
- Protezione contro il corto circuito ed il sovraccarico
- Protezione contro qualsiasi inversione dei collegamenti
- Soppressione dell'impulso iniziale
- Urti e vibrazioni secondo EN60068-2-27 EN60068-2-6
- Compatibilità elettromagnetica (EMC) secondo EN60947-5-2

Tipo di custodia	Montaggio a filo Montaggio sporgente	L1	L2	L3	L4	L5	Diametro cavo	Diametro custodia (d)	Freq. max di commutazione (f)	Corrente di impiego nom. (I _e)	Distanza nom. di int. (S ₀)	CODICI DI ORDINAZIONE	
												PNP (uscita positiva)	
C	•	-	50	10	-	60	5	M18 x 1	100	400	2 ÷ 5	 BKS18/4629KS BKS18/5629KS	
C	•	10	40	10	-	60	5	M18 x 1	100	400	3 ÷ 10		
G	•	-	50	10	-	60	6	M30 x 1,5	100	400	3 ÷ 10	 BKS30/4629KS BKS30/5629KS	
G	•	15	35	10	-	60	6	M30 x 1,5	100	400	5 ÷ 20		

NPN (uscita negativa)

Sostituire nel codice l'ultima cifra 9 con 8 (es. BKS18/4628KS)

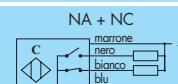

Amplified in d.c. •
Connector output M12 x 1 •

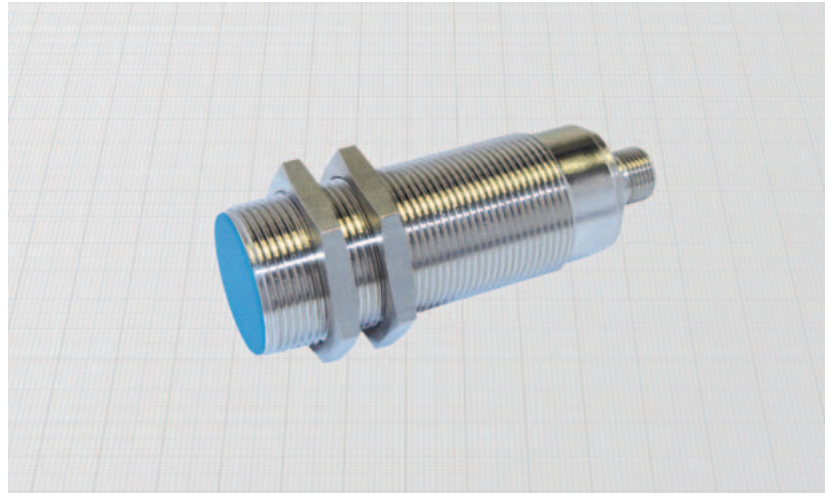
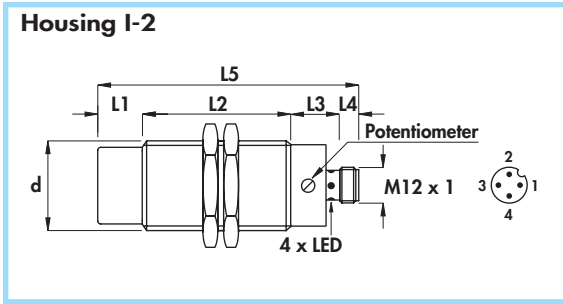

Diameter	M30 x 1,5	
Nut	Size	SW36
	Thickness mm	5
Max tightening torque Nm	80	

Materials:

- Housing: nickel plated brass
- Sensing face: plastic

General Features:

Capacitive sensors are suitable for any material detection. Some material, mostly if liquids, can be detected also through plastic or glass walls. They can be used for the most different applications: level controls on storage bin or tanks; detection of presence or filling of bottles; rain sensor; anti-vandalic key; etc. The adjustment of the sensing distance is possible through the potentiometer on the smooth part of the housing.

Technical data:

- Supply voltage (U_B): 10 ÷ 60 Vdc
- Max ripple: 10%
- No-load supply current (I_0): ≤ 10 mA
- Voltage drop (U_d): ≤ 2,2 V
- Temperature range: - 25° ÷ + 70°C
- Max thermal drift of sensing distance S_r : ± 20%
- Repeat accuracy (R): 4%
- Switching hysteresis max (H): 15%
- Degree of protection: IP65
- Switch status indicator: yellow LED
- Protected against short-circuit and overload
- Protected against any wrong connection
- Suppression of initial false impulse
- Electromagnetic compatibility (EMC) according to EN60947-5-2
- Shock and vibration resistance according to EN60068-2-27 EN60068-2-6

Housing	Mounting Flush mounting Non flush mounting	L1	L2	L3	L4	L5	Female connector	Body diameter (d)	Max switching frequency (f)	Rated operational current (I _e)	Nominal sensing distance (S _n) ± 10%	ORDERING REFERENCES	
		mm	mm	mm	mm	mm						n°	mm
I-2	•	-	50	18	8	76	6-8B-10	M30 x 1,5	100	400	3 ÷ 10	NO + NC 	
I-2	•	15	35	18	8	76	6-8B-10	M30 x 1,5	100	400	5 ÷ 20	BKS30S/4329KS BKS30S/5329KS	
												NPN (negative switching) Use the above mentioned part number changing the last number 9 with 8 (ie. BKS30S/4328KS)	
												NO + NC 	

- Amplificati in c.a. a 2 fili + terra
- Uscita a cavo

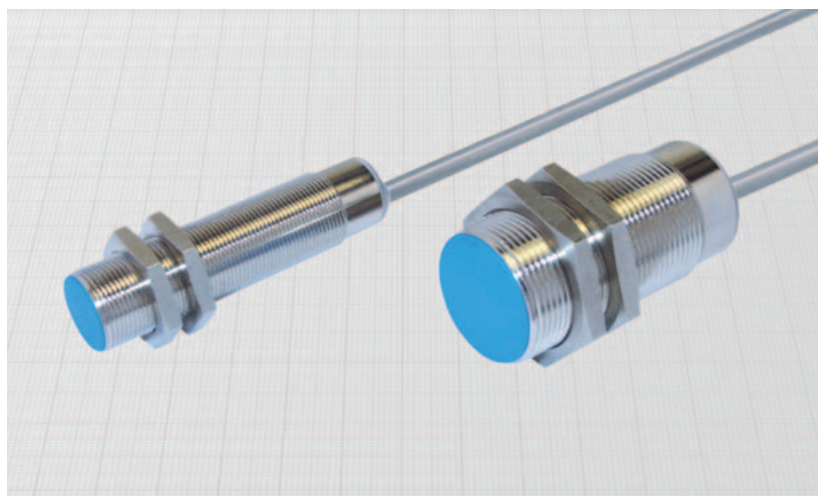
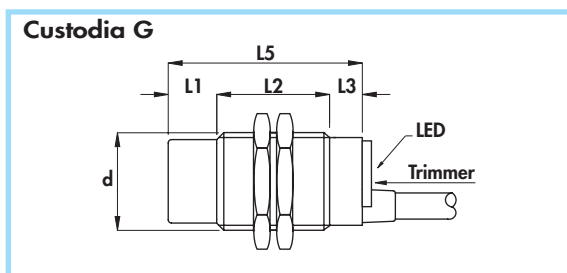
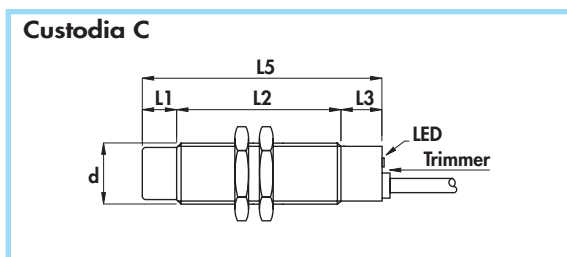

Diametro	M18 x 1	M30 x 1,5	
Dado	Chiave	SW24	SW36
	Spess. mm	4	5
Coppia max di serraggio Nm	35	80	

Materiali:

- Cavo: 2 m PVC CEI 20 - 22 II; 90°C; 300 V; O.R.
- Custodia: ottone nichelato
- Superficie sensibile: plastica

Generalità:

I sensori capacitivi sono adatti alla rilevazione di qualsiasi materiale. Alcuni materiali, specie se liquidi, possono essere rilevati anche attraverso pareti di plastica o vetro. Possono essere impiegati per le più svariate applicazioni: controlli di livello nei silos o nelle cisterne; rilevazione presenza o riempimento bottiglie; sensore di pioggia; tasto anti-vandalo; ecc.. La regolazione della distanza di intervento si effettua tramite un trimmer posto sul retro del corpo vicino al LED di segnalazione.

Caratteristiche tecniche:

- Tensione di alimentazione (U_B): 20 ÷ 240 Vca
- Frequenza di rete: 40 ÷ 60 Hz
- Corrente residua (I_r): ≤ 1,5 mA a 110 Vca
- Corrente di impiego minima (I_m): 5 mA
- Caduta di tensione in chiusura (U_d): ≤ 7 V
- Temperatura di funzionamento: - 25° ÷ + 70°C
- Deriva termica max di S_t : ± 20%
- Precisione della ripetibilità (R): 4%
- Isteresi max (H): 15%
- Grado di protezione: IP65
- Visualizzazione stato di uscita: LED giallo
- Sezione conduttori interni: 0,35 mm² nel diametro 18 mm
0,75 mm² nel diametro 30 mm
- Soppressione dell'impulso iniziale
- Urti e vibrazioni secondo EN60068-2-27 EN60068-2-6
- Compatibilità elettromagnetica (EMC) secondo EN60947-5-2

Tipo di custodia	Montaggio a filo Montaggio sporgente	L1	L2	L3	L4	L5	Diametro cavo	Diametro custodia (d)	Freq. max di commutazione (f)	Corrente di impiego nom. (I _e)	Distanza nom. di int. (S _n)	CODICI DI ORDINAZIONE	
		mm	mm	mm	mm	mm							
C	•	-	50	10	-	60	5	M18 x 1	10	250	2 ÷ 5	AKS18/4609S	AKS18/4619S
C	•	10	40	10	-	60	5	M18 x 1	10	250	3 ÷ 10	AKS18/5609S	AKS18/5619S
G	•	-	50	10	-	60	6	M30 x 1,5	10	250	3 ÷ 10	AKS30/4609S	AKS30/4619S
G	•	15	35	10	-	60	6	M30 x 1,5	10	250	5 ÷ 20	AKS30/5609S	AKS30/5619S

**NAMUR SERIES - diameters 18 - 30 mm •
Non-amplified in d.c. 2 wires •
Cable output •**

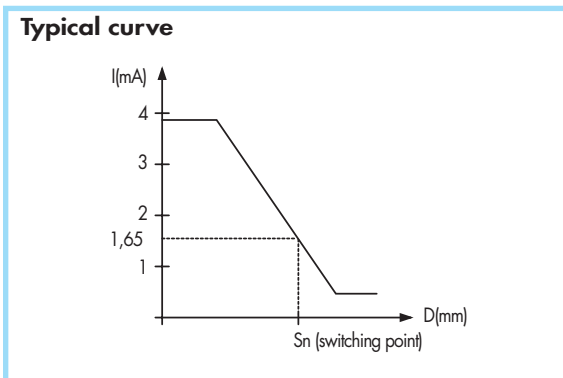
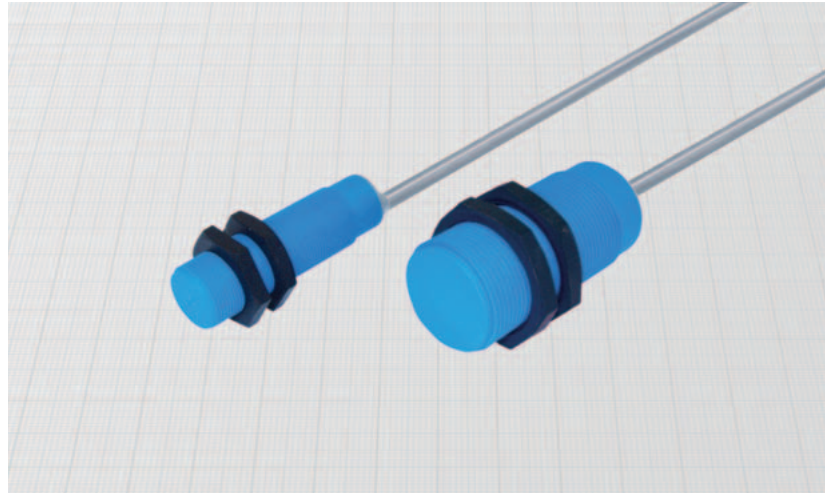
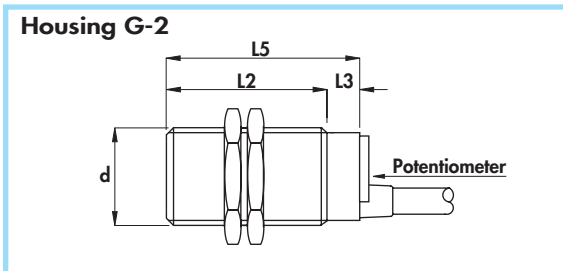
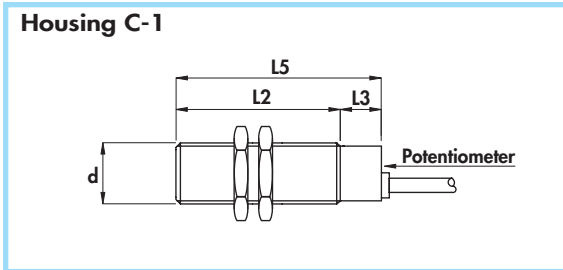

Diameter	M18 x 1	M30 x 1,5
Nut	Size	SW24
	Thickness mm	4
Max tightening torque Nm	5	20

Materials:

- Cable: 2 m PVC CEI 20 - 22 II; 90°C; 300 V; O.R.
- Housing: plastic
- Sensing face: plastic

General Features:

Capacitive sensors are suitable for any material detection. Some material, mostly if liquids, can be detected also through plastic or glass walls. They can be used for the most different applications: level controls on storage bin or tanks; detection of presence or filling of bottles; rain sensor; anti-vandalic key; etc.
The adjustment of the sensing distance is possible through the potentiometer on the back cap.

Safety parameters:

- Working voltage: $7 \div 30$ Vdc
- Supply voltage according to NAMUR: $7,7 \div 9$ Vdc
- Max ripple: 10%
- Consumption at 8,2 V with $R_x = 1000 \Omega$
 - with metal: $\geq 2,2$ mA
 - without metal: ≤ 1 mA
- Temperature range: $-25^\circ \div +70^\circ\text{C}$
- Max thermal drift of sensing distance S_r : $\pm 20\%$
- Repeat accuracy (R): 4%
- Degree of protection: IP65
- Cable conductor cross section: $0,75$ mm²
- According to EN60947-5-6
- Electromagnetic compatibility (EMC) according to EN60947-5-2
- Shock and vibration resistance according to EN60068-2-27 EN60068-2-6
- For certified ATEX version see ATEX Catalogue

Housing	Flush mounting Non flush mounting	L1	L2	L3	L4	L5	Cable diameter	Body diameter (d)	Max switching frequency (f)	Nominal sensing distance (S _n) ±10%	ORDERING REFERENCES
		mm	mm	mm	mm	mm					
C - 1	•	-	50	10	-	60	5	M18 x 1	100	2 ÷ 5	NKS18P/4600
G - 2	•	-	50	10	-	60	5	M30 x 1,5	100	4 ÷ 10	NKS30P/4600

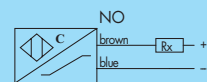

CYLINDRICAL CAPACITIVE SENSORS IN PLASTIC HOUSING

- Amplified in d.c. 4 wires
- Diameters 18 - 30 - 34 mm
- Cable output

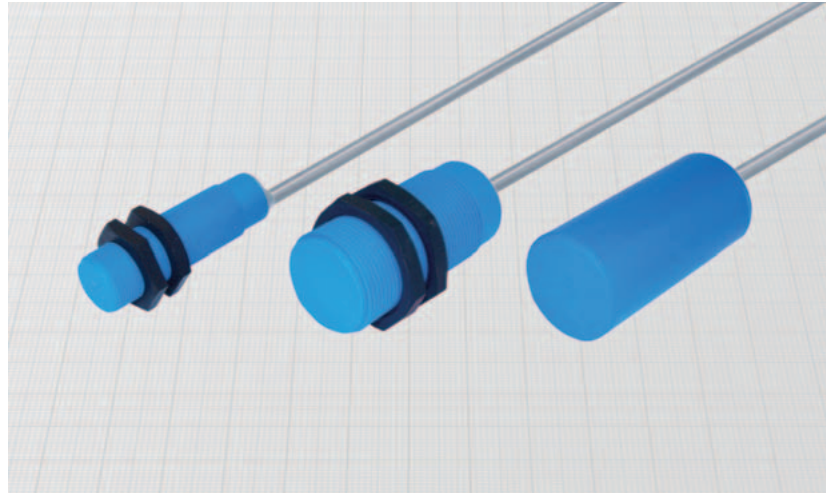
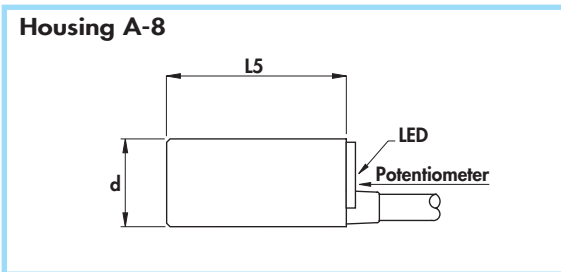
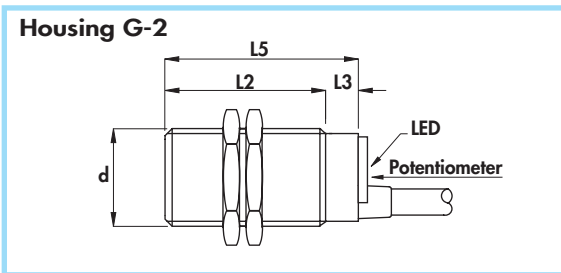
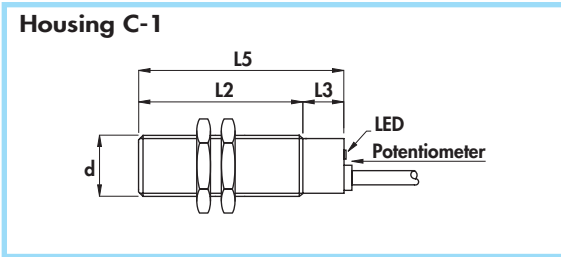

General Features:

Capacitive sensors are suitable for any material detection. Some material, mostly if liquids, can be detected also through plastic or glass walls. They can be used for the most different applications: level controls on storage bin or tanks; detection of presence or filling of bottles; rain sensor; anti-vandalic key; etc. The adjustment of the sensing distance is possible through the potentiometer on the back cap close to the LED.

Technical data:

- Supply voltage (U_b): 10 ÷ 60 Vdc
- Max ripple: 10%
- No-load supply current (I_o): ≤ 10 mA
- Voltage drop (U_d): ≤ 2,2 V
- Temperature range: - 25° ÷ + 70°C
- Max thermal drift of sensing distance S_r : ± 20%
- Repeat accuracy (R): 4%
- Switching hysteresis max (H): 15%
- Degree of protection: IP65
- Switch status indicator: yellow LED
- Cable conductor cross section: 0,50 mm²
- Protected against short-circuit and overload
- Protected against any wrong connection
- Suppression of initial false impulse
- Electromagnetic compatibility (EMC) according to EN60947-5-2
- Shock and vibration resistance according to EN60068-2-27 EN60068-2-6

Diameter	M18 x 1	M30 x 1,5
Nut	Size	SW24
	Thickness mm	4
Max tightening torque Nm	5	20

Materials:

- Cable: 2 m PVC CEI 20 - 22 II; 90°C; 300 V; O.R.
- Housing: plastic
- Sensing face: plastic

Housing	Flush mounting Non flush mounting	L1	L2	L3	L4	L5	Cable diameter	Body diameter (d)	Max switching frequency (F)	Rated operational current (I _e)	Nominal sensing distance (S _n) ± 10%	ORDERING REFERENCES	
		mm	mm	mm	mm	mm						mm	PNP (positive switching)
C-1	•	-	50	10	-	60	5	M18 x 1	100	400	2 ÷ 5		BKS18P/4629KS
C-1	•	-	40	10	-	60	5	M18 x 1	100	400	3 ÷ 10		BKS18P/5629KS
G-2	•	-	50	10	-	60	6	M30 x 1,5	100	400	3 ÷ 10		BKS30P/4629KS
G-2	•	-	35	10	-	60	6	M30 x 1,5	100	400	5 ÷ 20		BKS30P/5629KS
A-8	•	-	-	-	-	70	6	34	100	400	3 ÷ 20		BKS34P/5629KS
												NPN (negative switching) Use the above mentioned part number changing the last number 9 with 8 (ie. BKS18P/4628KS)	

Amplified in a.c. 2 wires •
 Diameters 18 - 30 mm •
 Cable output •

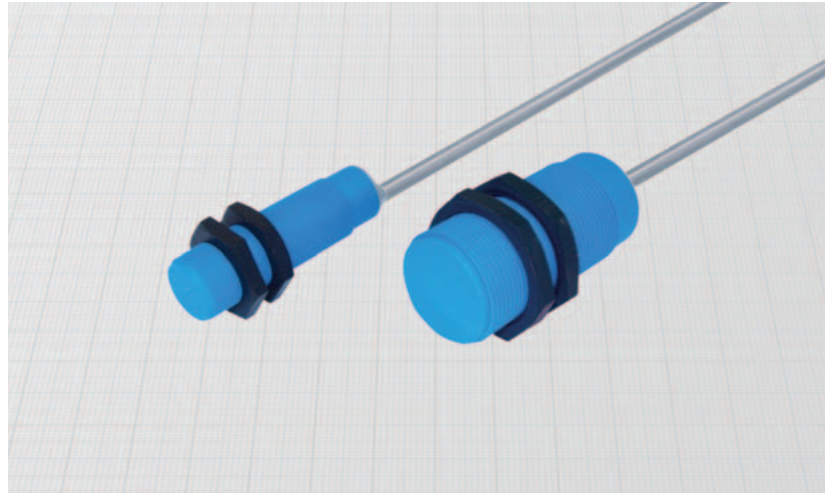
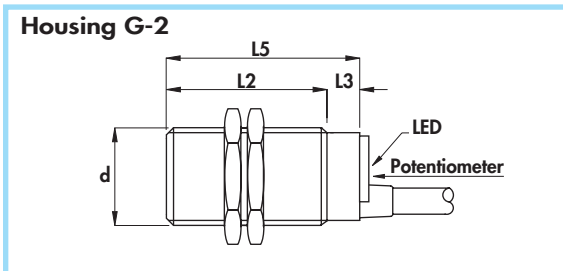
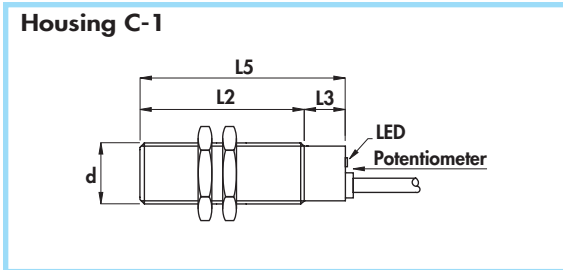

Diameter		M18 x 1	M30 x 1,5
Nut	Size	SW24	SW36
	Thickness mm	4	5
Max tightening torque Nm		5	20

Materials:

- Cable: 2 m PVC CEI 20 - 22 II; 90°C; 300 V; O.R.
- Housing: plastic
- Sensing face: plastic

General Features:

Capacitive sensors are suitable for any material detection. Some material, mostly if liquids, can be detected also through plastic or glass walls. They can be used for the most different applications: level controls on storage bin or tanks; detection of presence or filling of bottles; rain sensor; anti-vandalic key; etc.
 The adjustment of the sensing distance is possible through the potentiometer on the back cap close to the LED.

Technical data:

- Supply voltage (U_B): 20 ÷ 240 Vac
- Electrical system frequency: 40 ÷ 60 Hz
- Off-state current (I_o): ≤ 1,5 mA at 110 Vac
- Minimum operational current (I_m): 5 mA
- Voltage drop (U_d): ≤ 7 V
- Temperature range: - 25° ÷ + 70°C
- Max thermal drift of sensing distance S_r : ± 20%
- Repeat accuracy (R): 4%
- Switching hysteresis max (H): 15%
- Degree of protection: IP65
- Switch status indicator: yellow LED
- Cable conductor cross section: 0,50 mm² on 18 mm
0,75 mm² on 30 mm
- Suppression of initial false impulse
- Class 2 equipment according to IEC 536
- Shock and vibration according to EN60068-2-27 EN60068-2-6
- Electromagnetic compatibility (EMC) according to EN60947-5-2

Housing	Flush mounting Non flush mounting	L1	L2	L3	L4	L5	Cable diameter	Body diameter (d)	Max switching frequency (f)	Rated operational current (I _e)	Nominal sensing distance (S _n) ± 10%	ORDERING REFERENCES	
		mm	mm	mm	mm	mm							
C - 1	•	-	50	10	-	60	5	M18 x 1	10	250	2 ÷ 5	AKS18P/4609S	AKS18P/4619S
C - 1	•	-	50	10	-	60	5	M18 x 1	10	250	3 ÷ 10	AKS18P/5609S	AKS18P/5619S
G - 2	•	-	50	10	-	60	6	M30 x 1,5	10	250	3 ÷ 10	AKS30P/4609S	AKS30P/4619S
G - 2	•	-	50	10	-	60	6	M30 x 1,5	10	250	5 ÷ 20	AKS30P/5609S	AKS30P/5619S

RECTANGULAR CAPACITIVE SENSORS

- 5 Position head
- Amplified in d.c.
- Terminal block output

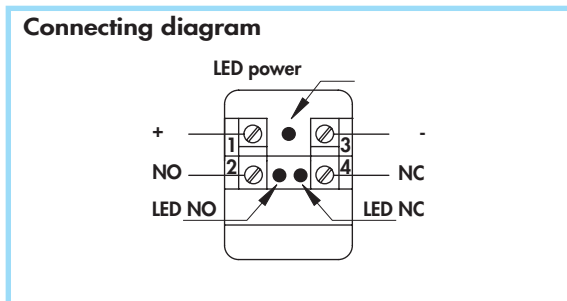
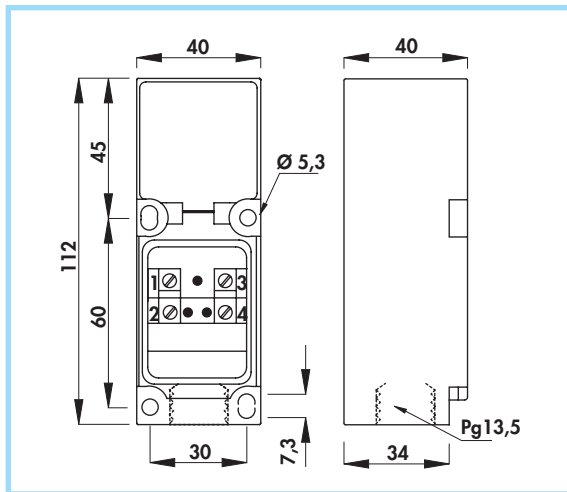

Materials:

- Housing: plastic
- Terminal block cover: polycarbonate

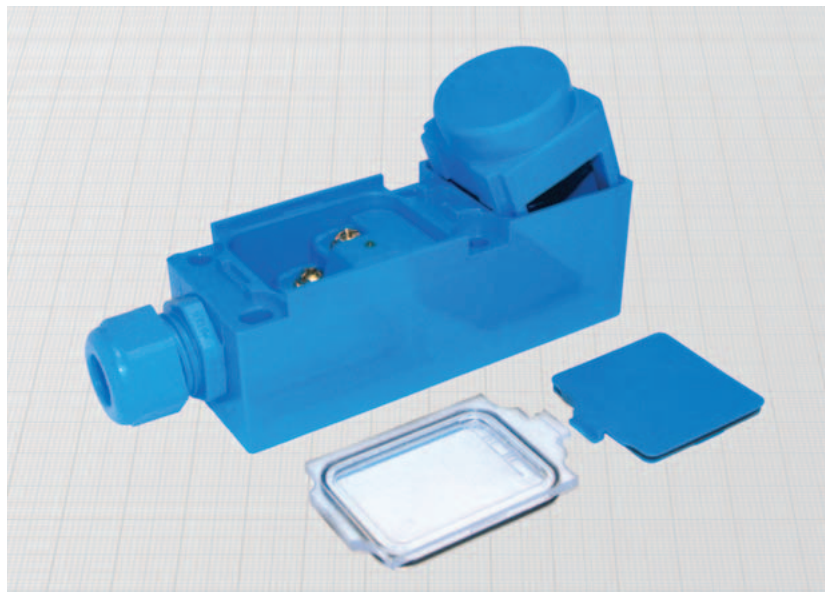

General Features:

These sensors are called "turnable sensing head" because the sensing head, inside the plastic housing can be positioned on 5 different positions. To choose the desired sensing face it is enough to remove the cover and set the sensing head in the proper position.

The internal terminal block can be easily reached by removing the transparent cover. Being capacitive, they are suitable for any material detection. Some material, mostly if liquids, can be detected also through plastic or glass walls. They can be used for the most different applications :

Level controls on storage bins or tanks; detection of presence or filling of bottles; rain sensor ; anti-vandalic key; etc...

The included plastic gland Pg13.5 is suited for cables diameter up to 9 mm.

Technical data:

- Supply voltage (U_B): 10 ÷ 60 Vdc
- Max ripple: 10%
- No-load supply current (I_0): ≤ 10 mA
- Voltage drop (U_d): ≤ 2,2 V
- Temperature range: -20° ÷ +70°C
- Max thermal drift of sensing distance S_p : ± 20%
- Repeat accuracy (R): 4%
- Switching hysteresis max (H): 15%
- Degree of protection with fully locked gland: IP65
- Status indicator: output n.o. yellow LED
output n.c. red LED
supply green LED

- Protected against short-circuit and overload
- Protected against any wrong connection
- Suppression of initial false impulse
- Electromagnetic compatibility (EMC) according to EN60947-5-2
- Shock and vibration resistance according to EN60068-2-27 EN60068-2-6

Flush mounting Non Flush mounting	Diameter zone sensible	Max switching frequency (f)	Rated operational current (I_e)	Nominal sensing distance (S_n) ± 10%	ORDERING REFERENCES
	mm	KHz	mA	mm	PNP (positive switching)
•	35	0,1	400	15	 BKSP/4729KS
					NPN (negative switching) Use the above mentioned part number changing the last number 9 with 8 (ie. BKSP/4728KS)



MAGNETIC SENSORS

The magnetic sensors range is basically made by two categories

DETECTION OF EXTERNAL MAGNETS

Very long sensing distance even with small sensors are possible. In order to choose properly the magnet see page C-12. In many cases the sensor is used to detect a magnet embedded inside other devices such as pneumatic cylinders, specifically made for this purpose.

There are two basic technologies : Reed contact or solid state.

Reed contact

They are the cheapest solution. Being made with the same production process as for the inductive sensors, they join the advantages of a robust and sealed construction to the electromechanical devices performances:

- no need of power supply
- no voltage drop
- no minimum load required
- no limitations in series and parallel connection

It must be observed that eventhough the number of cycles of a Reed contact is very high, that's not infinite. They are hence not suited for applications with high working frequency or requiring fast response time. It is also highly recommended to avoid to apply excessive mechanical strenght on the body of the sensors.

Working principle:

A Reed contact embedded inside the sensor detects the magnetic field and closes a contact able to drive directly the load. Versions with three wires or without LED don't have voltage drop on contacts. On the two wires with LED version you must consider a little voltage drop, to be considered for the series connection of more sensors.

Amplified in d.c. or static output

They are much more sensitive than the Reed contacts, as showed on page C-12 table.

They have all the advantages of the solid state sensors :

- Illimited number of cycles
- Very fast switching time
- High working frequencies
- High resistance against vibrations and mechanical strenght on the housing

Working principle:

An electronic, solid state component detects the magnetic field and drives amplifier stage, LED and short circuit protection.

DETECTION OF A FERROMAGNETIC TARGET

These sensors are able to detect only ferromagnetic objects. They are mainly used as selective sensors on working plants for aluminium, brass, copper, where bits of metal would create unavoided signals using standard inductive sensors.

Working principle:

An electronic, solid state component, internally polarized by an embedded magnet, detects the magnetic field variation due to the influence of an external ferromagnetic object, driving the amplifier, LED and short circuit protection.

MAGNETIC SENSORS CYLINDRICAL AND RECTANGULAR

BMS = activated by external magnet
DCH = activated by ferromagnetic target

Diameter of cylindrical sensors.
 For other types, change the number with the following:

Z = rectangular plastic 16 x 28 x 10
W = rectangular plastic 19 x 28,5 x 10,5

BMS	Z	/	4	6	0	9	KS	-5	PUR
------------	----------	----------	----------	----------	----------	----------	-----------	-----------	------------

3 = with connector M12 x 1
6 = standard type cable output
9 = with connector M8 x 1
***** = male connector cabled on sensor (see pag. H-1)

0 = NO (normally open output)
1 = NC (normally closed output)
2 = NO + NC (complementary outputs)

0 = REED contact
2 = REED contact 2-wire with LED
8 = NPN static output
2 = NPN static output open collector
9 = PNP static output
1 = PNP static output open collector

L = smooth body
J = degree of protection IP68
K = protection against short circuit and overload
S = LED output status
T = high temperatures version
P = high current REED contact

Cable length (if required different than standard 2m)

MAGNETIC SENSORS FOR PNEUMATIC CYLINDERS WITH T SLOT

BMT = activated by external magnet for pneumatic cylinders with T slot

BMT	2	0	3	F	1
------------	----------	----------	----------	----------	----------

1 = black color housing
2 = blue color housing

0 = NO (normally open output)
1 = NC (normally closed output)

2 = REED contact 2-wire with LED
3 = REED contact 3-wire
4 = REED contact 2-wire for high temperatures
8 = NPN static output
9 = PNP static output

- = PVC cable
R = PUR cable
F = PUR cable with M8 male connector with fixed nut (for 2-wire version connected on pins 1-4)
C = PUR cable with M8 male connector with fixed nut (2-wire version connected on pins 1-3)
N = PUR cable with M8 male connector with rotating nut
H = PUR cable with M12 male connector with rotating nut

Cable length (if required different than standard 2m)

- REED CONTACT 2 wires •**
Detection of magnets •
Cable output •

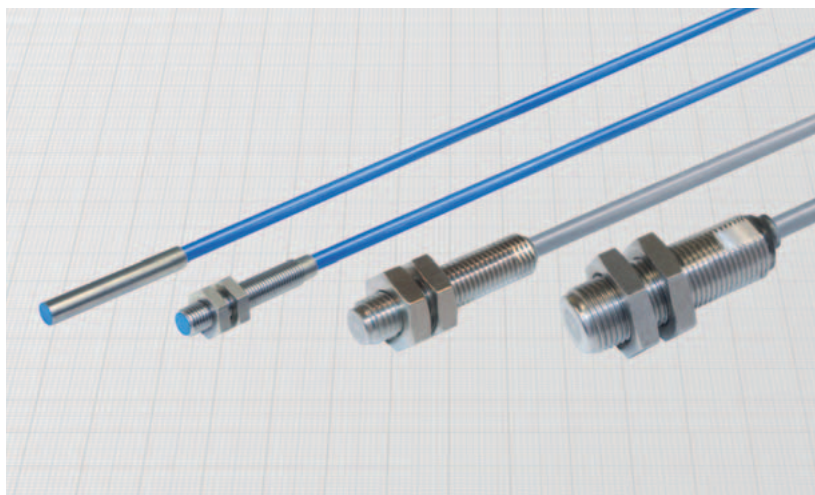
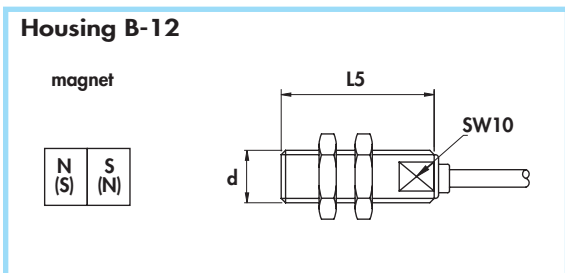
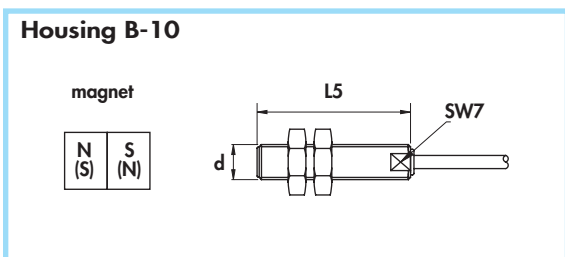
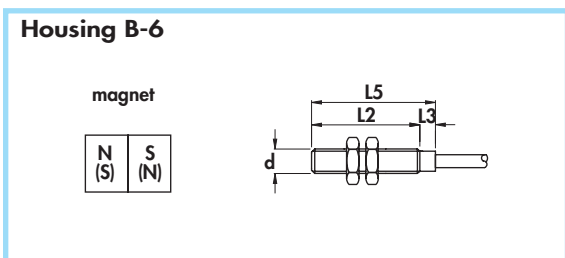
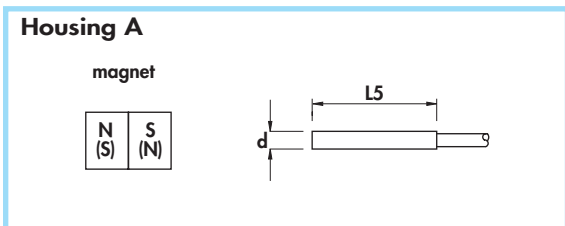

Diameter	M5 x 0,5	M8 x 1	M12 x 1
Nut	Size	SW7	SW13
	Thickness mm	2,5	4
Max tightening torque Nm	2	10	20

Materials:

- Cable: 2m PVC CEI 20 - 22 II; 90°C; 300 V; O.R.
- Housing: stainless steel

General Features:

These sensors give on the output a contact activated by an external magnetic field, not depending by the polarity of the field. The activation distance depends by the power of the magnet (see on page C-12), which must be ordered separately. Reed contacts allows to drive directly dc loads (PNP/NPN) or ac loads. Diameters 8 and 12 mm are completely in stainless steel and are able to withstand high pressures on the housing.

Technical data:

- Max working voltage: 50 Vac/75 Vdc normally open
- Output logic: 0,1 Ω
- Contact resistance max: 1 ms
- Operate time max: 0,4 ms
- Release time max: -25 ÷ + 85°C
- Temperature range: front side (diameters 8 and 12 mm): IP68
- Degree of protection: back side: IP67
- Pressure on the front side max (diameters 8 and 12 mm): 150 bar
- Cable conductor cross section: 0,15 mm² on 4 and 5 mm
- 0,35 mm² on 6,5 ÷ 12 mm

Housing	L1	L2	L3	L4	L5	Cable diameter	Body diameter (d)	Max switching frequency (f)	Rated operational current (I _e)	ORDERING REFERENCES
	mm	mm	mm	mm	mm					
A	-	-	-	-	25	3	4	0,5	500	BMS4/4600L
B-6	-	20	5	-	25	3	M5 x 0,5	0,5	500	BMS5/4600
A	-	-	-	-	30	4	6,5	0,5	500	BMS6,5/4600L
B-10	-	-	-	-	35	4	M8 x 1	0,5	500	BMS8/4600
B-12	-	-	-	-	35	4	M12 x 1	0,5	500	BMS12/4600

ORDERING REFERENCES

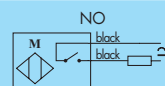

CYLINDRICAL MAGNETIC SENSORS IN METAL HOUSING

- REED CONTACT 2 and 3 wires with LED
- Detection of magnets
- Cable output

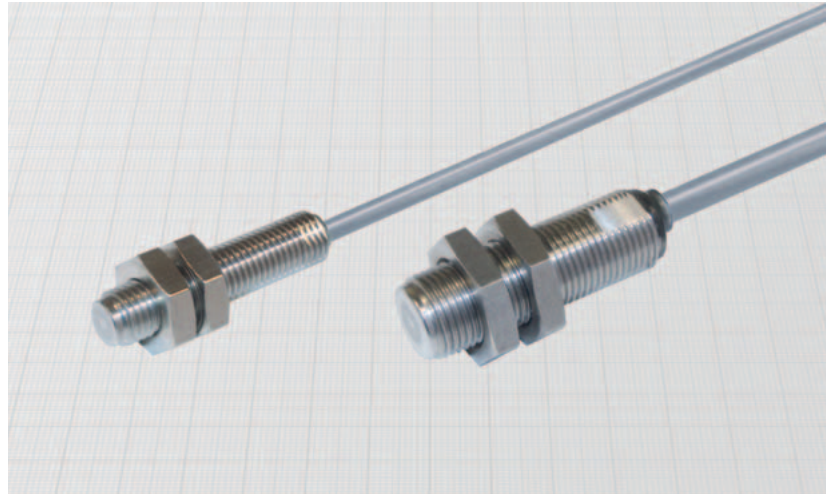
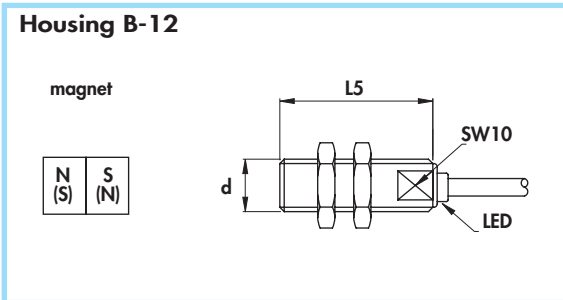
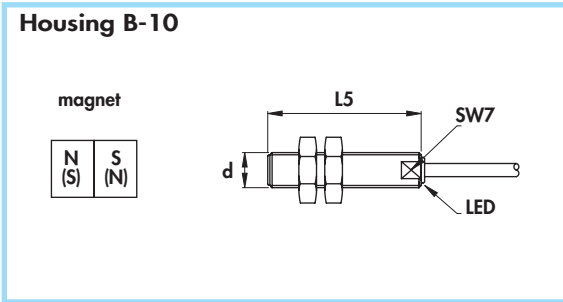

Diameter	M8 x 1	M12 x 1
Nut	Size	SW13
	Thickness mm	4
Max tightening torque Nm	10	20

Materials:

- Cable: 2m PVC CEI 20 - 22 II; 90°C; 300 V; O.R.
- Housing: stainless steel

General Features:

These sensors give on the output a contact activated by an external magnetic field, not depending by the polarity of the field. The activation distance depends by the power of the magnet (see on page C-12), which must be ordered separately. Reed contacts allows to drive directly dc loads (PNP/NPN) or ac loads. The output status is indicated by LED. The extremely strong construction allows the use in the most difficult conditions even with high pressures on the housing.

Technical data:

- Working voltage: 10 ÷ 30 Vac/Vdc
- Voltage drop (U_d) (2 wires versions) with I_e = 10 mA: ≤ 2,2 V
with I_e = 100 mA: ≤ 3 V
- Output logic: normally open
- Contact resistance max (3 wires versions): 0,1 Ω
- Operate time max: 1 ms
- Release time max: 0,4 ms
- Temperature range: - 25 ÷ + 85°C
- Degree of protection: front side: IP68
cable output side: IP67
- Max pressure on the front side: 150 bar
- Output status indication: yellow LED
- Cable conductor cross section: 0,22 mm² on 8 mm
0,34 mm² on 12 mm

Housing	L1	L2	L3	L4	L5	Cable diameter	Body diameter (d)	Max switching frequency (f)	Rated operational current (I _e)	ORDERING REFERENCES		
										PNP	NPN	2 wires
										NO brown black blue	NO blue black brown	NO black black
B-10	-	-	-	-	35	3,5	M8 x 1	0,5	500	BMS8/4600S BMS12/4600S	-	
B-12	-	-	-	-	35	4	M12 x 1	0,5	500		-	
B-10	-	-	-	-	35	4	M8 x 1	0,5	100	-	BMS8/4602S BMS12/4602S	
B-12	-	-	-	-	35	4	M12 x 1	0,5	100	-		

- Amplified in d.c. 3 wires with LED •
- Detection of magnets •
- Cable output •

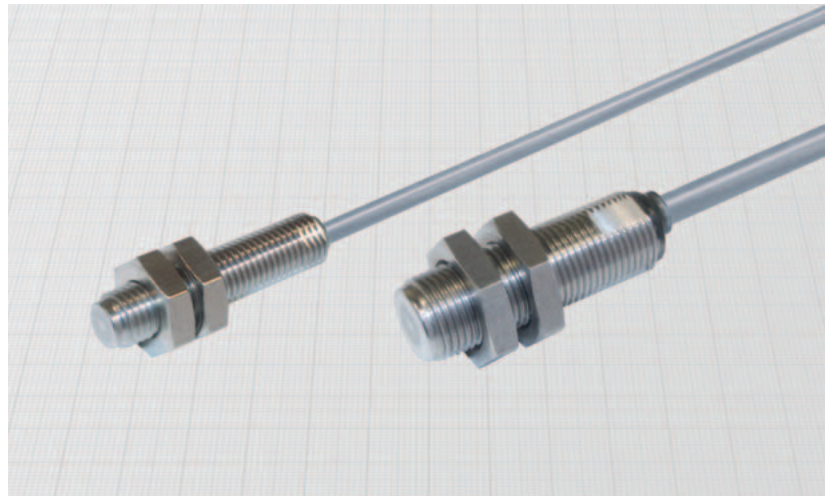
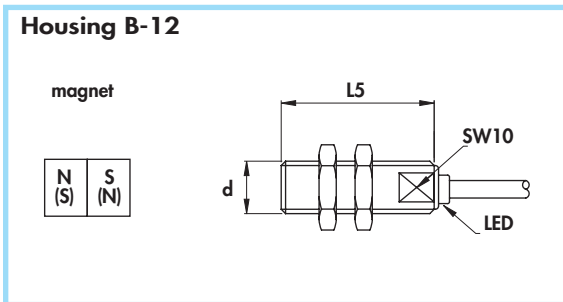
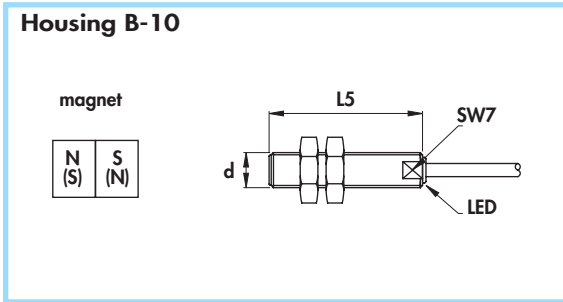

Diameter	M8 x 1	M12 x 1
Nut	Size	SW13
	Thickness mm	4
Max tightening torque Nm	10	20

Materials:

- Cable: 2m PVC CEI 20 - 22 II; 90°C; 300 V; O.R.
- Housing: stainless steel

General Features:

These sensors are completely electronic and are activated by an external magnetic field, not depending by the polarity of the field. The activation distance depends by the power of the magnet (see on page C-12), which must be ordered separately. Main advantages of static output sensors are unlimited electric life, protection against short circuit and lines transients, high switching frequency and no bounces on switching edges. The output status is indicated by LED. The extremely strong construction allows the use in the most difficult conditions even with high pressures on the housing.

Technical data:

- Supply voltage (U_B): 10 ÷ 30 Vdc
 - Max ripple: 10%
 - No-load supply current (I_0): < 20 mA
 - Voltage drop (U_d): ≤ 1.5 V
 - Repeat accuracy (R): < 2%
 - Temperature range: -25 ÷ + 85°C
 - Degree of protection: IP67
 - Max pressure on front side: 150 bar
 - Output status indicator: yellow LED
 - Cable conductor cross section: 0,22 mm² on 8 mm
0,34 mm² on 12 mm
- Protected against short-circuit and overload
 - Protected against any wrong connection
 - Suppression of initial false impulse
 - Electromagnetic compatibility (EMC) according to EN60947-5-2
 - Shock and vibration resistance according to EN60068-2-27 EN60068-2-6

Housing	L1	L2	L3	L4	L5	Cable diameter	Body diameter (d)	Max switching frequency (f)	Rated operational current (I _e)	ORDERING REFERENCES	
										PNP (positive switching)	
										NO	NC
B-10	-	-	-	-	35	3,5	M8 x 1	10	200		
B-12	-	-	-	-	35	4	M12 x 1	10	200	BMS8/4609KS	BMS8/4619KS
										BMS12/4609KS	BMS12/4619KS
NPN (negative switching)											
Use the above mentioned part number changing the last number 9 with 8 (ie. BMS8/4608KS)											

RECTANGULAR MAGNETIC SENSORS

- REED CONTACT 2 wires
- Type Z and W
- Cable output

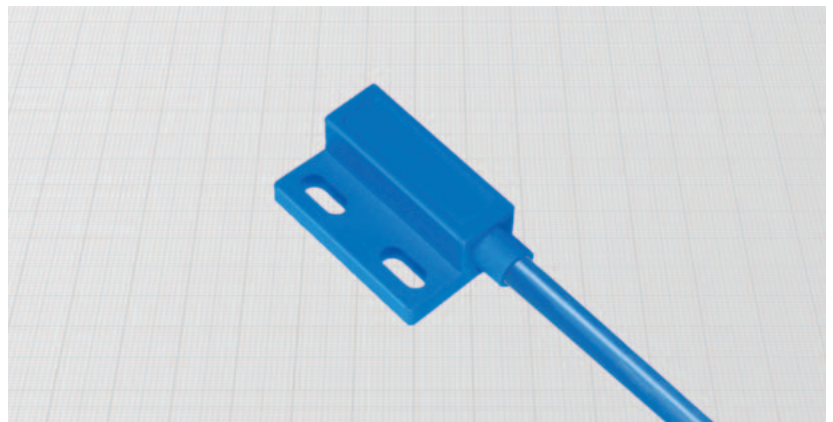
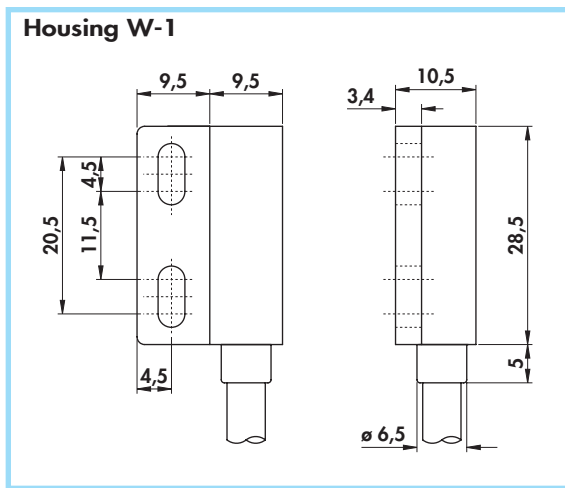
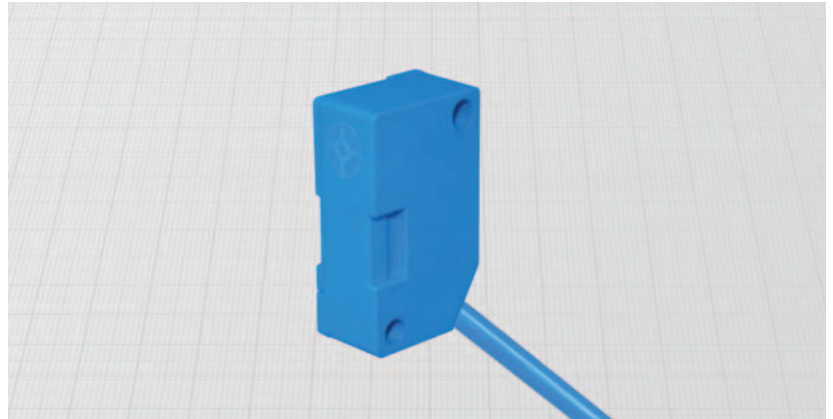
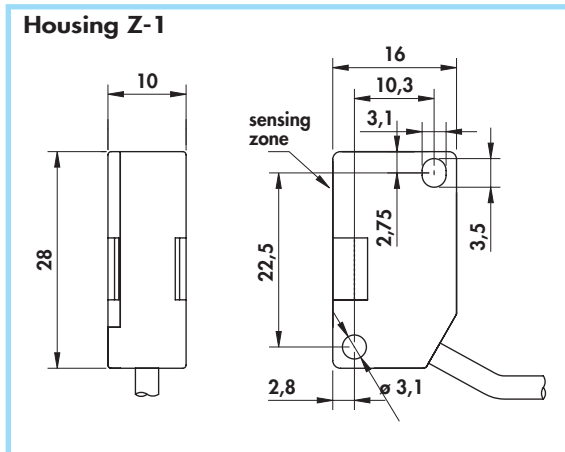

Materials:

- Cable: 2m PVC CEI 20 - 22 II; 90°C; 300 V; O.R.
- Housing: plastic

General Features:

These sensors give on the output a contact activated by an external magnetic field, not depending by the polarity of the field. The activation distance depends by the power of the magnet (see on page C-12), which must be ordered separately. Reed contacts allows to drive directly dc loads (PNP/NPN) or ac loads.

Technical data:

- Working voltage: max 50 Vac/75 Vdc
- Output function: normally open
- Contact resistance max: 0,1 Ω
- Operate time max: 1 ms
- Release time max: 0,4 ms
- Temperature range: -25 ÷ + 85°C
- Degree of protection: IP67
- Cable conductor cross section: 0,15 mm² Type Z
0,50 mm² Type W

Housing	Cable diameter	Max switching frequency (f ₁)	Rated operational current (I ₀)	ORDERING REFERENCES
	mm	KHz	mA	
Z - 1	3	0,5	500	BMSZ/4600
W - 1	5	0,5	500	BMSW/4600

Type Z and W - Amplified in d.c. 3 wires with LED •
 Detection of magnets •
 Cable output •

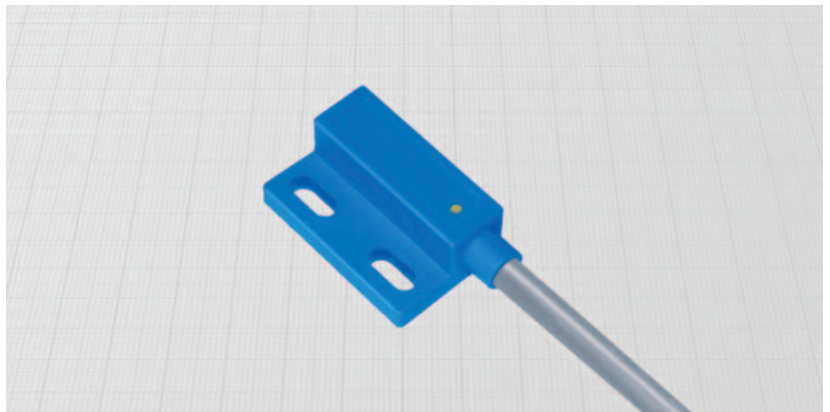
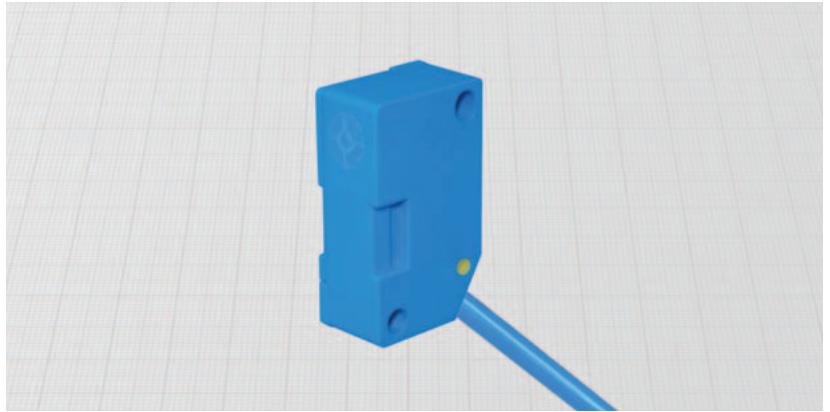
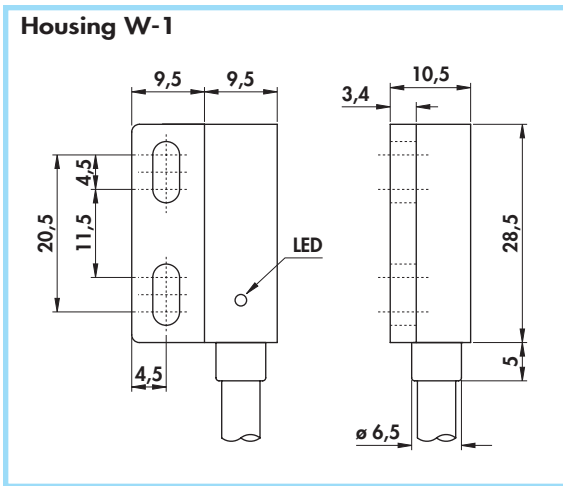
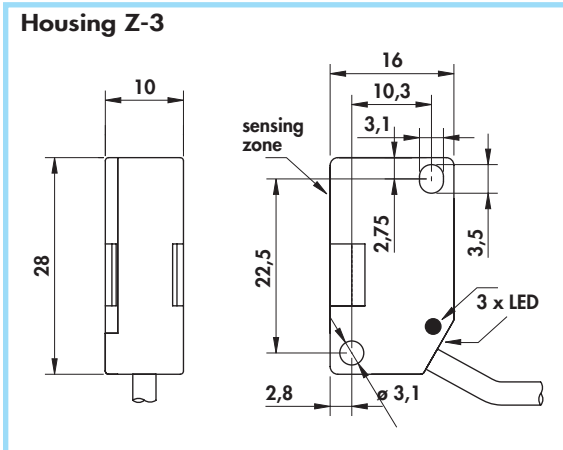

Materials:

- Cable: 2m PVC CEI 20 - 22 II; 90°C; 300 V; O.R.
- Housing: plastic

General Features:

These sensors are completely electronic and are activated by an external magnetic field, not depending by the polarity of the field. The activation distance depends by the power of the magnet (see on page C-12), which must be ordered separately. Main advantages of static output sensors are unlimited electric life, protection against short circuit and lines transient, high switching frequency and no bounces on switching edges. The output status is indicated by LED.

Technical data:

- Supply voltage (U_B): 10 ÷ 30 Vdc
- No-load supply current (I_0): < 20 mA
- Voltage drop (U_d): ≤ 1,5 V
- Repeat accuracy (R): < 2%
- Temperature range: - 25 ÷ + 85°C
- Degree of protection: IP67
- Switch status indicator: yellow LED
- Cable conductor cross section: 0,15 mm² Type Z
0,50 mm² Type W
- Protected against short-circuit, overload and any wrong connection
- Electromagnetic compatibility (EMC) according to EN60947-5-2
- Shock and vibration resistance according to EN60068-2-27 EN60068-2-6

Housing	Max ripple	Cable diameter	Max switching frequency (f)	Rated operational current (I _o)	ORDERING REFERENCES	
					PNP (positive switching)	
Z - 3	10	3	10	200		
W - 1	10	5	10	200	BMSZ/4609KS	BMSZ/4619KS
					BMSW/4609KS	BMSW/4619KS
NPN (negative switching)						
Use the above mentioned part number changing the last number 9 with 8 (ie. BMSZ/4608KS)						

RECTANGULAR MAGNETIC SENSORS

- REED CONTACT 2 and 3-wire with LED
- For pneumatic cylinders with T slot
- Drop-in mounting
- Cable and connector output M8 x 1 or M12 x 1

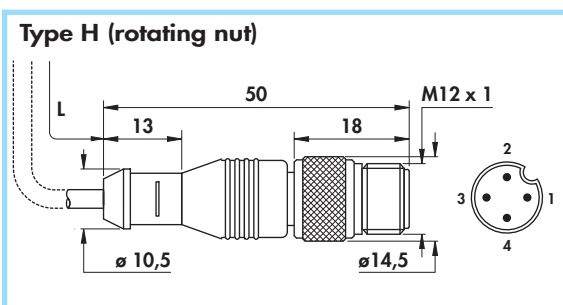
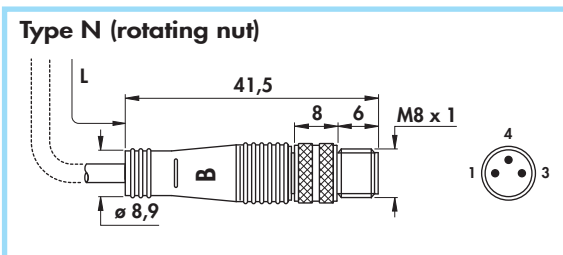
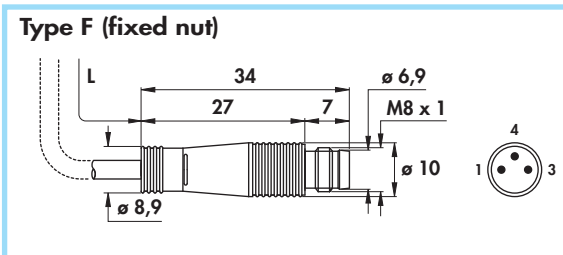
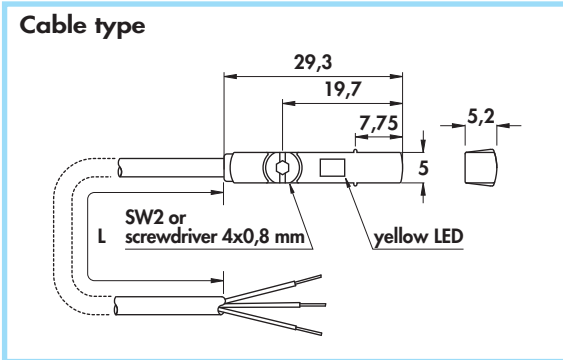

General Features:

This sensor detects the position of the magnetic ring inside a standard pneumatic cylinder with a T slot. The sensor remains completely recessed and thus mechanically protected. A clip to fix the cable inside the slot is supplied with the sensor. Reed contact provides for a direct driving of DC (PNP/NPN) and AC loads. A yellow LED gives indication of the output status. Available with cable exit, M8x1 connector or M12x1 connector.

Technical data:

- Working voltage: 10 ÷ 30 Vac/Vdc
- Output function: normally open
- Voltage drop (U_d) 2-wire versions:
 - with I_e = 10 mA ≤ 2,2 V
 - with I_e = 160 mA ≤ 3 V
- Contact resistance max (3-wire versions): 0,1 Ω
- Operate time max: 0,7 ms
- Release time max: 0,4 ms
- Temperature range: -25 ÷ + 85 °C
- Degree of protection: IP67
- Output status indication: yellow LED
- Cable conductor cross section: 0,15 mm²
- Electromagnetic compatibility (EMC) according to EN60947-5-2

Materials:

- Cable: BMT... PVC CEI 20-22 II; 90°C; 300V
- BMT...F; BMT...N; BMT...H; BMT...R PUR VDE 0492/265 90°C
- Sensor and fixing clip: plastic
- Rotating nut and fixing screw (*): nickel plated brass

(*) Stainless steel fixing screw available on request

Connection type	Female connector (see page H-1)	Cable diameter	Cable length (L)	Rated operational current (I _e)	Max switching frequency (f)	ORDERING REFERENCES		
						PNP (positive switching)	NPN (negative switching)	2-wire (*)
						n°	mm	m
cable	-	3	2	500	0,5			
F	11 - 12	3	0,3	500	0,5			
N	11 - 12	3	0,3	500	0,5			
H	8B - 10	3	0,3	500	0,5			
cable	-	3	2	100	0,5			
F	11 - 12	3	0,3	100	0,5			
N	11 - 12	3	0,3	100	0,5			
H	8B - 10	3	0,3	100	0,5			

Note: - different cable lengths must be specified at the end of the code. Ex: BMT203F1 for 1m of cable with connector.
 - for PUR cable add letter R at the end the code. Ex: BMT203R for 2m of PUR cable.
 - (**) for 2-wire version connected on pins 1-3 (brown-blue) use the code: BMT202C.

Amplified in d.c. 3-wire with LED •
 For pneumatic cylinders with T slot •
 Drop-in mounting •
 Cable and connector output M8 x 1 or M12 x 1 •

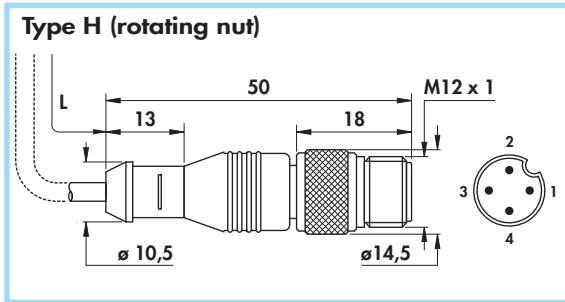
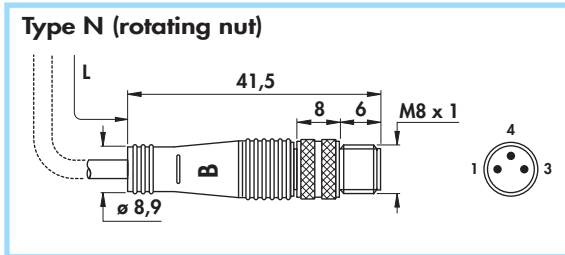
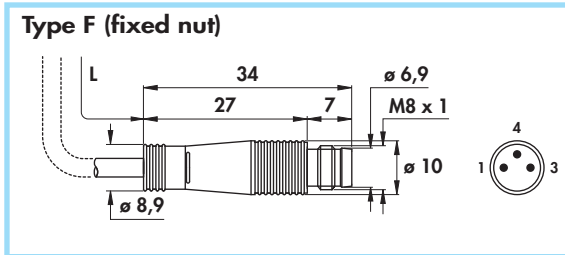
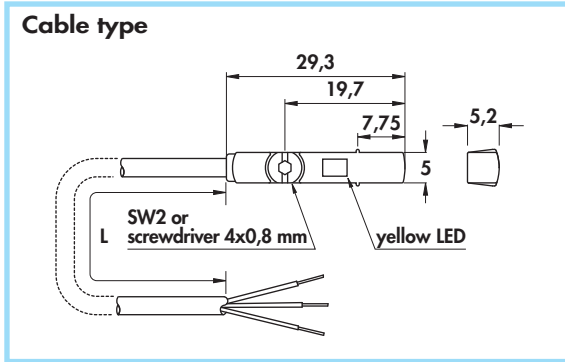

General Features:
 These sensors are completely electronic and detect the position of the magnetic ring inside a standard pneumatic cylinder with a T slot. The sensor remains completely recessed and thus mechanically protected. A clip to fix the cable inside the slot is supplied with the sensor. Main advantages of static output sensors are unlimited electric life, protection against short circuit and line transients, high switching frequency and no contact bounce. Version with output holding function available on request. A yellow LED gives indication of the output status. Available with cable exit, M8x1 connector or M12x1 connector.

Technical data:

- Supply voltage (U_B): 10 ÷ 30 Vdc
- No-load supply current (I_0): < 10 mA
- Temperature range: -25 ÷ + 85° C
- Degree of protection: IP67
- Switch status indicator: yellow LED
- Cable conductor cross section: 0,15 mm²
- Electromagnetic compatibility (EMC) according to EN60947-5-2
- Protected against short circuit, overload and connection mistakes
- Shock and vibration resistance according to EN60068-2-27 EN60068-2-6

Materials:

- Cable: BMT... PVC CEI 20-22 II; 90°C; 300V
- BMT...F; BMT...N; BMT...H; BMT...R PUR VDE 0492/265 90°C
- Sensor and fixing clip: plastic
- Rotating nut and fixing screw (*): nickel plated brass

(*) Stainless steel fixing screw available on request

Connection type	Female connector (see page H - 1)	Cable diameter	Cable length (L)	Max ripple	Max switching frequency (f)	Rated operational current (I _e)	ORDERING REFERENCES	
							PNP (positive switching)	
cable	-	3	2	10	10	200		
F	11-12	3	0,3	10	10	200	BMT209	BMT219
N	11-12	3	0,3	10	10	200	BMT209F	BMT219F
H	8B-10	3	0,3	10	10	200	BMT209N	BMT219N
							BMT209H	BMT219H

Note:
 - different cable lengths must be specified at the end of the code.
 Ex: BMT209F1 for 1m of cable with connector.
 - for PUR cable add letter R at the end of the code.
 Ex: BMT209R for 2m of PUR cable.

NPN (negative switching)
 Use the above mentioned part number changing the last number 9 with 8 (ie. BMT208)

--	--

• MAGNETS FOR SENSORS

Fig. A

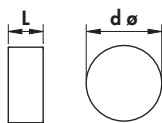

Fig. B

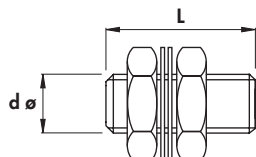

Fig. C

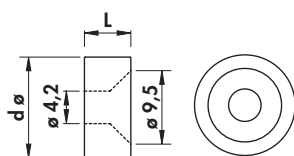
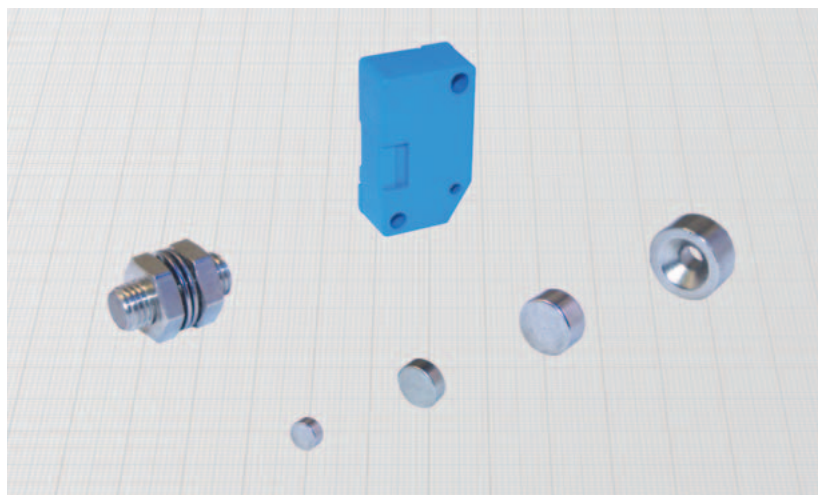
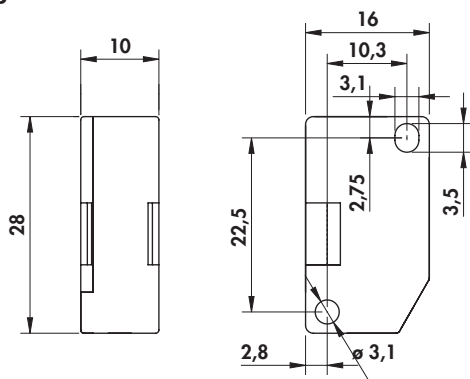

Fig. D



General Features:

These magnets can be used as actuator for all the magnetic sensors which need an external activation magnet. They're suitable for applications up to 70° C. For particular applications contact our technical office.

In the ordering reference table there are approximate detection distances obtained with different types of BDC sensors.

Fig.	Diameter	L	DETECTION DISTANCE		ORDERING REFERENCES
			With Reed sensors	With static sensors	
	mm	mm			
A	5	3	6	15	MAG-T53 MAG-T83 MAG-T105
A	8	3,6	13	22	
A	10	5	20	30	
B	M8x1	20	10	17	MAG-M820
C	13	6	25	45	MAG-TF136
D	-	-	13	22	MAG-Z

- Amplified in d.c. 3 and 4 wires
- Detection of ferromagnetic targets
- Connector output M12 x 1

Housing I-14

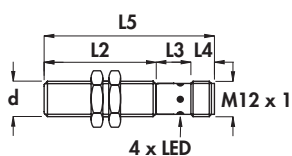

Housing I-13

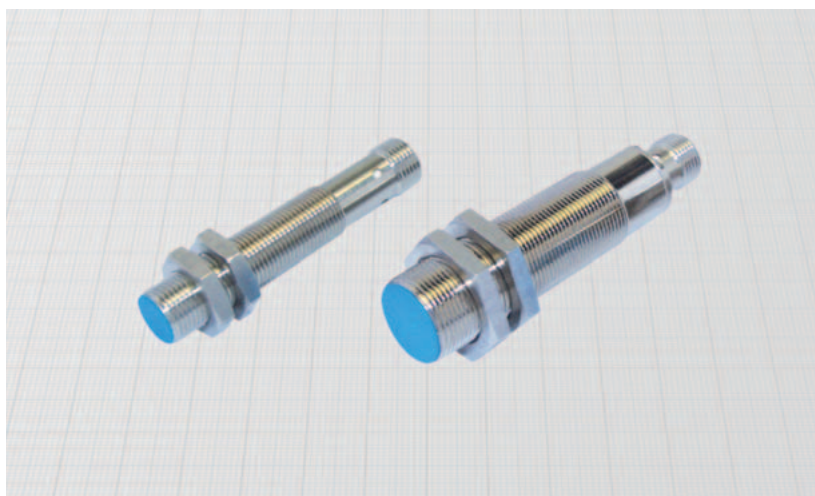
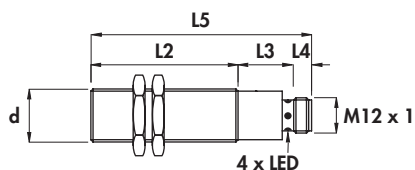

Diameter		M12 x 1	M18 x 1
Nut	Size	SW17	SW24
	Thickness mm	4	4
Max tightening torque Nm		15	35

Materials:

- Housing: nickel plated brass
- Sensing face: plastic

General Features:

These sensors are able to detect only ferromagnetic objects. They are mainly used as selective sensors on working plants for aluminium, brass, copper, where bits of metal would create unavoids signals using standard inductive sensors.

Technical data:

- Supply voltage (U_B): 10 ÷ 30 Vdc
- Max ripple: 10%
- No-load supply current (I_0): ≤ 20 mA
- Voltage drop (U_d): ≤ 1,5 V
- Temperature range: - 20° ÷ + 70°C
- Max thermal drift of sensing distance S_r : ± 10%
- Repeat accuracy (R): 2%
- Switching hysteresis max (H): 10%
- Degree of protection: IP67
- Switch status indicator: yellow LED
- Protected against short-circuit and overload
- Protected against any wrong connection
- Suppression of initial false impulse
- Electromagnetic compatibility (EMC) according to EN60947-5-2
- Shock and vibration resistance according to EN60068-2-27 EN60068-2-6

Housing	Mounting	L1	L2	L3	L4	L5	Female connector	Body diameter (d)	Max switching frequency (f)	Rated operational current (I _e)	Nominal sensing distance (S _n) ± 10% with Fe37	ORDERING REFERENCES		
												PNP (positive switching)		
	Flush mounting Non flush mounting	mm	mm	mm	mm	mm	n°	mm	KHz	mA	mm			
I-14	•	-	43	15	8	66	6-8B-10	M12 x 1	1	200	3	DCH12/4309KS	DCH12/43C9KS	DCH12/4329KS
I-13	•	-	50	19	8	77	6-8B-10	M18 x 1	1	200	3	DCH18/4309KS	DCH18/43C9KS	DCH18/4329KS
												NPN (negative switching)		
												Use the above mentioned part number changing the last number 9 with 8 (ie. DCH12/4308KS)		

SPEED SENSORS

- BRS** = for toothed wheels, single output, aligned mounting
- BRUS** = for toothed wheels, single output, non aligned mounting
- BRDS** = for toothed wheels, double output A+B, aligned mounting
- DSD** = with integrated control in d.c.
- ASD** = with integrated control in a.c.

Diameter

- X** = sensor with stainless steel housing

BRS	18	X/	4	6	0	9	KJ	-5
------------	-----------	-----------	----------	----------	----------	----------	-----------	-----------

- 3** = with connector M12 x 1
- 6** = standard type cable output
- *** = male connector cabled on sensor (see pag. H-1)

- 0** = 1 output
- 2** = 2 outputs A+B

- 8** = NPN
- 9** = PNP

- J** = degree of protection IP68
- K** = protection against short circuit and overload
- T** = high temperatures version
- S** = LED output status

Cable length (if required different than standard 2m)

- Aligned mounting •**
- For teeth ≥ 2 mm •**
- Cable output •**

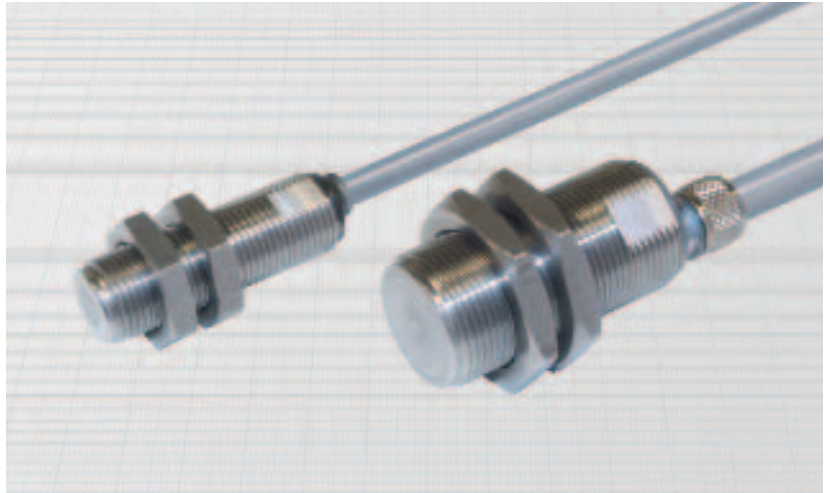
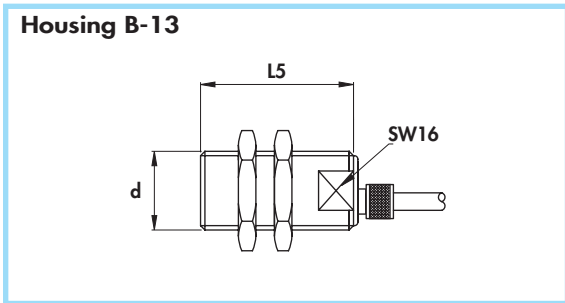
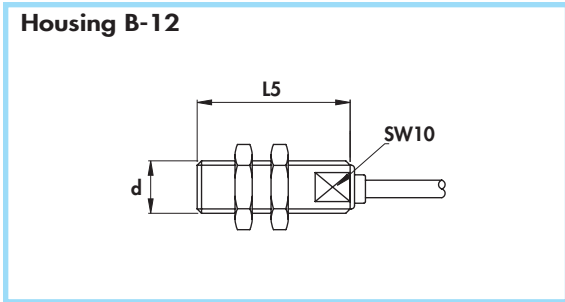

Diameter		M12 x 1	M18 x 1
Nut	Size	SW17	SW24
	Thickness mm	4	4
Max tightening torque Nm		20	50

- Materials:**
- Cable: 2 m thermoplastic, 300 V; O.R.
 - Housing: stainless steel
 - Back cap: plastic

Mounting and teeth dimension:

The sensor axis must be perpendicular to the rotation axis of the gear.
Flat faces must be parallel to the rotation plane of the gear.

Valley depth	ht	> 2 mm
Valley width	V	> 2 mm
Tooth width	T	> 2 mm
Gear thickness	F	> 3 mm
Operating distance	S	0 \pm 1,5 mm

General Features:
This sensor allows the detection with extremely high precision of the rotation of a ferrous toothed wheel and reference marks. The frequency of the digital output signal is proportional to the rotation speed starting from zero. The output is open collector. The extremely strong construction allows the use in the most difficult conditions even with high pressures on the housing. The sensor must be aligned to the rotation axis of the wheel.

- Technical data:**
- Supply voltage (U_B): 8 \div 30 Vdc
 - No-load supply current (I_o): \leq 20 mA
 - Voltage drop (U_d): \leq 0,6 V
 - Temperature range: - 40 \div +120°C
 - Degree of protection: IP68
 - Max pressure on front side: 150 bar
 - Protected against short-circuit and overload
 - Protected against any wrong connection
 - Electromagnetic compatibility (EMC) according to EN60947-5-2
 - Shock and vibration resistance according to EN60068-2-27 EN60068-2-6
 - Cable conductor cross section: 0,35 mm² on 12 mm
0,50 mm² on 18 mm

Housing	L1	L2	L3	L4	L5	Cable diameter	Body diameter (d)	Max switching frequency (f)	Rated operational current (I _e)	ORDERING REFERENCES			
										PNP		NPN	
B-12	-	-	-	-	35	4	M12 x 1	20	80	BRS12X/4609KJ	BRS12X/4608KJ		
B-13	-	-	-	-	35	5	M18 x 1	20	80	BRS18X/4609KJ	BRS18X/4608KJ		

SPEED SENSORS FOR TOOTHED WHEELS

- Non aligned mounting
- For teeth ≥ 5 mm
- Cable output

Housing B-12

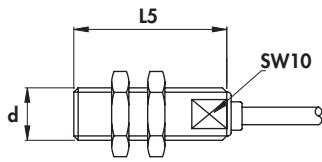

Housing B-13

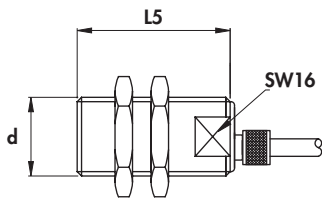

Diameter	M12 x 1	M18 x 1
Nut	Size	SW17
	Thickness mm	4
Max tightening torque Nm	20	50

Materials:

- Cable: 2 m thermoplastic, 300 V; O.R.
- Housing: stainless steel
- Back cap: plastic

Mounting and teeth dimension

The sensor axis must be perpendicular to the rotation axis of the gear. Flat faces can be at any position respect the rotation plane of the gear.

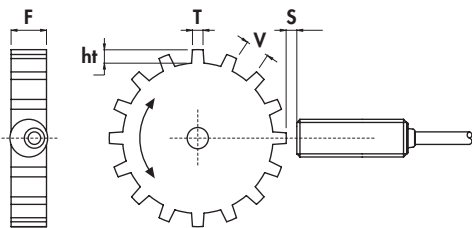

Valley depth	ht	≥ 5 mm
Valley width	V	≥ 13 mm
Tooth width	T	≥ 5 mm
Gear tickness	F	≥ 5 mm
Operating distance	S	$0 \pm 1,5$ mm

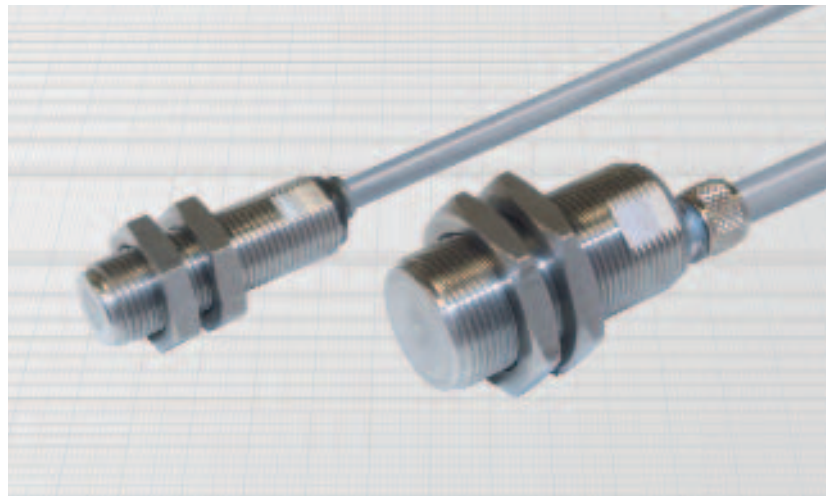

General Features:

This sensor allows the detection with extremely high precision of the rotation of a ferrous toothed wheel and reference marks. Since it detects even frontal approaching of the target, it can be used as proximity switch. The frequency of the digital output signal is proportional to the rotation speed starting from zero. The output is open collector. The extremely strong construction allows the use in the most difficult conditions even with high pressures on the housing. The sensor does not require any alignment to the rotation axis of the wheel.

Technical data:

- Supply voltage (U_B): $8 \div 30$ Vdc
- No-load supply current (I_0): ≤ 16 mA
- Voltage drop (U_d): $\leq 0,6$ V
- Temperature range: $-40^\circ \div +120^\circ$ C
- Degree of protection: IP68
- Max pressure on front side: 150 bar
- Protected against short-circuit and overload
- Protected against any wrong connection
- Electromagnetic compatibility (EMC) according to EN60947-5-2
- Shock and vibration resistance according to EN60068-2-27 EN60068-2-6
- Cable conductor cross section: $0,35$ mm² on 12 mm, $0,50$ mm² on 18 mm

Housing	L1	L2	L3	L4	L5	Cable diameter	Body diameter (d)	Max switching frequency (f)	Rated operational current (I _e)	ORDERING REFERENCES			
										PNP		NPN	
B-12	-	-	-	-	35	4	M12 x 1	25	80	BRUS12X/4609KJ	BRUS12X/4608KJ		
B-13	-	-	-	-	35	5	M18 x 1	25	80	BRUS18X/4609KJ	BRUS18X/4608KJ		

Double output A + B •

Cable output •

Housing B-12

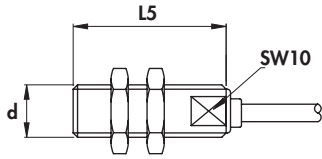

Housing B-13

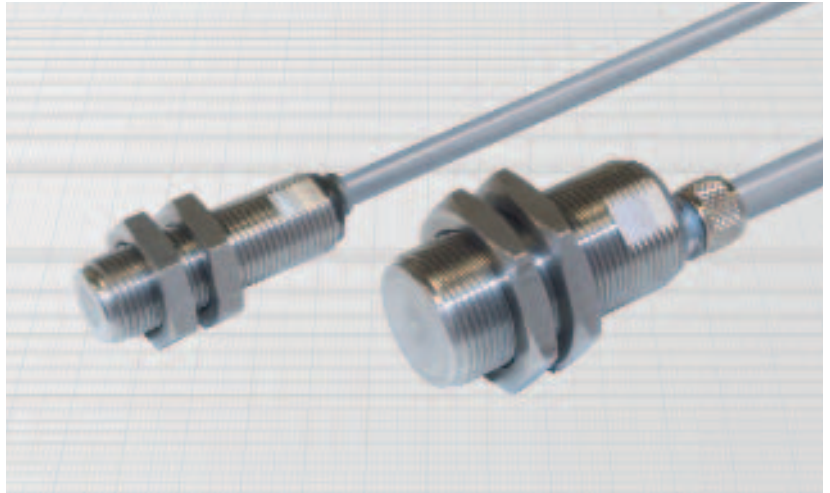
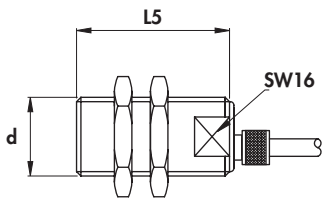

Diameter	M12 x 1	M18 x 1
Nut	Size	SW17
	Thickness mm	4
Max tightening torque Nm	20	50

Materials:

- Cable: 2 m thermoplastic, 300 V; O.R.
- Housing: stainless steel
- Back cap: plastic

Mounting and teeth dimension

The sensor axis must be perpendicular to the rotation axis of the gear. Flat faces must be parallel to the rotation plane of the gear.

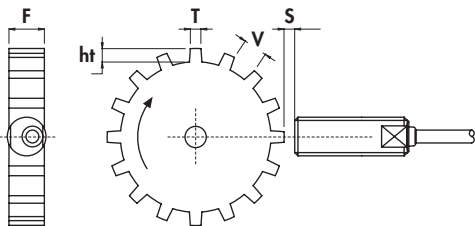

Valley depth	ht	≥ 2 mm
Valley width	V	≥ 2 mm
Tooth width	T	≥ 2 mm
Gear tickness	F	≥ 6 mm
Operating distance	S	0 ÷ 1 mm

General Features:

This sensor gives two separated signals shifted which allow to detect not only the rotation speed but also the direction of a ferrous toothed wheel or reference marks. The frequencies of the digital output signals are proportional to the rotation speed starting from zero. The outputs are NPN open collector. The extremely strong construction allows the use in the most difficult conditions even with high pressures on the housing. The sensor must be aligned to the rotation axis of the wheel.

Technical data:

- Supply voltage: 5 ÷ 25 Vdc
- No load supply current: ≤ 21 mA
- Voltage drop (I_o = 10mA): ≤ 0,4 V
- Temperature range: - 40 ÷ +120°C
- Degree of protection: IP68
- Max pressure on front side: 150 bar
- Protected against short-circuit and overload
- Protected against any wrong connection
- Electromagnetic compatibility (EMC) according to EN60947-5-2
- Shock and vibration resistance according to EN60068-2-27 EN60068-2-6
- Cable conductor cross section: 0,25 mm²

Output Signals

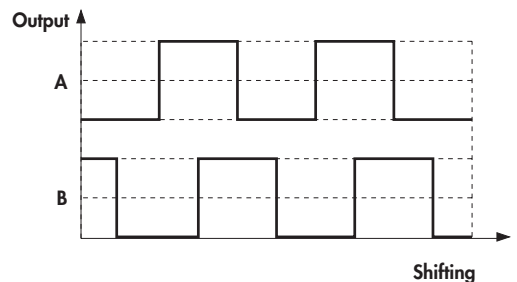

Housing	L1	L2	L3	L4	L5	Cable diameter	Body diameter (d)	Max switching frequency (f)	Rated operational current (I _o)	ORDERING REFERENCES	
	mm	mm	mm	mm	mm					mm	mm
B-12	-	-	-	-	35	4	M12 x 1	6	20	BRDS12X/4628KJ	
B-13	-	-	-	-	35	5	M18 x 1	6	20	BRDS18X/4628KJ	

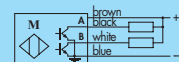

SPEED SENSORS

- Speed sensors with integrated control
- 3 wires - d.c.
- Connector output M12 x 1

Housing I-11

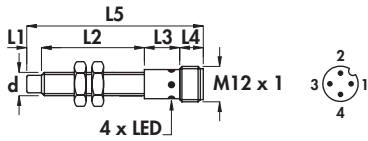

Housing I-7

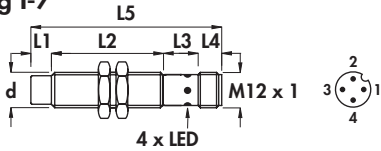

Housing I-12

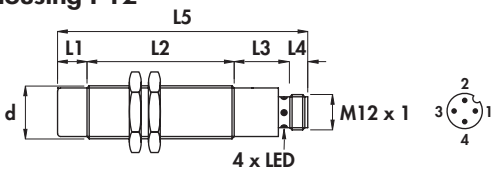

Housing I-2

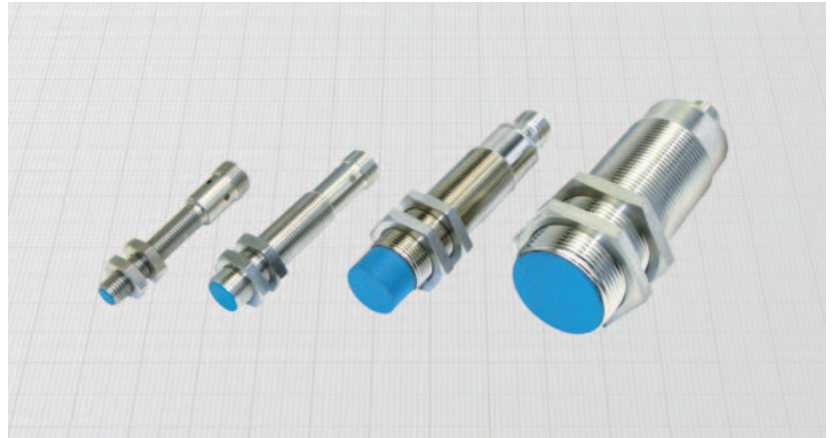
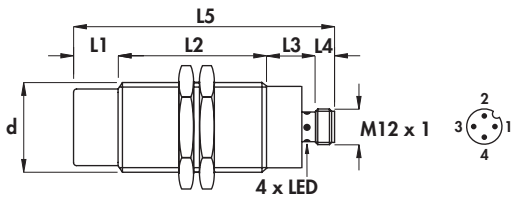

General Features:

These sensors allow to control with extremely high precision the rotation of a toothed wheel or reference marks, switching off the load or giving an alarm in case the speed goes down the minimum threshold. Thanks to the extremely wide measuring range they can be even used to control repetitive operations, signalling in case of unavoids stops. Further delays or other special functions are implementable upon specific request.

The output is protected against connection mistakes, overvoltages on lines, and short circuit of the load. The connection is possible with a 4 wires M12x1 connector which must be ordered separately.

Technical data:

- Working voltage: 10 ÷ 30 Vdc
- Max ripple: 10%
- No-load supply current: < 15 mA
- Voltage drop: < 1,5 V
- Switching hysteresis (H): < 10% Sn
- Repeat accuracy (R): < 2% Sn
- Maximum detectable interval (between two pulses): 2 min
- Detectable start-up time (T1): 0 ÷ 1 min (default 2 sec.)
- Temperature range: -20 ÷ +70°C
- Max thermal drift of sensing distance S_n : ±10%
- Degree of protection: IP67
- Status indicator: yellow LED = out ON; frequency over the threshold
- Protected against short-circuit and overload
- Electromagnetic compatibility (EMC) according to EN60947-5-2
- Shock and vibration resistance according to EN60068-2-27 e EN60068-2-6

Diameter	M8 x 1	M12 x 1	M18 x 1	M30 x 1,5
Nut	Size	SW13	SW17	SW24
	Thickness mm	4	4	4
Max tightening torque Nm	10	15	35	80

Materials:

- Housing 8 mm: stainless steel
- Housing 12 - 18 - 30 mm: nickel plated brass
- Sensing face: plastic

Housing	Flush mounting Non flush mounting	L1	L2	L3	L4	L5	Female connector (see page I-1)	Body diameter (d)	Max detectable frequency	Nominal sensing distance (S_n) ±10%	ORDERING REFERENCES	
											PNP (positive switching)	
I-11	•	-	40	12	8	60	6-8B-10	M8 x 1	1	1,5	DSD8/4309KS	
I-11	•	5	35	12	8	60	6-8B-10	M8 x 1	1	2,5	DSD8/5309KS	
I-7	•	-	43	15	8	66	6-8B-10	M12 x 1	1	2	DSD12/4309KS	
I-7	•	7	36	15	8	66	6-8B-10	M12 x 1	1	4	DSD12/5309KS	
I-12	•	-	50	19	8	77	6-8B-10	M18 x 1	1	5	DSD18/4309KS	
I-12	•	10	50	19	8	87	6-8B-10	M18 x 1	1	8	DSD18/5309KS	
I-2	•	-	65	17	8	90	6-8B-10	M30 x 1,5	0,8	10	DSD30/4309KS	
I-2	•	15	50	17	8	90	6-8B-10	M30 x 1,5	0,4	15	DSD30/5309KS	

Example of application

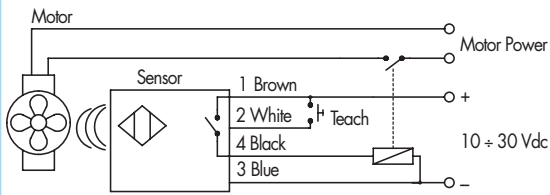

Use of the sensor:

On power on, the yellow LED goes on and the output switches in ON state, driving the relay, which will drive the motor. After a start up delay time (T1) the sensor measures the speed of the motor and compare it to the threshold value. If the speed is under the threshold value, the output goes OFF, turning off the LED. The minimum threshold can be either factory presetted or can be acquired from the sensor directly on the application with no need to perform any measurement.

Procedure 1

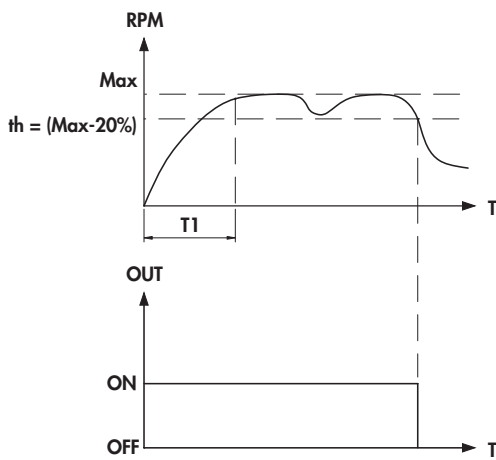

Threshold self-teaching procedure:

There are two different ways to perform the self-teaching of the threshold:

1 - Acquisition of start up time and calculation of the threshold from the maximum speed:

- a) connect the Teach input (white) to the positive of power supply (brown) before to turn on the power
- b) Turn on the power supply to the machine and to the sensor and wait the speed gets the nominal value
- c) Turn off the power supply
- d) At this stage the sensor acquired the start up time (T1) and calculated the threshold as the maximum value of the speed reduced of -20%
- e) Disconnect the Teach in from the positive of power supply before to run the machine again.

Procedure 2

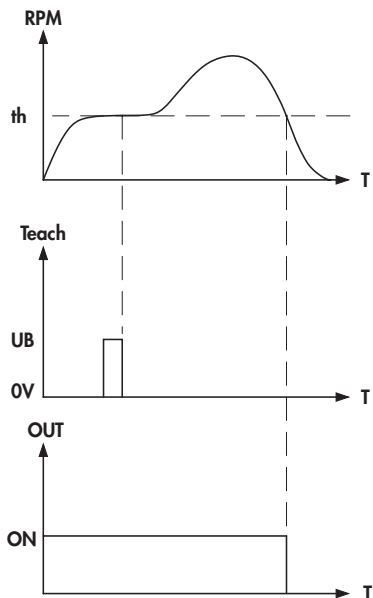

2 - Acquisition of a known threshold (start up time is not modified):

- a) Turn the power supply on to the machine and sensor and go to the speed you want to get as threshold (th)
- b) Connect temporarily the Teach input (white) to the positive of power supply. This operation can be easily done with a push-button on the operator panel of the machine.
- c) At this stage the current speed becomes the minimum threshold (th), under of which the sensor goes in OFF state.

Both of the procedures can be repeated unlimited times.

SPEED SENSORS

- Speed sensors with integrated control
- 2 wires - a.c.
- Cable output

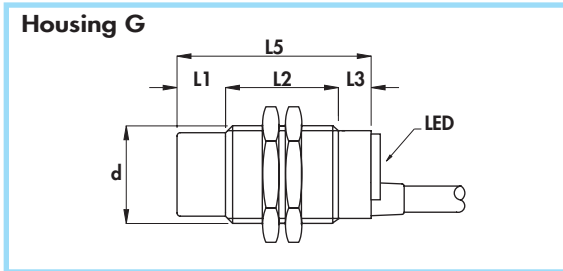
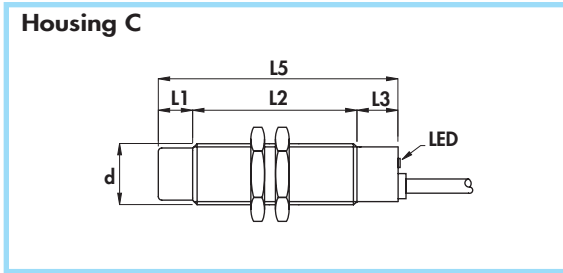

Diameter		M18 x 1	M30 x 1,5
Nut	Size	SW24	SW36
	Thickness mm	4	5
Max tightening torque Nm		35	80

Materials:

- Cable: 2m PVC - CEI 2022 II- 90°C 300V-O.R.
- Housing: nickel plated brass
- Sensing face: plastic

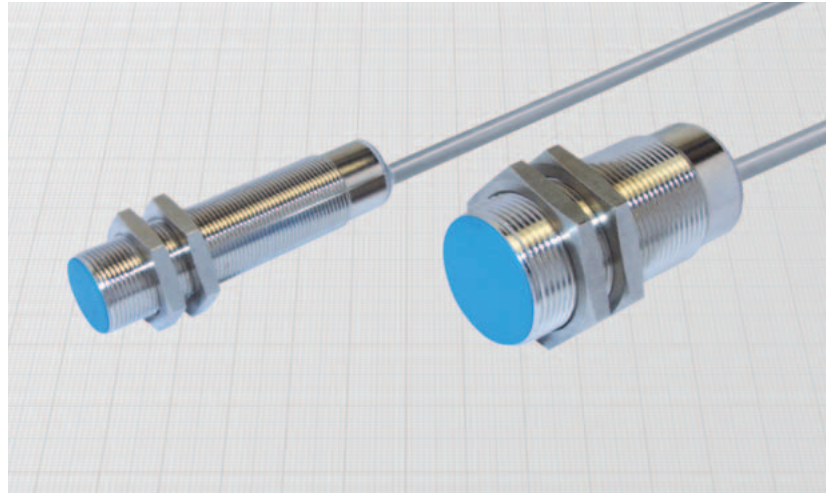

General Features:

These sensors allow to control with extremely high precision the rotation of a toothed wheel or reference marks, switching off the load in case of the speed goes down the minimum threshold. Thanks to the extremely wide measuring range they can be even used to control repetitive operations, signalling in case of unavoided stops. They are able to drive directly a.c. relais from 90 to 240 Vac with no need of external power supply or amplifiers.

Further delays or other special functions are implementable upon specific request. The output is protected against connection mistakes, overvoltages on lines, and short circuit of the load.

Technical data:

- Working voltage: 90 ÷ 240 Vac
- Electrical system frequency: 40 ÷ 60 Hz
- Off-state current at 220 V: <2,2 mA
- Minimum operational current: 8 mA
- Rated operational current: 200 mA
- Voltage drop: <8V
- Switching hysteresis (H): < 10% S_n
- Repeat accuracy (R): < 2% S_n
- Maximum detectable interval (between two pulses): 2 min
- Detectable start-up time (T1): 0 ÷ 1 min (default 2 sec.)
- Temperature range: -20 ÷ +70°C
- Max thermal drift of sensing distance S_n: ±10%
- Degree of protection: IP67
- Cable conductor cross section: 0,50mm²
- Status indicator: yellow LED = out ON; frequency over the threshold
red LED = out OFF; frequency under the threshold
blinking red LED = out OFF; short circuit on the output
- Protected against short-circuit and overload
- Class 2 equipment according to IEC 536
- Shock and vibration according to EN60068-2-27 EN60068-2-6
- Electromagnetic compatibility (EMC) according to EN60947-5-2

Housing	Flush mounting Non flush mounting	L1	L2	L3	L4	L5	Cable diameter	Body diameter (d)	Max detectable frequency	Rated operational current (I _e)	Nominal sensing distance (S _n) ± 10%	ORDERING REFERENCES
		mm	mm	mm	mm	mm						
C	•	-	58	12	-	70	5	M18 x 1	800	200	5	ASD18/4609KS ASD18/5609KS
C	•	10	48	12	-	70	5	M18 x 1	400	200	8	
G	•	-	50	10	-	60	6	M30 x 1,5	400	200	10	ASD30/4609KS ASD30/5609KS
G	•	15	35	10	-	60	6	M30 x 1,5	200	200	15	

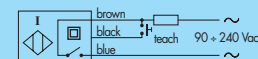

Example of application

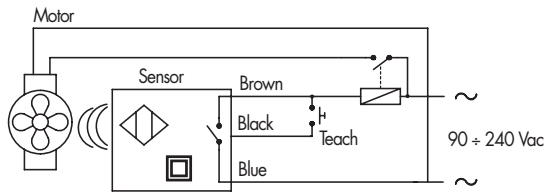

Use of the sensor:

On power on, the yellow LED goes on and the output switches in ON state, driving the relay, which will drive the motor. After a start up delay time (T1) the sensor measures the speed of the motor and compares it to the threshold value. If the speed is under the threshold value, the output goes OFF, giving an alarm indication with the red LED. The minimum threshold can be either factory presetted or can be acquired from the sensor directly on the application with no need to perform any measurement.

Procedure 1

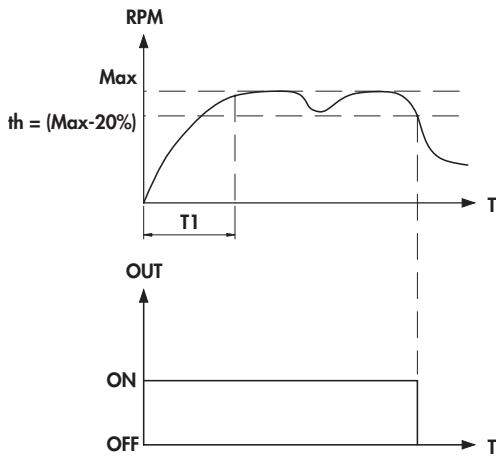

Threshold self-teaching procedure:

There are two different ways to perform the self-teaching of the threshold:

1 - Acquisition of start up time and calculation of the threshold from the maximum speed:

- a) connect the Teach input (black) to the brown before to turn on the power
- b) Turn on the power supply to the machine and to the sensor and wait the speed gets the nominal value
- c) Turn off the power supply
- d) At this stage the sensor acquired the start up time (T1) and calculated the threshold as the maximum value of the speed reduced of -20%
- e) Disconnect the Teach in from the brown wire before to run the machine again.

2 - Acquisition of a known threshold (start up time is not modified):

- a) Turn the power supply on to the machine and sensor and go to the speed you want to get as threshold (th).
- b) Connect temporarily the Teach input (black) to the brown wire. This operation can be easily done with a push-button on the operator panel of the machine.
- c) At this stage the current speed becomes the minimum threshold (th), under of which the sensor goes in OFF state.

Both of the procedures can be repeated unlimited times.

Procedure 2

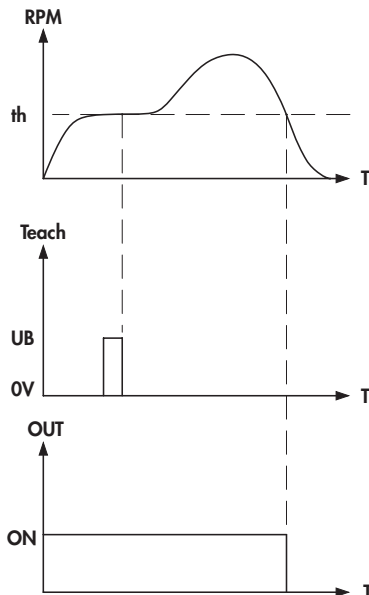

ACCELERATION SENSORS

Acceleration is a physical quantity related to any event of motion, rotation, vibration and inclination. Monitoring accelerations is an optimal way to gather reliable information on working process. Generally these information cannot be easily obtained by other sensor systems.

This kind of information is useful to make reliable automatic control diagnostic and supervision systems.

Accelerometers are inertial sensors that supply proportional electrical signal to accelerations applied to the device in specific directions.

Signal analysis and calculations are performed internally by the sensor, not requiring then external additional modules or software. The application is therefore very simple.

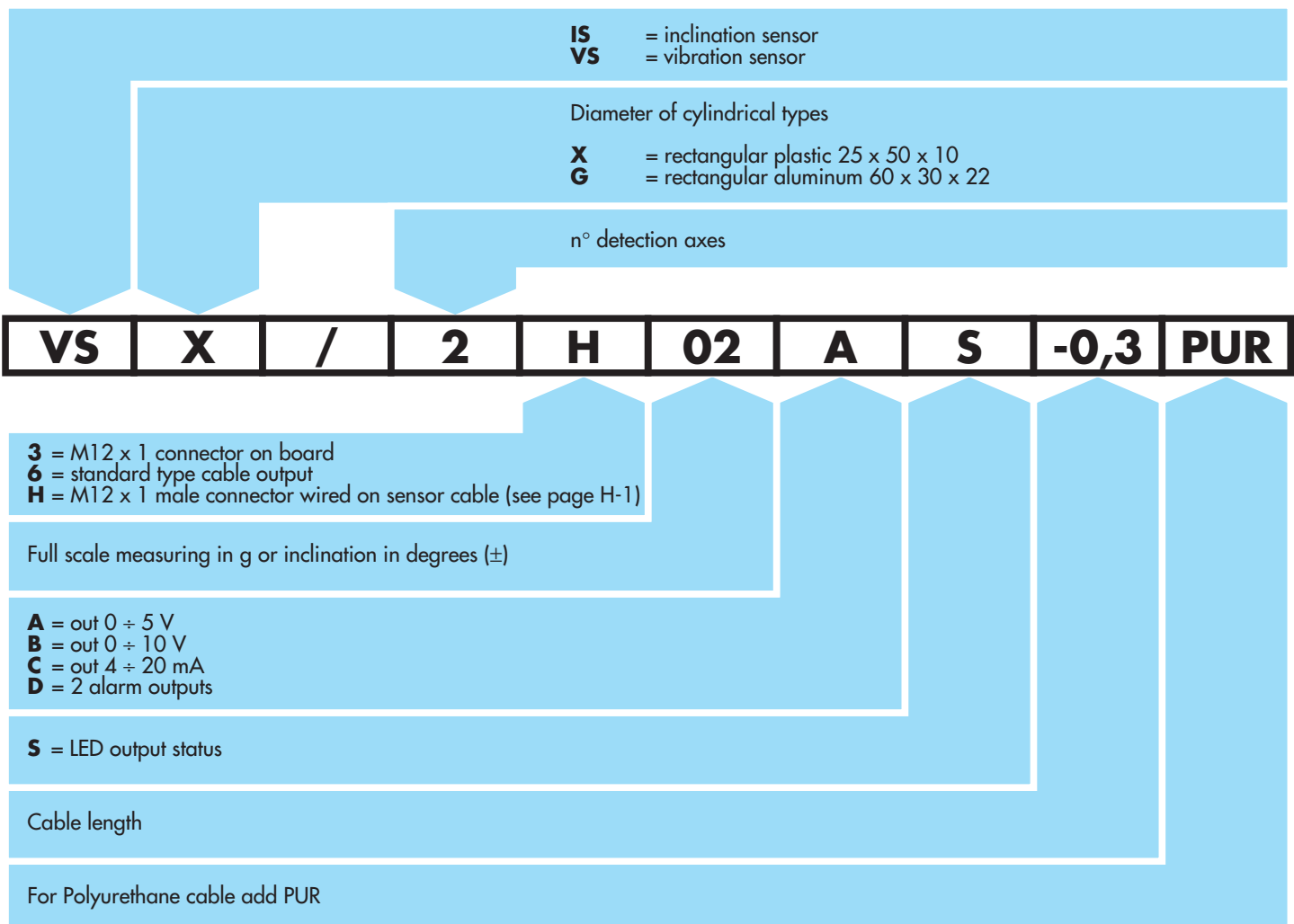

2 AXIS INCLINATION SENSORS (-60° ÷ + 60°) •
Analog linear output •
Cable output •

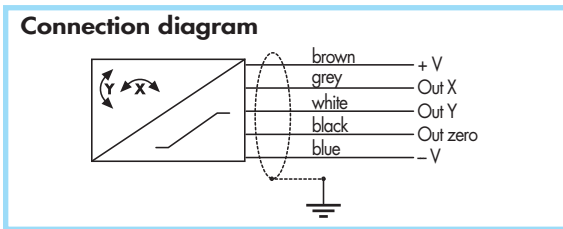
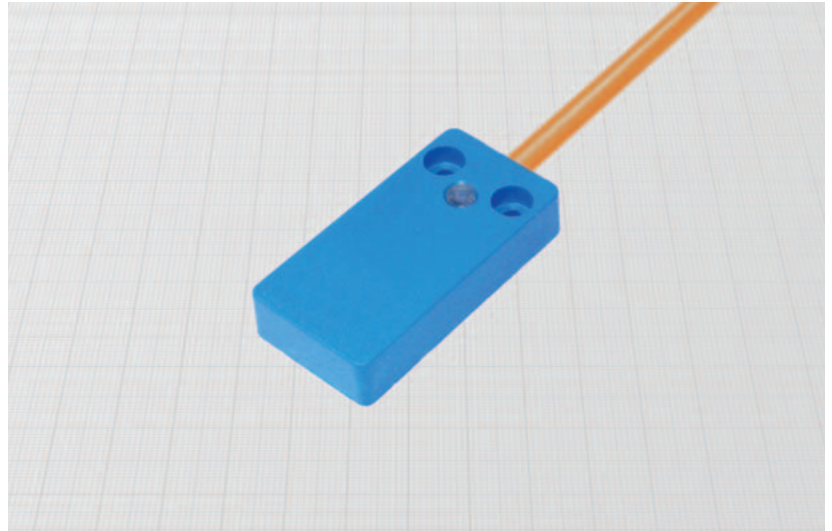
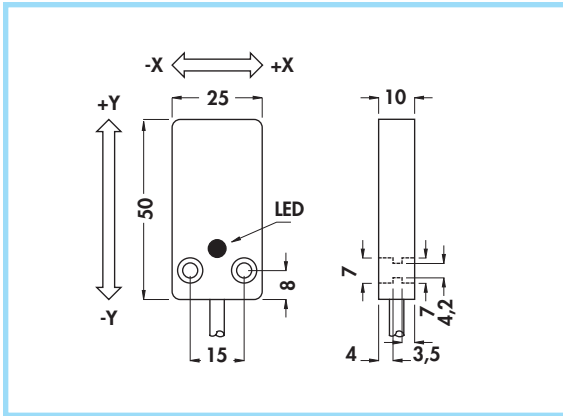

Materials:

- Cable: 2 m PVC CEI 20 - 22 II; 90°C
- Housing: plastic

General Features:

These sensors give two output signals from 0,7 to 4,3 V proportional to the inclination of the X and Y axis respect the earth axis. An inclination of 0° gives on the outputs + 2,5 V respect to the negative of power supply (blue wire) or 0 V respect to the OUT zero.

Other outputs such as temperature and ON/OFF alarms, which are factory preset at specified thresholds, are available upon request.

Applications:

- Inclination control on lifting systems
- Vehicles inclination monitoring
- Feedback sensor on self-levelling systems

Technical data:

- Measuring range: - 60° ÷ + 60°
- Resolution: 0,2°
- Supply voltage: 8 ÷ 30 Vdc
- Power consumption: ≤ 10 mA
- Output voltage range:
 - respect to - V: 0,7 ÷ 4,3 V
 - respect to Out zero: - 1,8 ÷ + 1,8 V
- Sensitivity: 0,03 V/°
- Max thermal drift: 4,5 m V/°C
- Output resistance: 100 Ω
- Response time: 0,1 sec
- Linearity: < 1% full scale
- Hysteresis: < 0,2% full scale
- Cross axis sensitivity: < ± 2%
- Maximum survival shock: 1000 g
- Working temperature: 0 ÷ 70° C
- Storage temperature: - 20° ÷ 100° C
- Degree of protection: IP67
- Cable conductor cross section: 0,22 mm² + shield
- LED indication: green = supply voltage
- Shock and vibration resistance according to EN60068-2-27 EN60068-2-6
- Electromagnetic compatibility (EMC) according to EN61000-6-2/-4

Type	Cable diameter	ORDERING REFERENCES
	mm	
Biaxial	5	ISX/2660S

3 AXES VIBRATION AND SHOCK SENSOR • 4 ÷ 20 mA Output • M12x1 connector output •

Housing B-12

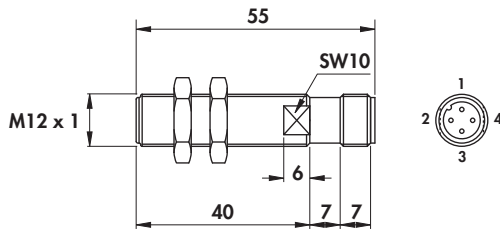

Direct wiring for RMS measurements

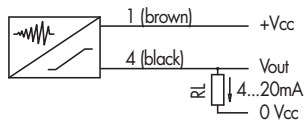

Reverse wiring for instantaneous value or peak detection

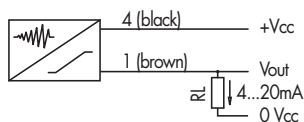

RL calculation:

- $RL \text{ (max)} = \frac{(V_{dc}-8)}{20} \text{ K}\Omega$

Materials:

- Housing: stainless steel



General features:

These new accelerometers give a single 4 ÷ 20 mA signal proportional to the vibrations applied to X, Y and Z axes. Since the measurement is made from a very low frequency, the acceleration due to gravity is not detected, so the measurement will not be affected by the mounting position.

Depending on the connection polarity (direct or reverse) it's possible to perform the RMS measurement on the vectorial sum of the acceleration on the three axes X, Y and Z or the instantaneous value, simply reversing the two connection wires.

On the version VBS... (bump sensor) the highest instantaneous value is held on the output for one second, allowing analogue value measurement.

For a reliable connection it is recommended to use M12x1 connectors with the shield of the cable connected to the nut (see section H of the catalogue).

Applications:

- Collision detection on electrospindles, handles and robot arms
- Unbalancing detection of tools on milling and grinding machines
- Detection of wearing or abnormal working of ball bearings and rotating parts
- Detection of incorrect loading of drum in washing machines
- Out of balance loads on rotating machinery

Technical data:

- Measuring range: $\pm 6 \text{ g}; \pm 10 \text{ g}$
- Supply voltage: $8 \div 40 \text{ Vdc}$
- Output current: $4 \div 20 \text{ mA}$
- Output current variation: see the table
- Hold time of the peak value (version VBS...): 1 sec.
- Frequency range: $2 \div 300 \text{ Hz}$
- Max survival shock: 2000 g
- Working temperature: $-20^\circ \div +80^\circ \text{ C}$
- Degree of ingress protection: IP68/IP69K
- Shock and vibration resistance according to EN60068-2-27 EN60068-2-6
- Electromagnetic compatibility (EMC) according to EN61000-6-2/-4



Axes	Output	Output current variation	Full scale measure	Female connector (see section H)	ORDERING REFERENCES
	Direct/reverse wiring	mA/g	g	n°	
3 (X, Y, Z)	RMS/instantaneous value	2,66	6	8B - 10	VS12X/3306
3 (X, Y, Z)	RMS/instantaneous value	1,60	10	8B - 10	VS12X/3310
3 (X, Y, Z)	RMS/peak value	2,66	6	8B - 10	VBS12X/3306
3 (X, Y, Z)	RMS/peak value	1,60	10	8B - 10	VBS12X/3310

ACCELERATION SENSORS

2 AXES INCLINATION SENSORS with analogue voltage output

- Self teaching of zero position
- High thermal stability
- Insensitive to shock and vibrations
- Low power

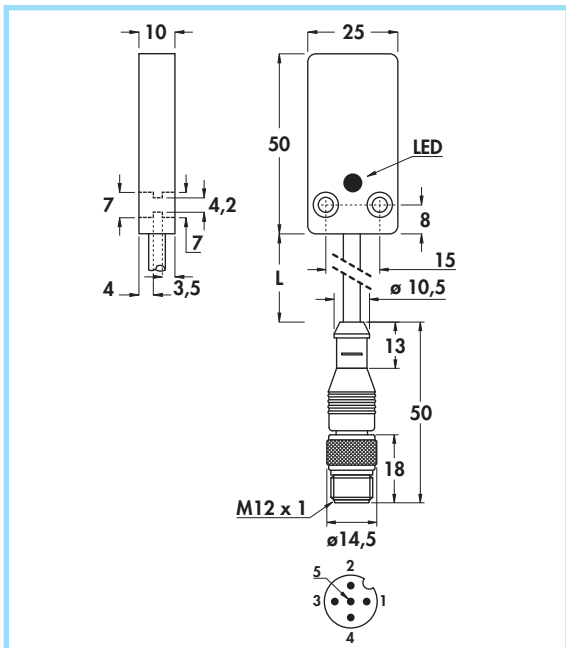

General features:

These sensors give two output voltage signals proportional to the inclination of the X and Y axes with respect to the earth axis. An inclination of 0° gives on the outputs 50% of the maximum value full scale with respect to the negative of the power supply. The sensor is insensitive to shocks and vibrations and the absolute zero position is factory calibrated to ground level. For a reliable connection it is recommended to use M12x1 connectors with the shield of the cable connected to the nut (see section H of the catalogue).

Self teaching of zero position:

Even though the sensor is factory calibrated, the input "zero-teach" allows the compensation of mounting tolerances up to ± 10°. Self compensation is achieved by connecting the input "zero teach" to the negative of the power supply for between 2 and 10 seconds. The compensation process is indicated by the yellow LED. When the compensation is complete (after about 1 second) the yellow and green LEDs will flash. At this stage the connection between the zero-teach and the negative must be removed.

Applications:

- Inclination control on lifting systems
- Vehicle inclination monitoring
- Feedback sensor on self-levelling systems

Technical data:

- No load supply current: ≤ 10 mA
- Max zero position error: ± 50 mV
- Max thermal drift: 4,5 mV/°C
- Max output current (source): 20 mA
- Response time: 0,1 sec
- Linearity: < 1% full scale
- Cross axis sensitivity: < ± 2%
- Maximum survival shock: 1000 g
- Working temperature: - 20 ÷ + 70°C
- Storage temperature: - 20 ÷ + 100°C
- Degree of ingress protection: IP67
- LED indications: Green = supply voltage, Yellow = zero-teach

- Shock and vibration resistance according to EN60068-2-27 EN60068-2-6
- Electromagnetic compatibility (EMC) according to EN61000-6-2/-4

Axes position

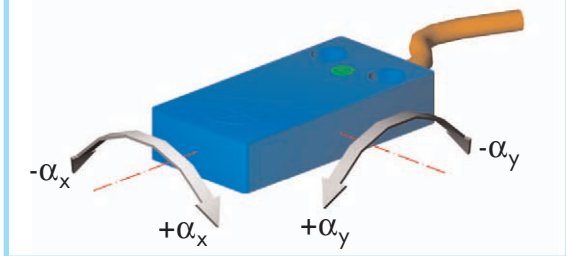

Typical curve

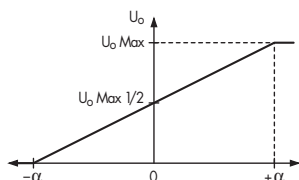

Connection diagram

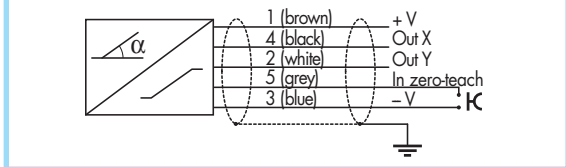

Materials:

- Cable: PVC CEI 20 - 22 II; 90° C
- Housing: plastic
- Connector locking nut: nickel plated brass

Axes	Measuring range α	Output (U_o)	Power supply (U_b)	Resolution	Sensitivity	Cable length (L)	Female connector (see section H)	ORDERING REFERENCES
	± °	V	V					
2	15	0 ÷ 5	8 ÷ 30	0,1	0,15	0,3	10	ISX/2H15AS-0,3
2	15	0 ÷ 10	15 ÷ 30	0,1	0,30	0,3	10	ISX/2H15BS-0,3
2	60	0 ÷ 5	8 ÷ 30	0,2	0,04	0,3	10	ISX/2H60AS-0,3
2	60	0 ÷ 10	15 ÷ 30	0,2	0,08	0,3	10	ISX/2H60BS-0,3

2 AXES INCLINATION SWITCH ($\pm 60^\circ$) with 2 on/off static outputs

- Insensitive to shock and vibrations
- Low power

- Self teaching of zero position and threshold
- High thermal stability

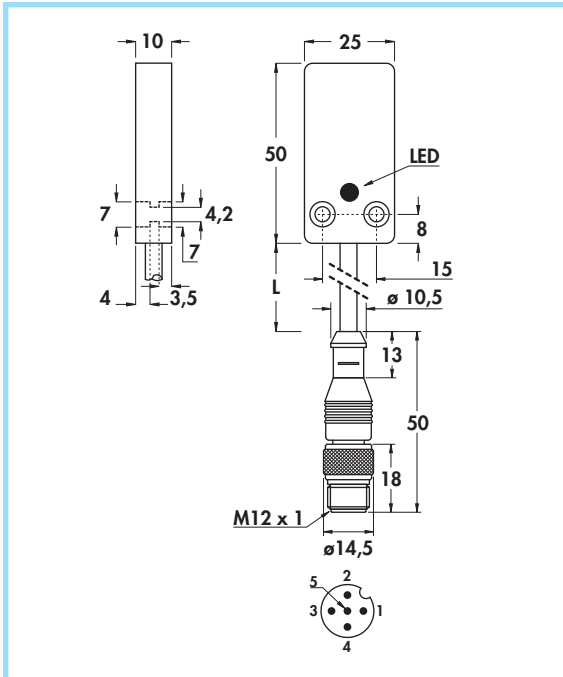

Axes position

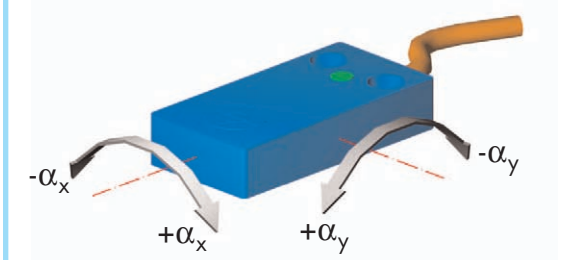

Connection diagram

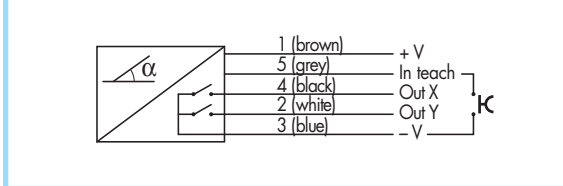

Materials:

- Cable: PVC CEI 20 - 22 II; 90° C
- Housing: plastic
- Connector locking nut: nickel plated brass

General features:

These sensors give two NPN normally open outputs which connect to the negative power supply when the preset thresholds of the X and Y axes are exceeded. The sensor is insensitive to shocks and vibrations and the absolute zero is factory calibrated to ground level. The thresholds can be factory preset at specified values. If not otherwise specified both the thresholds are preset at $\pm 5^\circ$ for both the axes. Both the thresholds and the zero position can be modified in the field.

Applications:

- Inclination control on lifting systems
- Vehicle inclination monitoring
- Feedback sensor on self-levelling systems

Technical data:

- Measuring range: $\pm 60^\circ$
- Resolution: $0,2^\circ$
- Supply voltage: $8 \div 40 V_{cc}$
- No load supply current: $\leq 10 \text{ mA}$
- Output: NPN n.o. open collector
- Max thermal drift of switching point: $0,03^\circ / ^\circ\text{C}$
- Max output current: 200 mA
- Max response time: 0,1 sec
- Cross axis sensitivity: $< \pm 2\%$
- Maximum survival shock: 1000 g
- Working temperature: $-20 \div +70^\circ\text{C}$
- Storage temperature: $-20 + 100^\circ\text{C}$
- Degree of ingress protection: IP67
- LED indications: Green = supply voltage
Yellow = threshold exceeding
- Shock and vibration resistance according to EN60068-2-27 EN60068-2-6
- Electromagnetic compatibility (EMC) according to EN61000-6-2/-4



Axes	Cable length (L)	Female connector (see section H)	ORDERING REFERENCES
	m	n°	
2	0,3	8B - 10	ISX/2H60DS-0,3

2 AXES INCLINATION SENSORS with analogue voltage output

- High thermal stability
- Low power
- Rugged anodized aluminum housing
- Insensitive to shock and vibrations

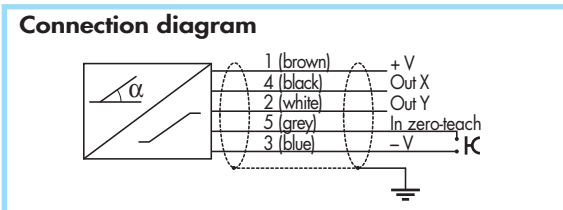
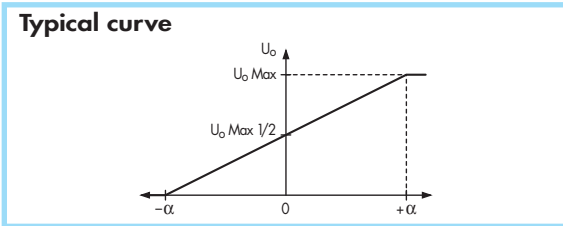
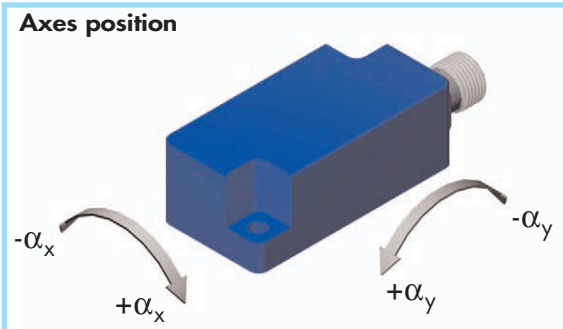
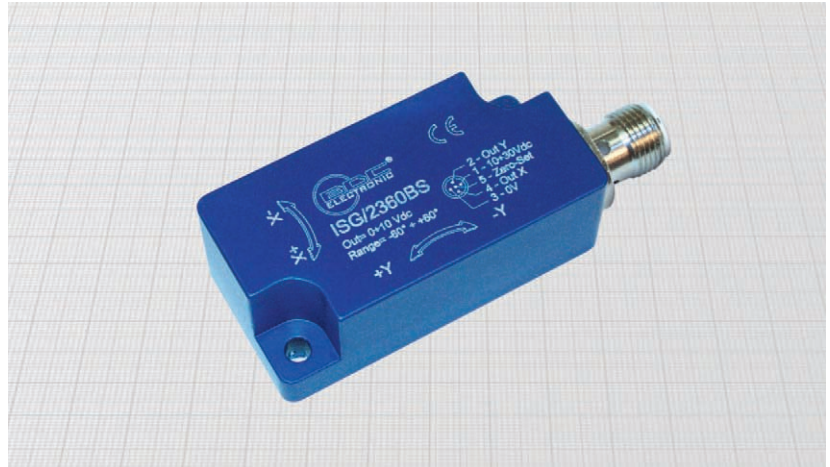
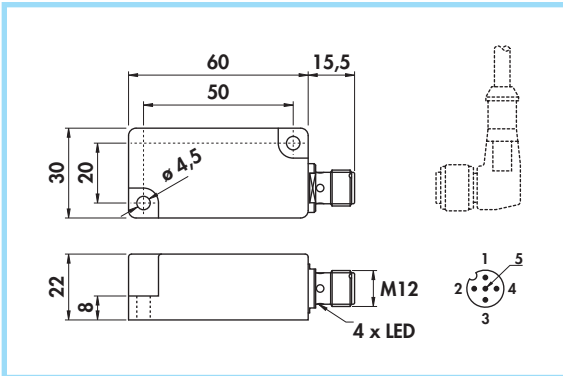

Materials:

- Housing: anodized aluminum
- Connector: nickel plated brass

General features:

These sensors give two output voltage signals proportional to the inclination of the X and Y axes with respect to the earth axis. An inclination of 0° gives on the outputs 50 % of the maximum value full scale with respect to the negative of the power supply. The anodized aluminum housing makes this sensor extremely robust, immune to UV rays and suitable for outdoor applications such as solar trackers and nautical installations. The sensor is insensitive to shocks and vibrations and the absolute zero position is factory calibrated to ground level. For a reliable connection it is recommended to use M12x1 connectors with the shield of the cable connected to the nut (see section H of the catalogue).

Self teaching of zero position:

Even though the sensor is factory calibrated, the input "zero-teach" allows the compensation of mounting tolerances up to ± 10°. Self compensation is achieved by connecting the input "zero teach" to the negative of the power supply for between 2 and 10 seconds. The compensation process is indicated by the yellow LED. When the compensation is complete (after about 1 second) the yellow and green LEDs will flash. At this stage the connection between the zero-teach and the negative must be removed.

Applications:

- Solar trackers
- Inclination control on lifting systems
- Vehicle inclination monitoring
- Feedback sensor on self-levelling systems

Technical data:

- No load supply current: ≤ 10 mA
- Max zero position error: ± 50 mV
- Max thermal drift: 4,5 mV/°C
- Max output current (source): 20 mA
- Response time: 0,1 sec
- Linearity: < 1% full scale
- Cross axis sensitivity: < ± 2%
- Maximum survival shock: 1000 g
- Working temperature: - 40 ÷ + 85° C
- Storage temperature: - 40 ÷ + 100° C
- Degree of ingress protection: IP68/IP69K
- LED indications: Green = supply voltage
Yellow = zero-teach
- Shock and vibration resistance according to EN60068-2-27 EN60068-2-6
- Electromagnetic compatibility (EMC) according to EN61000-6-2/-4

Axes	Measuring range α	Output (U_o)	Power supply (U_b)	Resolution	Sensitivity	Female connector (see section H)	ORDERING REFERENCES
	± °	V	V	°	V/°	n°	
2	15	0 ÷ 5	8 ÷ 30	0,05	0,15	10	ISG/2315AS
2	15	0 ÷ 10	15 ÷ 30	0,05	0,30	10	ISG/2315BS
2	60	0 ÷ 5	8 ÷ 30	0,1	0,04	10	ISG/2360AS
2	60	0 ÷ 10	15 ÷ 30	0,1	0,08	10	ISG/2360BS

2 AXES INCLINATION SWITCH ($\pm 60^\circ$) with 2 on/off static outputs

- High thermal stability •
- Low power •

- Rugged anodized aluminum housing •
- Insensitive to shock and vibrations •

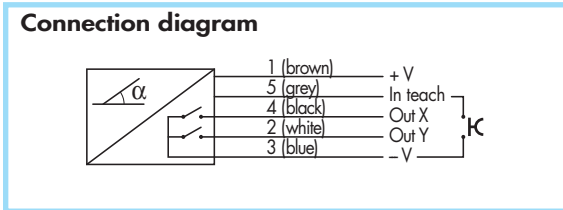
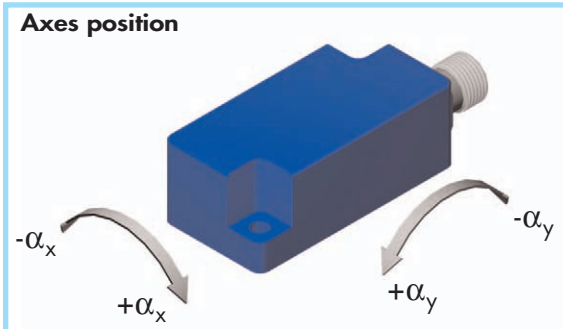
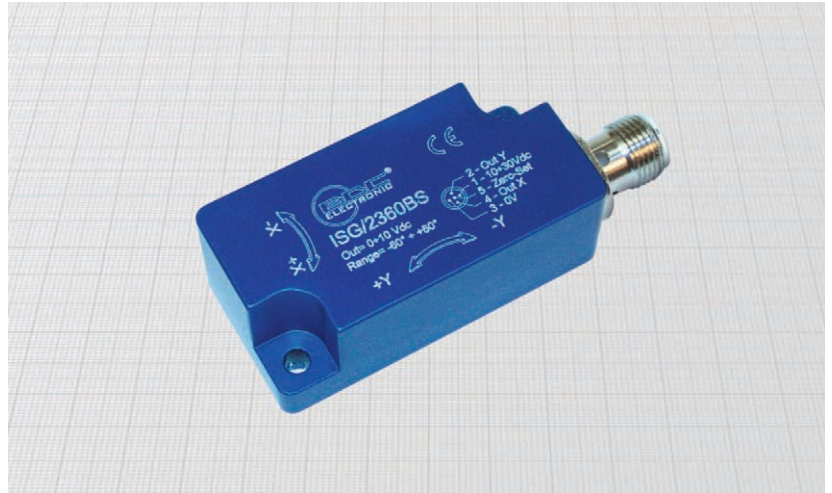
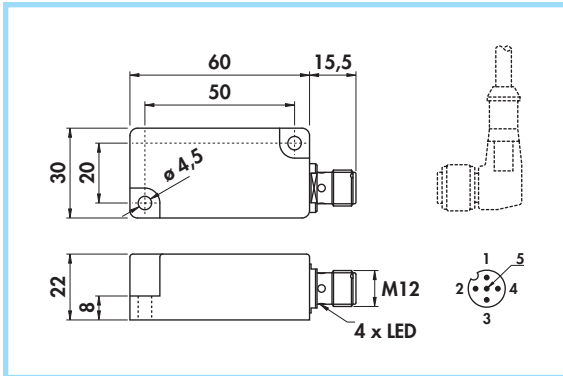

Materials:

- Housing: anodized aluminum
- Connector: nickel plated brass

General features:

These sensors give two NPN normally open outputs which connect to the negative power supply when the preset thresholds of the X and Y axes are exceeded. The anodized aluminum housing makes this sensor extremely robust, immune to UV rays and suitable for outdoor applications such as solar trackers and nautical installations. The sensor is insensitive to shocks and vibrations and the absolute zero is factory calibrated to ground level.

The thresholds can be factory preset at specified values. If not otherwise specified both the thresholds are preset at $\pm 5^\circ$ for both the axes. Both the thresholds and the zero position can be modified in the field.

Applications:

- Solar trackers
- Inclination control on lifting systems
- Vehicle inclination monitoring
- Feedback sensor on self-levelling systems

Technical data:

- Measuring range: $\pm 60^\circ$
- Resolution: $0,1^\circ$
- Supply voltage: $8 \div 40 V_{cc}$
- No load supply current: $\leq 10 \text{ mA}$
- Output: NPN n.o. open collector
- Max thermal drift of switching point: $0,02^\circ / ^\circ C$
- Max output current: 200 mA
- Max response time: 0,1 sec
- Cross axis sensitivity: $< \pm 2\%$
- Maximum survival shock: 1000 g
- Working temperature: $-40 \div +85^\circ C$
- Storage temperature: $-40 \div +100^\circ C$
- Degree of ingress protection: IP68/IP69K
- LED indications: Green = supply voltage, Yellow = threshold exceeding
- Shock and vibration resistance according to EN60068-2-27 EN60068-2-6
- Electromagnetic compatibility (EMC) according to EN61000-6-2/-4



Axes	Female connector (see section H)	ORDERING REFERENCES
	n°	
2	8B - 10	ISG/2360DS

AMPLIFIERS FOR SENSORS

OP = optocoupled static output
TOP = timed optocoupled static output
RL = relay output
TRL = timed relay output

24 = supply voltage 24 Vdc or Vac
1122 = supply voltage 85 ± 260 Vac

AM	OP	24	/	2
-----------	-----------	-----------	----------	----------

n° channels

OPTOCOUPLED STATIC OUTPUTS •

1 or 2 channels •

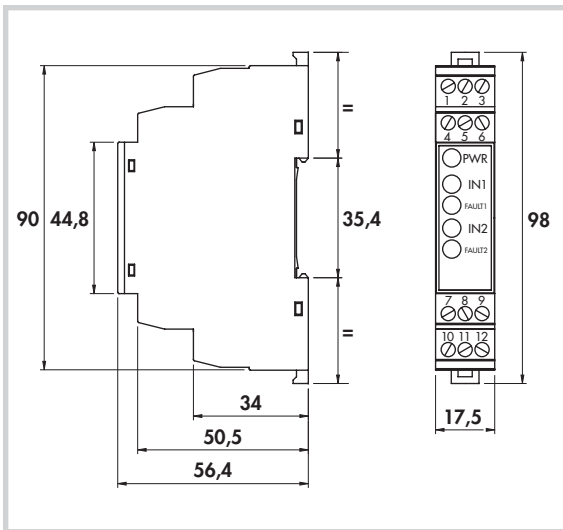

Connections AM-OP-24/2

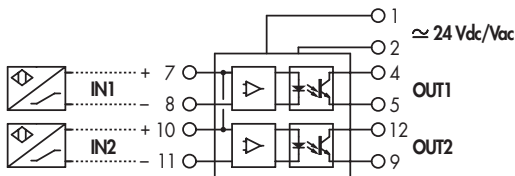

Connections AM-OP-1122/1

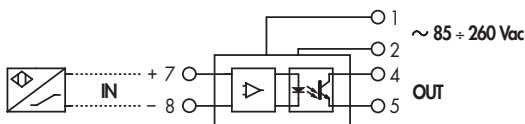

Dip-Switches settings

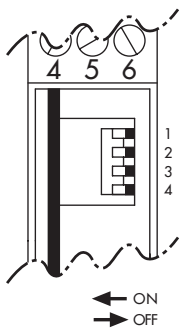

DIP	POSITION	CONFIGURATION
1	OFF	OUT1 N.O.
	ON	OUT1 N.C.
2	OFF	IN1 Failure detection disabled
	ON	IN1 Failure detection enabled
3	OFF	OUT2 N.O.
	ON	OUT2 N.C.
4	OFF	IN2 Failure detection disabled
	ON	IN2 Failure detection enabled

General Features:

These units allow to amplify signals from NAMUR sensors or contacts. Each output is electrically insulated from each other, from power supply and from all the inputs. It is possible to configure them as N.O. or N.C. and use them as PNP or NPN. They are protected against over voltages on lines, overload and short circuit. When used for NAMUR sensors, the indication of failures is visible with a red LED on the front panel for interruptions or short circuits on the input lines. The configuration dip-switches are easily accessible removing the front panel. Suitable for DIN rail mounting.

Technical data:

- Supply voltage: see ordering references
- Frequency of power supply: DC or 50 - 60 Hz
- Power consumption max: see ordering references
- Working temperature: -25 ÷ +60°C
- Storage temperature: -40 ÷ +80°C
- According to EN60947-5-6
- Electromagnetic compatibility (EMC) according to EN61000-6-2/-4 **CE**
- Degree of protection: IP20

INPUT PARAMETERS

- Switching point to ON: 1,55 ÷ 1,75 mA
- Switching point hysteresis: 0,2 mA
- Failure detection thresholds: open circuit detection when I < 0,05 mA
short circuit detection when I > 7,45 mA (Ri < 100Ω)

OUTPUTS

- Output function: N.O. or N.C. as for DIP-SW settings
- Polarity: NPN/PNP
- Switching frequency max: 900 Hz
- Input/output delay max: 700 μs
- Output current max: 300 mA
- Max applicable voltage through the load: 65 V
- Voltage drop max in ON condition: 1,7 V
- Insulation from power supply and from inputs: 2500 V

SUPPLY VOLTAGE	N. CHANNELS	POWER CONSUMPTION MAX mA	ORDERING REFERENCES
24 V a.c. - d.c. ± 20%	2	60	AM-OP-24/2
85 ÷ 260 Va.c.	1	20	AM-OP-1122/1

AMPLIFIERS FOR SENSORS

• OPTOCOUPLED STATIC OUTPUT

• 1 Timed channel

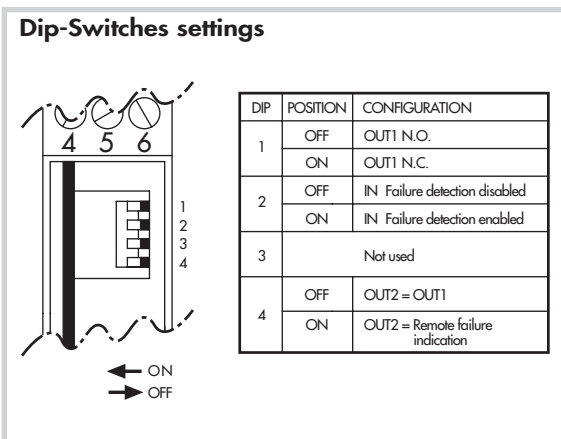
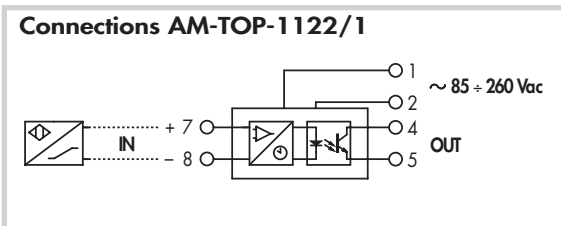
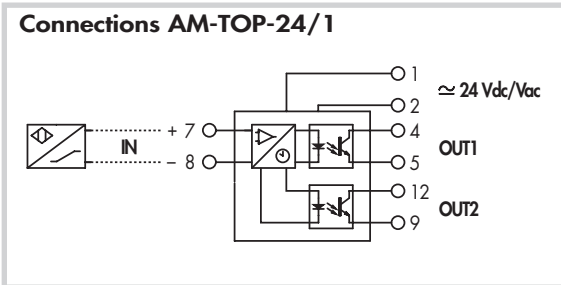
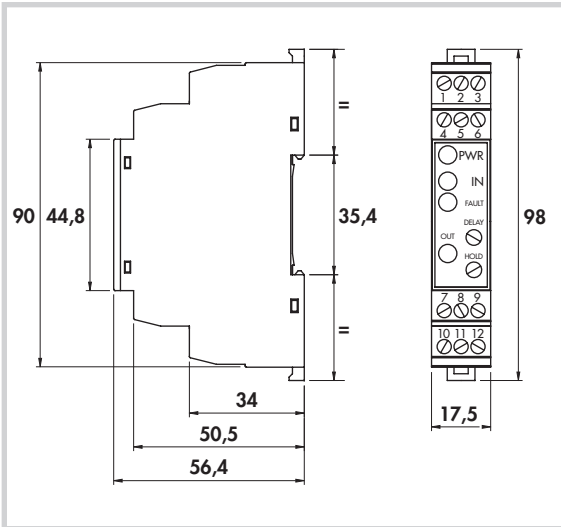

General Features:

These units allow to amplify signals from NAMUR sensors or contacts. The delay time and hold time respect the input signal are adjustable through potentiometers on the front panel. Each output is electrically insulated from each other, from power supply and from all the inputs. It is possible to configure them as N.O. or N.C. and use them as PNP or NPN. They are protected against over voltages on lines, overload and short circuit. On the 24V version is also possible to configure the OUT2 with the same function of OUT1 or use it as remote failure indication. When used for NAMUR sensors, the indication of failures is visible with a red LED on the front panel for interruptions or short circuits on the input lines. The configuration dip-switches are easily accessible removing the front panel. Suitable for DIN rail mounting.

Technical data:

- Supply voltage: see ordering references DC or 50 - 60 Hz
- Frequency of power supply: see ordering reference
- Power consumption max: - 25 ÷ + 60° C
- Working temperature: - 40 ÷ + 80° C
- Storage temperature: IP20
- Degree of protection:
- According to EN60947-5-6
- Electromagnetic compatibility (EMC) according to EN61000-6-2/-4

INPUT PARAMETERS

- Switching point to ON: $\geq 1,75$ mA
- Switching point hysteresis: 0,2 mA
- Failure detection thresholds: open circuit detection when $I < 0,05$ mA
short circuit detection when $I > 7,45$ mA ($R_i < 100$ ohm)

OUTPUTS

- Output function: N.O. or N.C. as for DIP-SW settings
- Polarity: NPN/PNP
- Switching frequency max: 900Hz
- Input/output delay max: 700µs
- Output current max: 300 mA
- Max applicable voltage through the load: 65 V
- Voltage drop max in ON condition: 1,7 V
- Insulation from power supply and from inputs: 2500 V
- Range of delay and hold timing adjustment: 700 µsec ÷ 25,6 sec

SUPPLY VOLTAGE	N. CHANNELS	POWER CONSUMPTION MAX mA	ORDERING REFERENCES
24 V a.c. - d.c. ± 20%	1	60	AM-TOP-24/1
85 ÷ 260 Va.c.	1	20	AM-TOP-1122/1

RELAY OUTPUT •

1 or 2 channels •

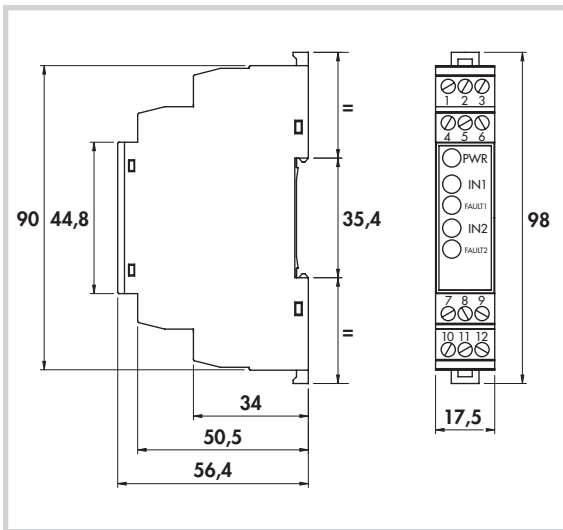

Connections AM-RL-24/2

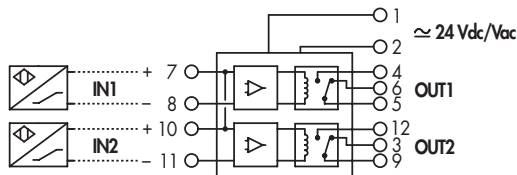

Connections AM-RL-1122/1

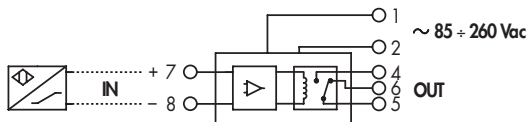

Dip-Switches settings

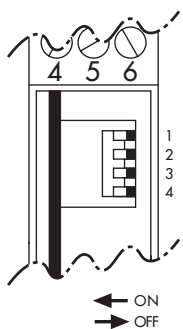

DIP	POSITION	CONFIGURATION
1	OFF	OUT1 N.O.
	ON	OUT1 N.C.
2	OFF	IN1 Failure detection disabled
	ON	IN1 Failure detection enabled
3	OFF	OUT2 N.O.
	ON	OUT2 N.C.
4	OFF	IN2 Failure detection disabled
	ON	IN2 Failure detection enabled

General Features:

These units allow to amplify signals from NAMUR sensors or contacts. The relay outputs have changeover N.O. + N.C. contacts electrically insulated from each other, from power supply and from all the inputs. When used for NAMUR sensors, the indication of failures is visible with a red LED on the front panel for interruptions or short circuits on the input lines. The configuration dip-switches are easily accessible removing the front panel. Suitable for DIN rail mounting.

Technical data:

- Supply voltage: see ordering references
- Frequency of power supply: DC or 50 - 60 Hz
- Power consumption max: see ordering references
- Working temperature: - 25 ÷ + 60°C
- Storage temperature: - 40 ÷ + 80°C
- Degree of protection: IP20
- According to EN60947-5-6
- Electromagnetic compatibility (EMC) according to EN61000-6-2/-4

INPUT PARAMETERS

- Switching point to ON: $\geq 1,75$ mA
- Switching point hysteresis: 0,2 mA
- Failure detection thresholds: open circuit detection when $I < 0,05$ mA
- short circuit detection when $I > 7,45$ mA ($R_i < 100$ ohm)

OUTPUTS

- Output function: NO + NC (SPDT)
- Maximum contact voltage: 250 V
- Rated current: 5 A
- Activation/release typical time: 5/2 msec
- Bouncing on N.O./N.C. contacts typical: 1/5 msec
- Insulation from power supply and from inputs: 2500 V

SUPPLY VOLTAGE	N. CHANNELS	POWER CONSUMPTION MAX mA	ORDERING REFERENCES
24 V a.c. - d.c. $\pm 20\%$	2	60	AM-RL-24/2
85 ÷ 260 V a.c.	1	20	AM-RL-1122/1

AMPLIFIERS FOR SENSORS

• RELAY OUTPUT

• 1 Timed channel

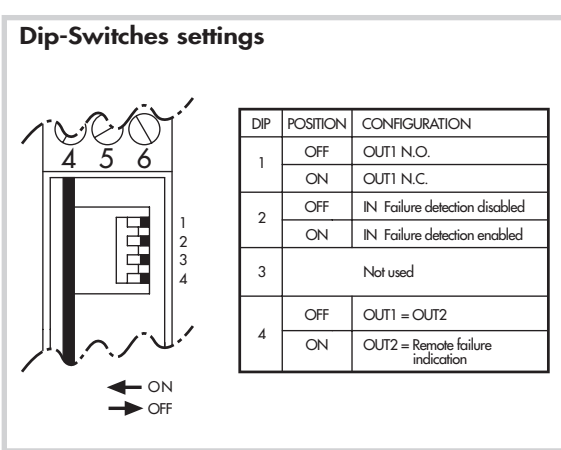
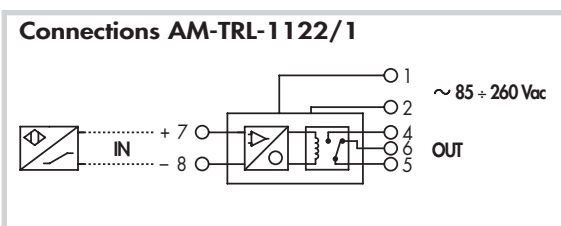
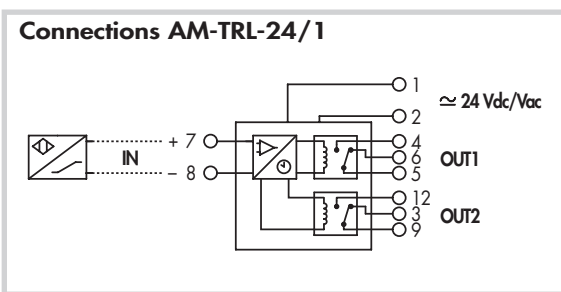
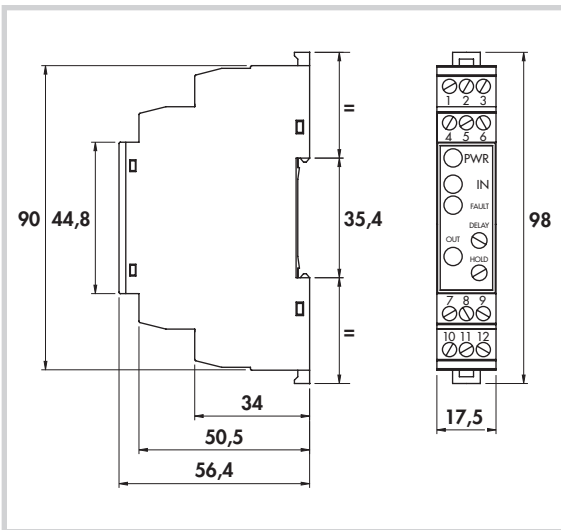

General Features:

These units allow to amplify signals from NAMUR sensors or contacts. The delay time and hold time respect the input signal are adjustable through potentiometers on the front panel. The relay outputs have changeover N.O.+N.C. contacts electrically insulated from each other, from power supply and from all the inputs. On the 24V version is also possible to configure the OUT2 with the same function of OUT1 or use it as remote failure indication. When used for NAMUR sensors, the indication of failures is visible with a red LED on the front panel for interruptions or short circuits on the input lines. The configuration dip-switches are easily accessible removing the front panel. Suitable for DIN rail mounting.

Technical data:

- Supply voltage: see ordering references
- Frequency of supply voltage: DC or 50 - 60 Hz
- Power consumption max: see ordering references
- Working temperature: -25° ÷ +60° C
- Storage temperature: -40° ÷ +80° C
- Degree of protection: IP20
- According to EN60947-5-6
- Electromagnetic compatibility (EMC) according to EN61000-6-2/-4

INPUT PARAMETERS

- Switching point to ON: ≥ 1,75 mA
- Switching point hysteresis: 0,2 mA
- Failure detection thresholds: open circuit detection when I < 0,05mA
short circuit detection when I > 7,45 mA (Ri < 100ohm)

OUTPUTS

- Output function: NO + NC (SPDT)
- Maximum contact voltage: 250 V
- Rated current: 5A
- Bouncing on N.O./N.C. contacts typical: 1/5 msec
- Insulation from power supply and from inputs: 2500 V
- Range of delay and hold timing adjustments: 10 msec. ÷ 25,6 sec.

SUPPLY VOLTAGE	N. CHANNELS	POWER CONSUMPTION MAX mA	ORDERING REFERENCES
24 V a.c. - d.c. ± 20%	1	60	AM-TRL-24/1
85 ÷ 260 V a.c.	1	20	AM-TRL-1122/1

General Features:

This section presents sensors already cabled to male connectors for particular applications. Specific cable lengths are available upon request on all the products. BDC versions with rotating nut allow the direct connection to the connection boxes getting down the costs and improving the reliability of the plant. Other solutions with different products are possible according to the customer specification. The suggested connectors have to be matched to the sensors according to the cable sections, indicated on the ordering references tables inside the catalogue.

HOW TO COMPOSE THE ORDERING REFERENCES

Type



Cable length (m)

Type	Dimensions	Manufacturer	Series	Degree of protection	Suitable for cables diameter (mm)
F		BDC	M8 x 1 fixed nut	IP67	3 - 3,5 - 4 - 5
R		BDC	M8 x 1 rotating nut	IP67	3 - 3,5 - 4 - 5
H		BDC	M12 x 1 rotating nut	IP68	4 - 5
M		Tyco-AMP	Superscal	IP67	4 - 5 - 6
D		Deutsch	DTM	IP67	4 - 5 - 6
DT		Deutsch	DT	IP67	5 - 6

Note: more detailed technical data are available on specific manufacturers data sheets.

HOW TO INTERPRETE THE ORDERING REFERENCES

N° Connector:	8B	= angled female M12 x 1 for d.c. sensors
	8M	= straight male M8 x 1 for d.c. sensors
	9	= straight male M12 x 1 for d.c. sensors
	9B	= angled male M12 x 1 for d.c. sensors
	10	= straight female M12 x 1 for d.c. sensors
	11	= straight female M8 x 1 for d.c. sensors
	12	= angled female M8 x 1 for d.c. sensors
	15	= straight female M12 x 1 single key for a.c. sensors
	16	= angled female M12 x 1 single key for a.c. sensors
	17	= straight female M12 x 1 double key for a.c. sensors
18	= angled female M12 x 1 double key for a.c. sensors	

0	= without LED
2	= with 2 LED

C	10	/	2	P	3	2	PV	A
----------	-----------	----------	----------	----------	----------	----------	-----------	----------

0	= without LED
P	= PNP with LED
N	= NPN with LED

N° conductors:	3	= 3 wires
	4	= 4 wires
	5	= 5 wires

Cable length m.	2	= 2 m.
	5	= 5 m.
	10	= 10 m.

Cable material:	PV	= PVC (orange)
	PR	= PUR (orange)
	VS	= PVC shielded
	T	= Thermoplastic rubber (-40° ÷ + 140° C)

Atex Versions:	A	= 1G - 1D Category
	3GD	= 3G - 3D Category

Note:

Using female connectors, please consider an insertion length inside the sensor, which is :

M12 connectors	= 8 mm
M8 connectors	= 4 mm

I.e. Sensor DSA8/4909KS total length = 35 mm
 Connector C12/0032PV total length = 17,5 mm
 Overall dimension sensor + connector = (35 + 17,5) - 4 = 48,5 mm.

- Straight in d.c.
- Moulded with cable
- According to EN 60947-5-2

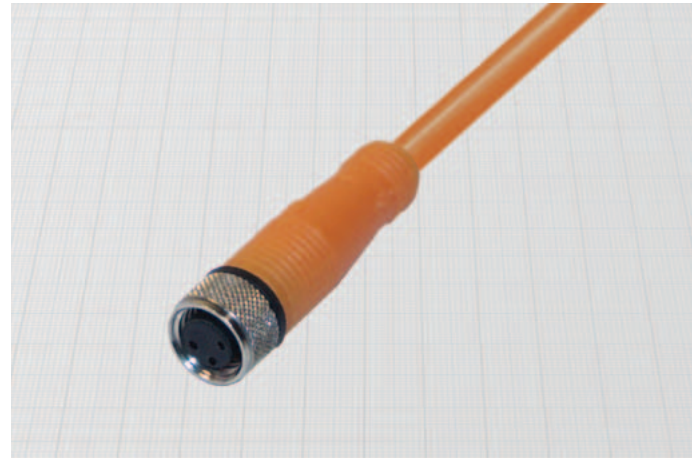
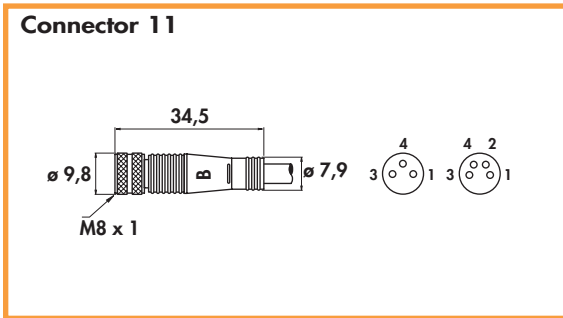

General Features:

Female connectors of this section can be matched to the proximity sensors as indicated on the ordering references tables of the products. They must be separately ordered.

These models offer a high degree of protection even in small dimensions. They are infact suitable for the smaller models of d.c. sensors. The self securing locking nut assures the resistance to vibrations.

Grey moulding and cable are available upon request.

Technical data:

- Operating voltage: 10 ÷ 30 Vdc types with LED
max 50 Vac/75 Vdc types without LED
- Maximum current: 4 A
- Contact resistance: ≤ 5 mΩ
- Contacts: CuZn, brass pre-nickel and gold plated (0,8 μm)
- Moulding: PUR
- Locking nut: self-locking in CuZn, nickel plated brass
- O-Ring: NBR
- Temperature range: -25° ÷ +90°C
- Degree of protection: IP68 with plug in fully locked position

			ORDERING REFERENCES				
			3 wires	3 wires with LED	4 wires	3 wires + shield	
Connector n°	Cable						
	Section	3 x 0,35 mm ² - ø ext. 4	3 x 0,35 mm ² - ø ext. 4	4 x 0,25 mm ² - ø ext. 4	3 x 0,22 mm ² + sch. - ø ext. 4		
	Material						
	Length m.						
		1) brown + 4) black output 3) blue -	PNP 1) brown + 4) black output LED yellow LED green 3) blue -	NPN 1) brown + LED yellow LED green 4) black output 3) blue -	1) brown + 4) black output 2) white output NC 3) blue - 2) shield		
11	PVC	2	C11/0032PV	C11/2P32PV	C11/2N32PV	C11/0042PV	C11/0042VS
11	PVC	5	C11/0035PV	C11/2P35PV	C11/2N35PV	C11/0045PV	C11/0045VS
11	PVC	10	C11/00310PV	C11/2P310PV	C11/2N310PV	C11/00410PV	C11/00410VS
11	PUR	2	C11/0032PR	C11/2P32PR	C11/2N32PR	C11/0042PR	-
11	PUR	5	C11/0035PR	C11/2P35PR	C11/2N35PR	C11/0045PR	-
11	PUR	10	C11/00310PR	C11/2P310PR	C11/2N310PR	C11/00410PR	-

FEMALE CONNECTORS M8 x 1

- Angled in d.c.
- Moulded with cable
- According to EN 60947-5-2

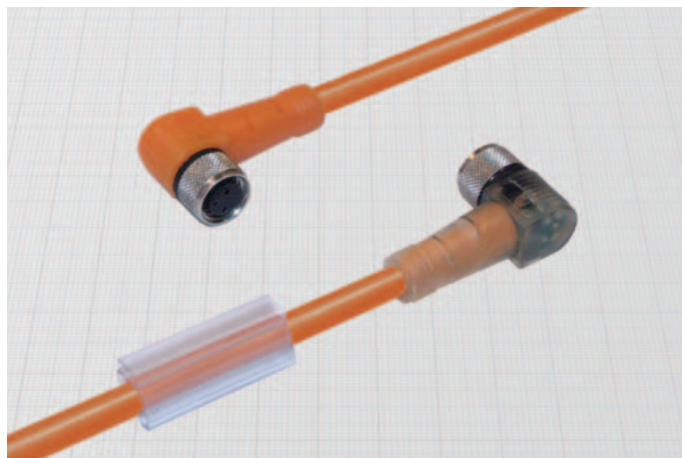
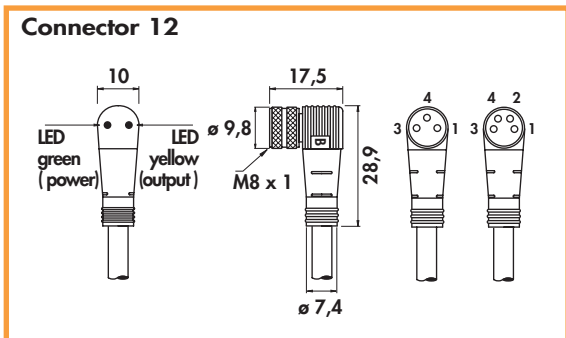

General Features:

Female connectors of this section can be matched to the proximity sensors as indicated on the ordering references tables of the products. They must be separately ordered.

These models offer a high degree of protection even in small dimensions. They are in fact suitable for the smaller models of d.c. sensors. The self securing locking nut assures the resistance to vibrations.

Grey moulding and cable are available upon request.

Technical data:

- Operating voltage: 10 ÷ 30 Vdc types with LED
max 50 Vac/75 Vdc types without LED
- Maximum current: 4 A
- Contact resistance: $\leq 5 \text{ m}\Omega$
- Contacts: CuZn, brass pre-nickel and gold plated (0,8 μm)
- Moulding: PUR
- Locking nut: selflocking in CuZn, nickel plated brass
- O-Ring: NBR
- Temperature range: $-25^\circ \div +90^\circ\text{C}$
- Degree of protection: IP68 with plug in fully locked position

Connector n°	Cable	ORDERING REFERENCES						
		3 wires	3 wires with LED	4 wires	3 wires + shield			
		Section	3 x 0,35 mm ² - \varnothing ext. 4		4 x 0,25 mm ² - \varnothing ext. 4	3 x 0,22 mm ² + sch. - \varnothing ext. 4		
Material	Length m.		PNP brown + black output LED yellow LED green LED blue -	NPN brown + LED yellow LED green black output blue -				
			1) brown + 4) black output 3) blue -		1) brown + 4) black output NO 2) white output NC 3) blue -		1) brown + 4) black output 3) blue - 2) shield	
12	PVC	2	C12/0032PV	C12/2P32PV	C12/2N32PV	C12/0042PV	C12/0042VS	
12	PVC	5	C12/0035PV	C12/2P35PV	C12/2N35PV	C12/0045PV	C12/0045VS	
12	PVC	10	C12/00310PV	C12/2P310PV	C12/2N310PV	C12/00410PV	C12/00410VS	
12	PUR	2	C12/0032PR	C12/2P32PR	C12/2N32PR	C12/0042PR	-	
12	PUR	5	C12/0035PR	C12/2P35PR	C12/2N35PR	C12/0045PR	-	
12	PUR	10	C12/00310PR	C12/2P310PR	C12/2N310PR	C12/00410PR	-	

Straight in d.c. •
Moulded with cable •
 According to EN 60947-5-2 •

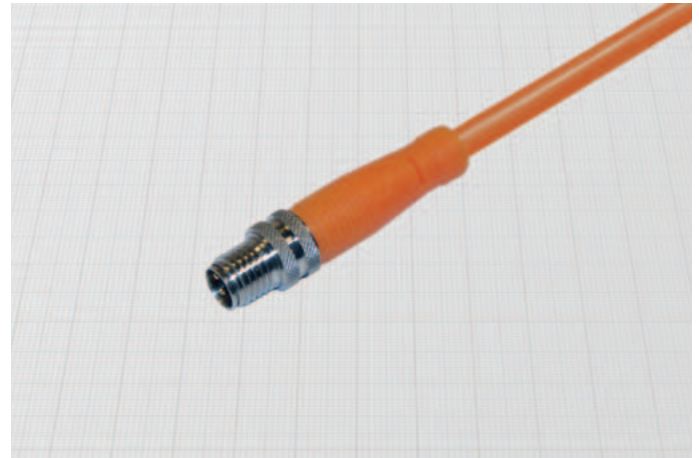
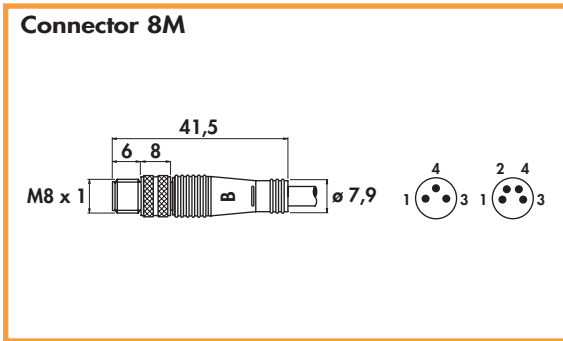

Technical data:

- Operating voltage: max 50 Vac/75 Vdc
- Maximum current: 4 A
- Contact resistance: $\leq 5 \text{ m}\Omega$
- Contacts: CuZn, brass pre-nickeled and gold plated (0,8 μm)
- Moulding: orange PUR
- Locking nut: CuZn, nickel plated brass
- Temperature range: $-25^\circ \div +90^\circ\text{C}$
- Degree of protection: IP67 with plug in fully locked position

Connector n°	Cable		ORDERING REFERENCES		
			3 wires	4 wires	3 wires + shield
	Section		3 x 0,35 mm ² - \emptyset ext. 4	4 x 0,25 mm ² - \emptyset ext. 4	3 x 0,22 mm ² + shield - \emptyset ext. 4
	Material	Length m.	1) brown + 4) black output 3) blue -	1) brown + 4) black output NO 2) white output NC 3) blue -	1) brown + 4) black output 3) blue - 2) shield
8M	PVC	2	C8M/0032PV	C8M/0042PV	C8M/0042VS
8M	PVC	5	C8M/0035PV	C8M/0045PV	C8M/0045VS
8M	PVC	10	C8M/00310PV	C8M/00410PV	C8M/00410VS
8M	PUR	2	C8M/0032PR	C8M/0042PR	-
8M	PUR	5	C8M/0035PR	C8M/0045PR	-
8M	PUR	10	C8M/00310PR	C8M/00410PR	-

FEMALE CONNECTORS M12 x 1

- **STRAIGHT** in d.c.
- **Moulded with cable**
- According to EN 60947-5-2

Connector 10

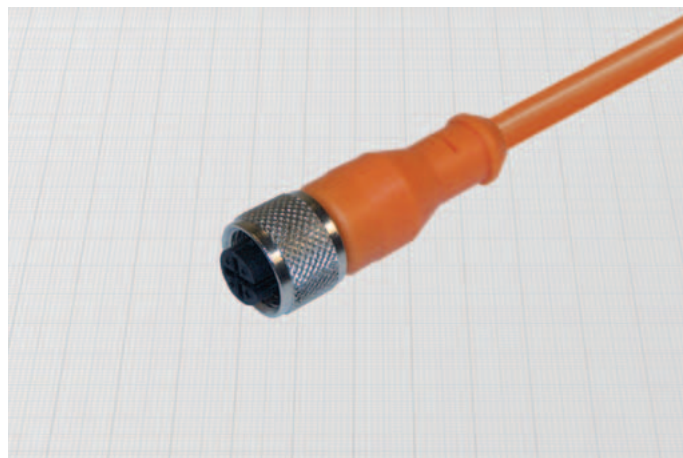
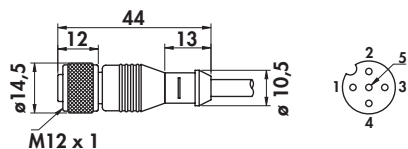

General Features:

Female connectors of this section can be matched to the proximity sensors as indicated on the ordering references tables of the products. They must be separately ordered. Particular moulding processes assure the maximum sealing, making these products suitable even for heavy applications. The self securing locking nut assures the resistance to vibrations. The two wires version can be used with all the two wires d.c. sensors either in N.O. or N.C. versions.

The shielded version offers a complete 360° shielding connected to the external nut. Grey moulding and cable are available upon request.

Technical data:

- Operating voltage: max 50 Vac/75 Vdc
- Maximum current: 4 A
- Contact resistance: $\leq 5 \text{ m}\Omega$
- Contacts: CuZn, brass pre-nickel and gold plated (0,8 μm)
- Moulding: orange PUR
- Locking nut: self-locking in CuZn, nickel plated brass
- O-Ring: NBR
- Temperature range: $-25^\circ \div +90^\circ\text{C}$
- Degree of protection: IP68 with plug in fully locked position

Connector n°	ORDERING REFERENCES					
	Cable		2 wires	3 wires	4 wires	5 wires + shield
	Section		2 x 0,75 mm ² - \varnothing ext. 5 (blu)	3 x 0,50 mm ² - \varnothing ext. 5	4 x 0,35 mm ² - \varnothing ext. 5	5 x 0,22 mm ² - \varnothing ext. 5
	Material	Length m.				
10	PVC	2	C10/0022PV	C10/0032PV	C10/0042PV	C10/0052VS
10	PVC	5	C10/0025PV	C10/0035PV	C10/0045PV	C10/0055VS
10	PVC	10	C10/00210PV	C10/00310PV	C10/00410PV	C10/00510VS
10	PUR	2	C10/0022PR	C10/0032PR	C10/0042PR	-
10	PUR	5	C10/0025PR	C10/0035PR	C10/0045PR	-
10	PUR	10	C10/00210PR	C10/00310PR	C10/00410PR	-

Straight in d.c. with LED •
Moulded with cable •
 According to EN 60947-5-2 •

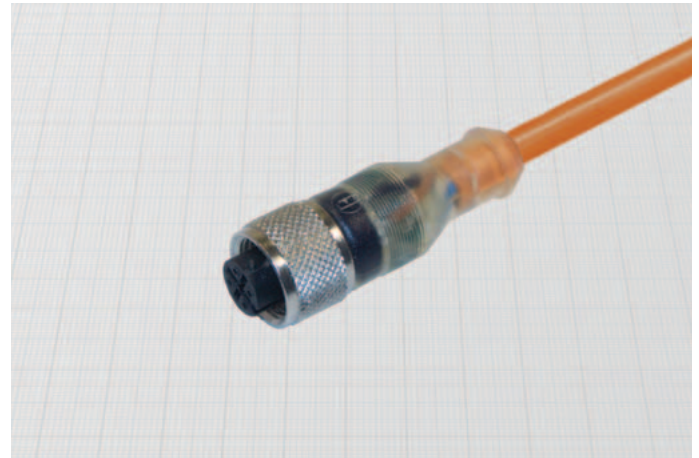
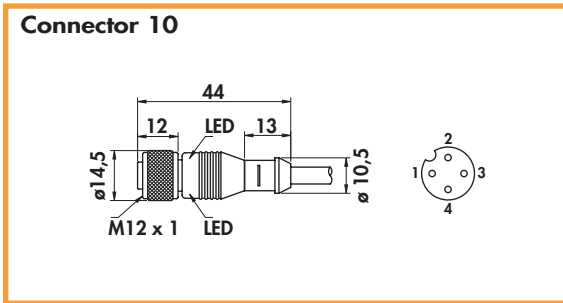

General Features:

Female connectors of this section can be matched to the proximity sensors as indicated on the ordering references tables of the products. They must be separately ordered.

Particular moulding processes assure the maximum sealing, making these products suitable even for heavy applications. The self securing locking nut assures the resistance to vibrations.

Grey moulding and cable are available upon request.

Technical data:

- Operating voltage: 10 ÷ 30 Vdc
- Maximum current: 4 A
- Contact resistance: ≤ 5 mΩ
- Contacts: CuZn, brass pre-nickel and gold plated (0,8 μm)
- Moulding: transparent PUR
- Locking nut: self-locking in CuZn, nickel plated brass
- O-Ring: NBR
- Temperature range: - 25° ÷ + 90°C
- Degree of protection: IP68 with plug in fully locked position

Connector n°	Cable	ORDERING REFERENCES				
		3 wires with LED		4 wires with LED		
		3 x 0,50 mm ² - ø ext. 5		4 x 0,35 mm ² - ø ext. 5		
Material	Length m.	PNP	NPN	PNP	NPN	
10	PVC	2				
10	PVC	5	C10/2P32PV	C10/2N32PV	C10/2P42PV	C10/2N42PV
10	PVC	10	C10/2P35PV	C10/2N35PV	C10/2P45PV	C10/2N45PV
10	PVC	10	C10/2P310PV	C10/2N310PV	C10/2P410PV	C10/2N410PV
10	PUR	2	C10/2P32PR	C10/2N32PR	C10/2P42PR	C10/2N42PR
10	PUR	5	C10/2P35PR	C10/2N35PR	C10/2P45PR	C10/2N45PR
10	PUR	10	C10/2P310PR	C10/2N310PR	C10/2P410PR	C10/2N410PR

FEMALE CONNECTORS M12 x 1

- Angled in d.c.
- Moulded with cable
- According to EN 60947-5-2

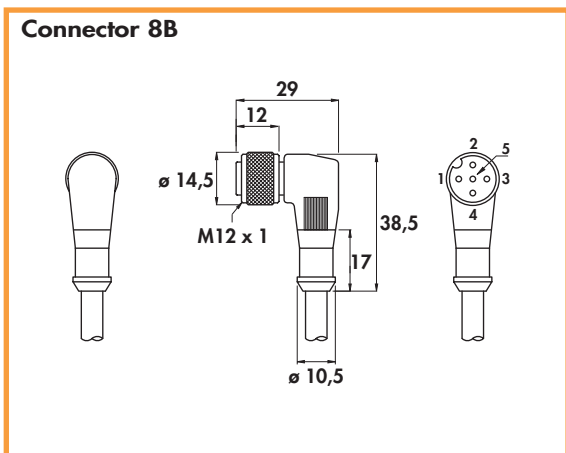

General Features:

Female connectors of this section can be matched to the proximity sensors as indicated on the ordering references tables of the products. They must be separately ordered.

Particular moulding processes assure the maximum sealing, making these products suitable even for heavy applications. The self securing locking nut assures the resistance to vibrations.

The two wires version can be used with all the two wires d.c. sensors either in N.O. or N.C. versions. The shielded version offers a shielding connected to the external nut. Grey moulding and cable are available upon request.

Technical data:

- Operating voltage: max 50 Vac/75 Vdc
- Maximum current: 4 A
- Contact resistance: $\leq 5 \text{ m}\Omega$
- Contacts: CuZn, brass pre-nickel and gold plated (0,8 μm)
- Moulding: orange PUR
- Locking nut: selflocking in CuZn, nickel plated brass
- O-Ring: NBR
- Temperature range: $-25^\circ \div +90^\circ \text{C}$
- Degree of protection: IP68 with plug in fully locked position

Connector n°		ORDERING REFERENCES				
		Cable				
		2 wires	3 wires	4 wires	5 wires + shield	
Section	2 x 0,75 mm ² - \varnothing ext. 5 (blue)	3 x 0,50 mm ² - \varnothing ext. 5	4 x 0,35 mm ² - \varnothing ext. 5	5 x 0,22 mm ² - \varnothing ext. 5		
Material	1) brown + 2) blue - 3) - 4) -	1) brown + 2) black - output 3) blue -	1) brown + 2) black - output NO 3) white - output NC 4) blue -	1) brown + 2) black - output NO 3) white - output NC 4) grey - signal 5) blue -		
Length m.						
8B	PVC	2	C8B/0022PV	C8B/0032PV	C8B/0042PV	C8B/0052VS
8B	PVC	5	C8B/0025PV	C8B/0035PV	C8B/0045PV	C8B/0055VS
8B	PVC	10	C8B/00210PV	C8B/00310PV	C8B/00410PV	C8B/00510VS
8B	PUR	2	C8B/0022PR	C8B/0032PR	C8B/0042PR	-
8B	PUR	5	C8B/0025PR	C8B/0035PR	C8B/0045PR	-
8B	PUR	10	C8B/00210PR	C8B/00310PR	C8B/00410PR	-

- Angled in d.c. with LED •
- Moulded with cable •
- According to EN 60947-5-2 •

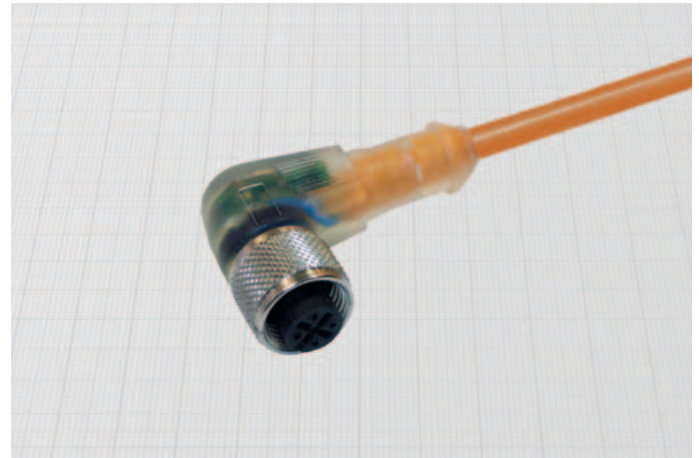
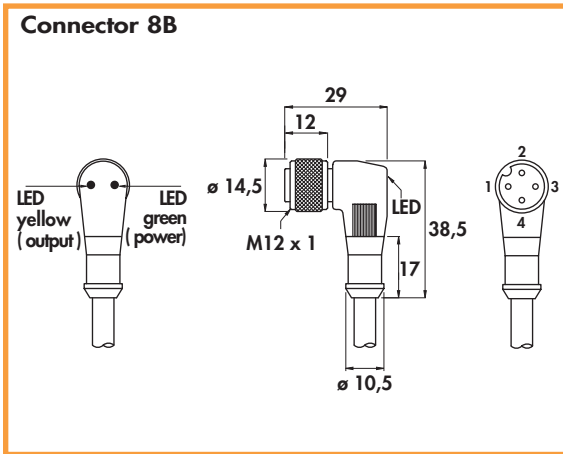

General Features:

Female connectors of this section can be matched to the proximity sensors as indicated on the ordering references tables of the products. They must be separately ordered. Thank to the implemented circuit, they allow to use the whole range of power supply of BDC sensors from 5 to 60 Vdc. Particular moulding processes assure the maximum sealing, making these products suitable even for heavy applications. The self securing locking nut assures the resistance to vibrations. Grey moulding and cable are available upon request.

Technical data:

- Operating voltage: 5 ÷ 60 Vdc
- Maximum current: 4 A
- Power consumption: 8 mA at 24 V
- Contact resistance: ≤ 5 mΩ
- Contacts: CuZn, brass pre-nickel and gold plated (0,8 μm)
- Moulding: transparent PUR
- Locking nut: self-locking in CuZn, nickel plated brass
- O-Ring: NBR
- Temperature range: - 25° ÷ + 90° C
- Degree of protection: IP68 with plug in fully locked position

Connector n°	Cable	ORDERING REFERENCES				
		3 wires		4 wires		
	Section	3 x 0,50 mm ² - ø ext. 5		4 x 0,35 mm ² - ø ext. 5		
	Material	Length m.	PNP	NPN	PNP	NPN
8B	PVC	2				
8B	PVC	5	C8B/2P32PV	C8B/2N32PV	C8B/2P42PV	C8B/2N42PV
8B	PVC	10	C8B/2P35PV	C8B/2N35PV	C8B/2P45PV	C8B/2N45PV
8B	PVC	10	C8B/2P310PV	C8B/2N310PV	C8B/2P410PV	C8B/2N410PV
8B	PUR	2	C8B/2P32PR	C8B/2N32PR	C8B/2P42PR	C8B/2N42PR
8B	PUR	5	C8B/2P35PR	C8B/2N35PR	C8B/2P45PR	C8B/2N45PR
8B	PUR	10	C8B/2P310PR	C8B/2N310PR	C8B/2P410PR	C8B/2N410PR

FEMALE CONNECTORS M12 x 1

- For high temperatures: (-40° ÷ +120°C)
- Straight and angled in d.c.
- Moulded with cable
- According to EN 60947-5-2

Connector 10

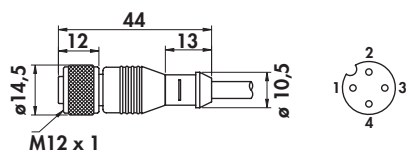

Connector 8B

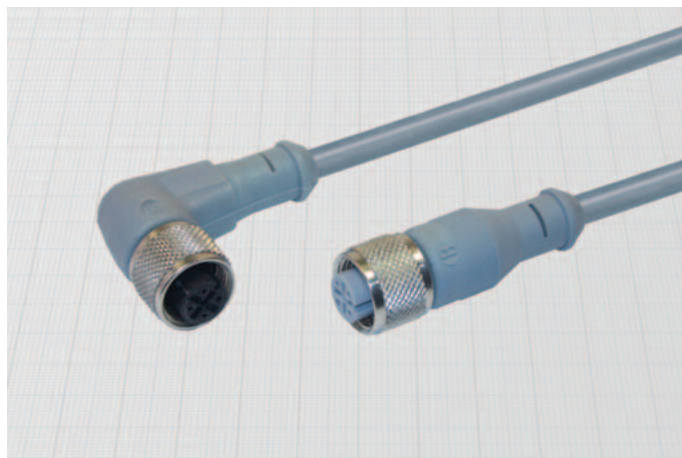
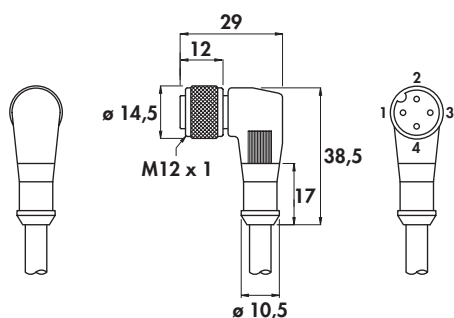

General Features:

These female connectors are suitable for the use with BDC high temperature proximity sensors. They must be separately ordered. Particular moulding processes assure the maximum sealing, making these products suitable even for heavy applications. The self securing locking nut assures the resistance to vibrations.

Technical data:

- Operating voltage: max 50 Vac/75 Vdc
- Maximum current: 4 A
- Contact resistance: ≤ 5 mΩ
- Contacts: CuZn, brass pre-nickel and gold plated (0,8 µm)
- Locking nut: selflocking in CuZn, nickel plated brass
- Temperature range: -40° ÷ +120°C
- Degree of protection: IP68 with plug in fully locked position

Connector n°	Cable	ORDERING REFERENCES	
		3 wires	4 wires
	Section	3 x 0,50 mm ² - ø ext. 5	4 x 0,35 mm ² - ø ext. 5
Length m.	1 > brown + 4 > black output 3 > blue -	1 > brown + 4 > black output NO 2 > white output NC 3 > blue -	
10	2	C10/0032T	C10/0042T
10	5	C10/0035T	C10/0045T
10	10	C10/00310T	C10/00410T
8B	2	C8B/0032T	C8B/0042T
8B	5	C8B/0035T	C8B/0045T
8B	10	C8B/00310T	C8B/00410T

Per sensori ATEX •

Diritti in c.c. •

Costampati con cavo •

Conformi a 94/9/CE - EN60079-0 - EN 60947-5-2 •

Connettore 10B

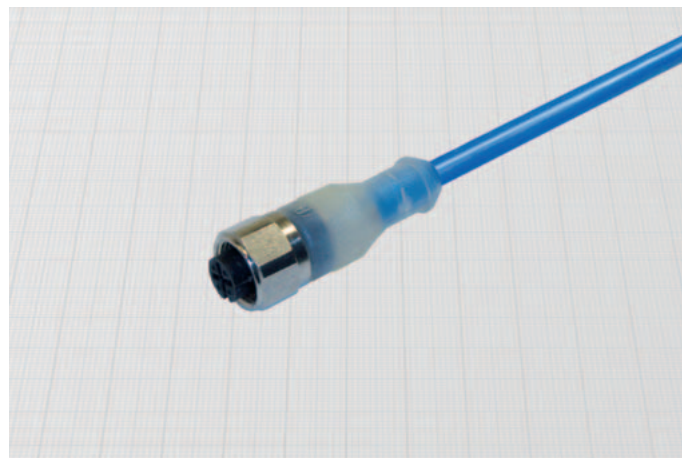
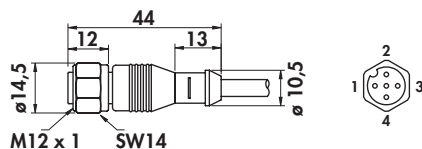

Generalità:

I connettori femmina di questa serie sono da abbinare ai sensori ATEX BDC a seconda della categoria di utilizzo, come indicato dalla tabella.

Devono essere ordinati separatamente.

Il modello a 2 fili è adatto a tutti i sensori NAMUR sia nella versione N.A. che nella versione N.C. È possibile utilizzarlo in zona 0 o 20 senza protezioni supplementari contro le cariche elettrostatiche.

Particolari procedimenti di stampaggio garantiscono la massima tenuta ermetica rendendo questi prodotti adatti alle più severe condizioni di utilizzo.

Nota: per l'installazione attenersi scrupolosamente alle istruzioni di installazione per area pericolosa fornite assieme al sensore.

Caratteristiche tecniche:

- Tensione di lavoro: max 50 Vca/75 Vcc
- Corrente max: 4 A
- Resistenza di contatto: ≤ 5 mΩ
- Contatti: CuZn, ottone pre-nichelato e placcato in oro (0,8 μm)
- Ghiera: autobloccante in CuZn, ottone nichelato
- Campo di temperatura: -25° ÷ +90°C
- Grado di protezione: IP68 con ghiera di fissaggio bloccata a fondo

		CODICI DI ORDINAZIONE		
Connettore n°	Categoria	1G-1D	3G-3D	3G-3D
	Zona	0-20	2-22	2-22
	Cap. cavo pF/m	140	170	170
	Indutt. cavo μH/m	0,4	0,8	0,8
	Cavo	2 Fili (blu)	3 Fili (grigio)	4 Fili (grigio)
	Sezione	2 x 0,75 mm ² - ø est. 5	3 x 0,50 mm ² - ø est. 5	4 x 0,35 mm ² - ø est. 5
	Materiale	Lunghezza m.		
10B PVC	2	C10/0022PVA	C10/0032PV3GD	C10/0042PV3GD
10B PVC	5	C10/0025PVA	C10/0035PV3GD	C10/0045PV3GD
10B PVC	10	C10/00210PVA	C10/00310PV3GD	C10/00410PV3GD
10B PUR	2	C10/0022PRA	C10/0032PR3GD	C10/0042PR3GD
10B PUR	5	C10/0025PRA	C10/0035PR3GD	C10/0045PR3GD
10B PUR	10	C10/00210PRA	C10/00310PR3GD	C10/00410PR3GD

CONNETTORI FEMMINA M12 x 1

- Per sensori ATEX
- Angolari in c.c.
- Costampati con cavo
- Conformi a 94/9/CE - EN60079-0 - EN60947-5-2

Connettore 8B

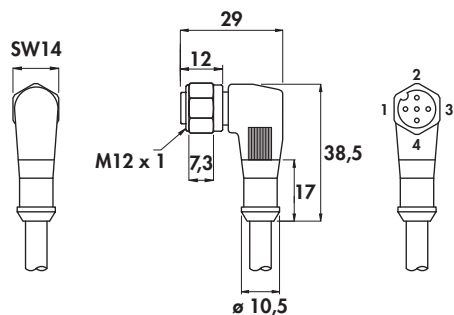

Generalità:

I connettori femmina di questa serie possono essere abbinati ai sensori ATEX BDC a seconda della categoria di utilizzo, come indicato dalla tabella.

Devono essere ordinati separatamente.

Il modello a 2 fili è adatto a tutti i sensori NAMUR sia nella versione N.A. che nella versione N.C. È possibile utilizzarlo in zona 1 o 21 senza protezioni supplementari contro le cariche elettrostatiche.

Particolari procedimenti di stampaggio garantiscono la massima tenuta ermetica rendendo questi prodotti adatti alle più severe condizioni di utilizzo.

Nota: per l'installazione attenersi scrupolosamente alle istruzioni di installazione per area pericolosa.

Caratteristiche tecniche:

- Tensione di lavoro: max 50 Vca/75 Vcc
- Corrente max: 4 A
- Resistenza di contatto: $\leq 5 \text{ m}\Omega$
- Contatti: CuZn, ottone pre-nichelato e placcato in oro (0,8 μm)
- Ghiera: autobloccante in CuZn, ottone nichelato
- Campo di temperatura: $-25^\circ \div +90^\circ\text{C}$
- Grado di protezione: IP68 con ghiera di fissaggio bloccata a fondo

CODICI DI ORDINAZIONE

Connettore n°	CODICI DI ORDINAZIONE				
	Categoria	2G-2D	3G-3D	3G-3D	
	Zona	1-21	2-22	2-22	
	Cap. cavo pF/m	140	170	170	
	Indutt. cavo $\mu\text{H}/\text{m}$	0,4	0,8	0,8	
	Cavo	2 Fili (blu)	3 Fili (grigio)	4 Fili (grigio)	
	Sezione	2 x 0,75 mm ² - ø est. 5	3 x 0,50 mm ² - ø est. 5	4 x 0,35 mm ² - ø est. 5	
Materiale					
Lunghezza m.	1) marrone + 2) blu - 4)	1) marrone + 4) nero - uscita 2) blu - 3)	1) marrone + 4) nero - uscita NA 2) bianco - uscita NC 3) blu -		
8B	PVC	2	C8B/0022PVA	C8B/0032PV3GD	C8B/0042PV3GD
8B	PVC	5	C8B/0025PVA	C8B/0035PV3GD	C8B/0045PV3GD
8B	PVC	10	C8B/00210PVA	C8B/00310PV3GD	C8B/00410PV3GD
8B	PUR	2	C8B/0022PRA	C8B/0032PR3GD	C8B/0042PR3GD
8B	PUR	5	C8B/0025PRA	C8B/0035PR3GD	C8B/0045PR3GD
8B	PUR	10	C8B/00210PRA	C8B/00310PR3GD	C8B/00410PR3GD

For a.c. sensors •
 Straight and angled with double reference key •
 Moulded with cable •
 According to EN 60947-5-2 •

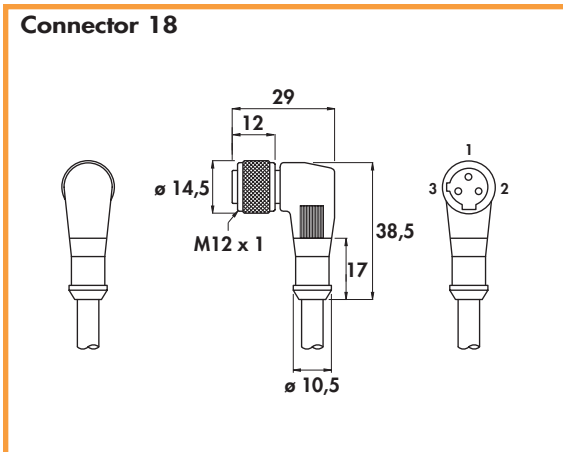
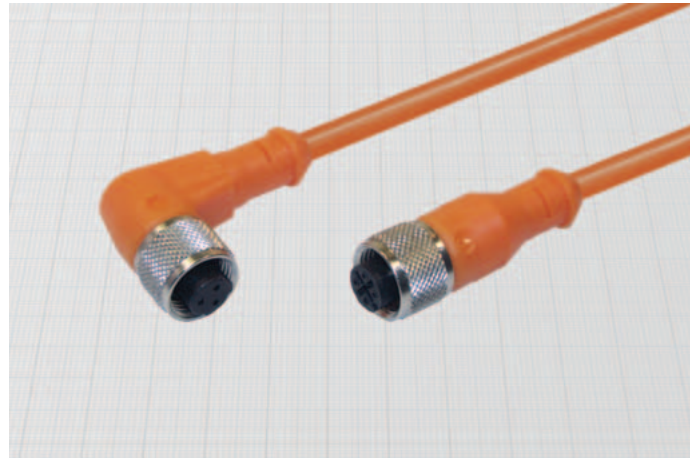
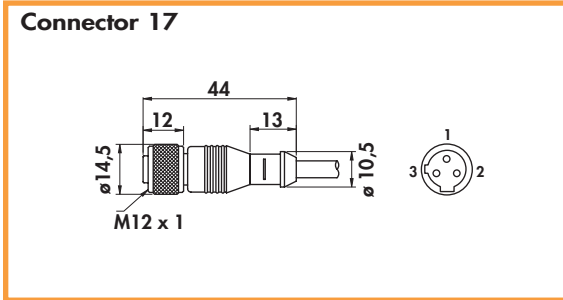

General Features:

Female connectors of this section can be matched to the proximity sensors as indicated on the ordering references tables of the products. They must be separately ordered. These models are suitable for all the a.c. sensors with M12x1 double reference key exit.

Particular moulding processes assure the maximum sealing, making these products suitable even for heavy applications. The self securing locking nut assures the resistance to vibrations.

Technical data:

- Operating voltage: max 250 Vac/Vdc
- Maximum current: 4 A
- Contact resistance: ≤ 5 mΩ
- Contacts: CuZn, brass pre-nickeled and gold plated (0,8 μm)
- Moulding: orange PUR
- Locking nut: self-locking in CuZn, nickel plated brass
- O-Ring: NBR
- Temperature range: - 25° ÷ + 90°C
- Degree of protection: IP68 with plug in fully locked position

Connector n°	Cable		ORDERING REFERENCES
	Section		
	Material	Length m.	
			3 - blue ~ 2 - brown ~ 1 - yellow/green ⊕
17	PVC	2	C17/0032PV
17	PVC	5	C17/0035PV
17	PVC	10	C17/00310PV
17	PUR	2	C17/0032PR
17	PUR	5	C17/0035PR
17	PUR	10	C17/00310PR
18	PVC	2	C18/0032PV
18	PVC	5	C18/0035PV
18	PVC	10	C18/00310PV
18	PUR	2	C18/0032PR
18	PUR	5	C18/0035PR
18	PUR	10	C18/00310PR

FEMALE CONNECTORS M12 x 1

- For a.c. sensors
- Straight and angled single key
- Moulded with cable

Connector 15

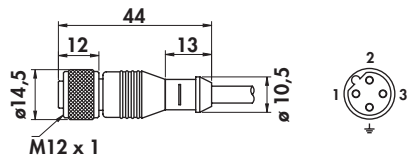

Connector 16

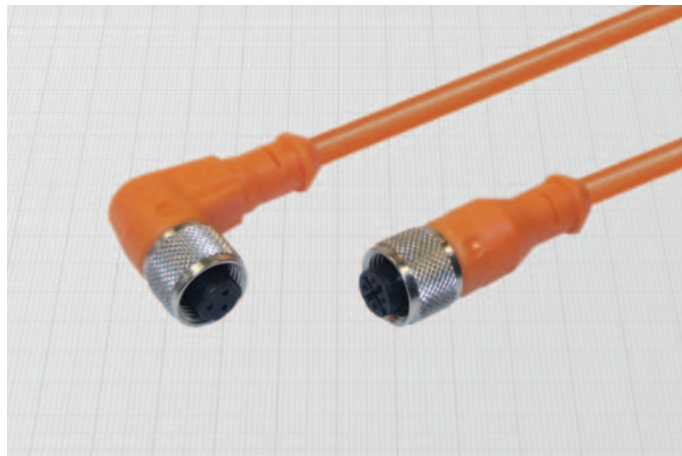
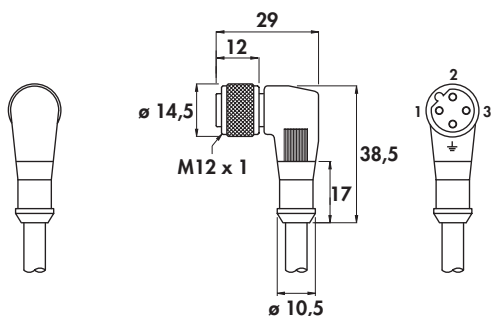

General Features:

Female connectors of this section can be matched to the proximity sensors as indicated on the ordering references tables of the products. They must be separately ordered. These models are suitable for all the a.c. sensors with M12x1, 4 pin, single key exit.

Particular moulding processes assure the maximum sealing, making these products suitable even for heavy applications. The self securing locking nut assures the resistance to vibrations.

Technical data:

- Operating voltage: max 250 Vac/Vdc
- Maximum current: 4 A
- Contact resistance: $\leq 5 \text{ m}\Omega$
- Contacts: CuZn, brass pre-nickeled and gold plated (0,8 μm)
- Moulding: orange PUR
- Locking nut: self-locking in CuZn, nickel plated brass
- O-Ring: NBR
- Temperature range: $-25^\circ \div +90^\circ\text{C}$
- Degree of protection: IP68 with plug in fully locked position

Connector n°	Cable		ORDERING REFERENCES
	Section		
	Material	Length m.	
			3 x 0,35 mm ² - \varnothing ext. 5
			1 > brown ~ 2 > blue ~ 3 > yellow/green ~ 4 > ~
15	PVC	2	C15/0032PV
15	PVC	5	C15/0035PV
15	PVC	10	C15/00310PV
15	PUR	2	C15/0032PR
15	PUR	5	C15/0035PR
15	PUR	10	C15/00310PR
16	PVC	2	C16/0032PV
16	PVC	5	C16/0035PV
16	PVC	10	C16/00310PV
16	PUR	2	C16/0032PR
16	PUR	5	C16/0035PR
16	PUR	10	C16/00310PR

Straight in d.c. •
Moulded with cable •
 According to EN 60947-5-2 •

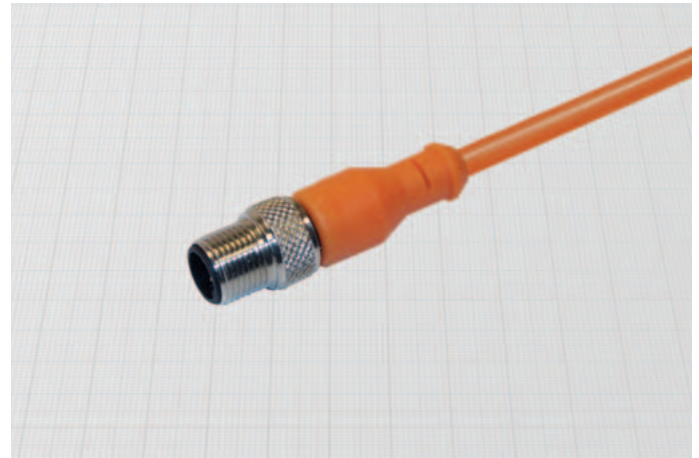
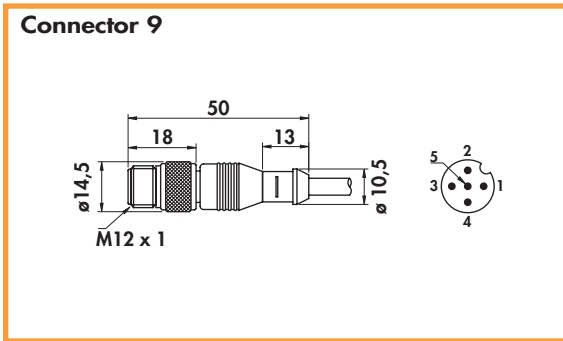

General Features:

Particular moulding processes assure the maximum sealing, making these products suitable even for heavy applications. The self securing locking nut assures the resistance to vibrations. The shielded version offers a complete 360° shielding connected to the external nut. Grey moulding and cable are available upon request.

Technical data:

- Operating voltage: max 50 Vac/75 Vdc
- Maximum current: 4 A
- Contact resistance: $\leq 5 \text{ m}\Omega$
- Contacts: CuZn, brass pre-nickeled and gold plated (0,8 μm)
- Moulding: orange PUR
- Locking nut: self-locking in CuZn, nickel plated brass
- Temperature range: $-25^\circ \div +90^\circ\text{C}$
- Degree of protection: IP68 with plug in fully locked position

Connector n°	Cable	ORDERING REFERENCES						
		3 wires		4 wires		5 wires + shield		
		3 x 0,50 mm ² - \varnothing ext. 5		4 x 0,35 mm ² - \varnothing ext. 5		5 x 0,22 mm ² - \varnothing ext. 5		
Material	Length m.	1) brown + 4) black output NO 2) white output NC 3) blue -		1) brown + 4) black output NO 2) white output NC 5) grey signal 3) blue -				
9	PVC	2	C9/0032PV		C9/0042PV		C9/0052VS	
9	PVC	5	C9/0035PV		C9/0045PV		C9/0055VS	
9	PVC	10	C9/00310PV		C9/00410PV		C9/00510VS	
9	PUR	2	C9/0032PR		C9/0042PR		-	
9	PUR	5	C9/0035PR		C9/0045PR		-	
9	PUR	10	C9/00310PR		C9/00410PR		-	

MALE CONNECTORS M12 x 1

- Angled in d.c.
- Moulded with cable
- According to EN 60947-5-2

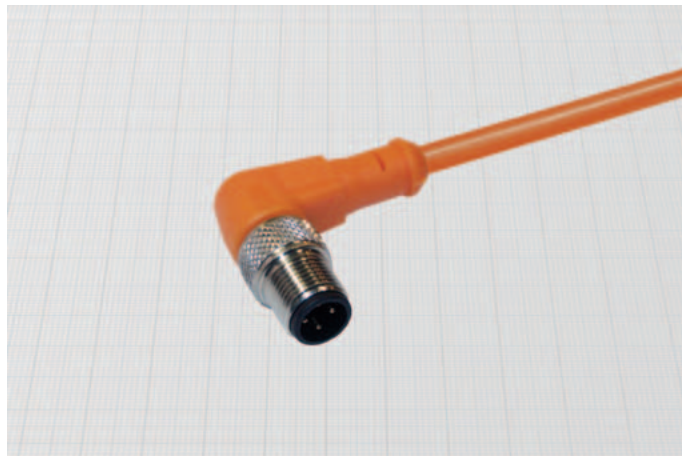
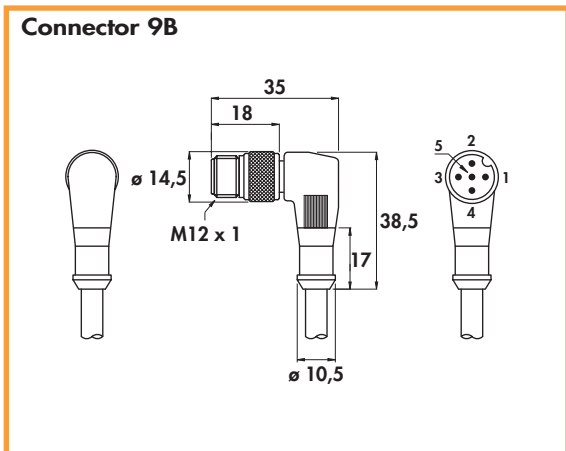

General Features:

Particular moulding processes assure the maximum sealing, making these products suitable even for heavy applications. The self securing locking nut assures the resistance to vibrations.

The shielded version offers a shielding connected to the external nut. Grey moulding and cable are available upon request.

Technical data:

- Operating voltage: max 50 Vac / 75 Vdc
- Maximum current: 4 A
- Contact resistance: $\leq 5 \text{ m}\Omega$
- Contacts: CuZn, brass pre-nickel and gold plated (0,8 μm)
- Moulding: orange PUR
- Locking nut: selflocking in CuZn, nickel plated brass
- Temperature range: $-25^\circ \div +90^\circ\text{C}$
- Degree of protection: IP68 with plug in fully locked position

Connector n°	ORDERING REFERENCES				
	Cable				
		3 wires	4 wires	5 wires + shield	
	Section	3 x 0,50 mm ² - \varnothing ext. 5	4 x 0,35 mm ² - \varnothing ext. 5	5 x 0,22 mm ² - \varnothing ext. 5	
Material	1 > brown + 4 > black output 3 > blue -	1 > brown + 4 > black output NO 2 > white output NC 3 > blue -	1 > brown + 4 > black output NO 2 > white output NC 5 > grey signal 3 > blue -		
Length m.					
9B	PVC	2	C9B/0032PV	C9B/0042PV	C9B/0052VS
9B	PVC	5	C9B/0035PV	C9B/0045PV	C9B/0055VS
9B	PVC	10	C9B/00310PV	C9B/00410PV	C9B/00510VS
9B	PUR	2	C9B/0032PR	C9B/0042PR	-
9B	PUR	5	C9B/0035PR	C9B/0045PR	-
9B	PUR	10	C9B/00310PR	C9B/00410PR	-

CONNECTING CABLES FOR SENSORS



CONNECTING CABLES

N° Male connector:
8M = straight M8 x 1
9 = straight M12 x 1
9B = angled M12 x 1

N° Female connector:
8B = angled M12 x 1
10 = straight M12 x 1
11 = straight M8 x 1
12 = angled M8 x 1

C9	/	C10	/	00	3	-	0,6	PV
-----------	----------	------------	----------	-----------	----------	----------	------------	-----------

00 = without LED
2P = 2 LED PNP
2N = 2 LED NPN

N° conductors:
3 = 3 wires
4 = 4 wires
5 = 5 wires

Cable length
0,6 = 0,6 m
1 = 1 m
2 = 2 m
 Other cable lengths upon request

Cable material:
PV = PVC (orange)
PR = PUR (orange)
VS = PVC shielded

MALE M8 x 1 •
FEMALE M8 x 1 •

According to EN 60947-5-2 •

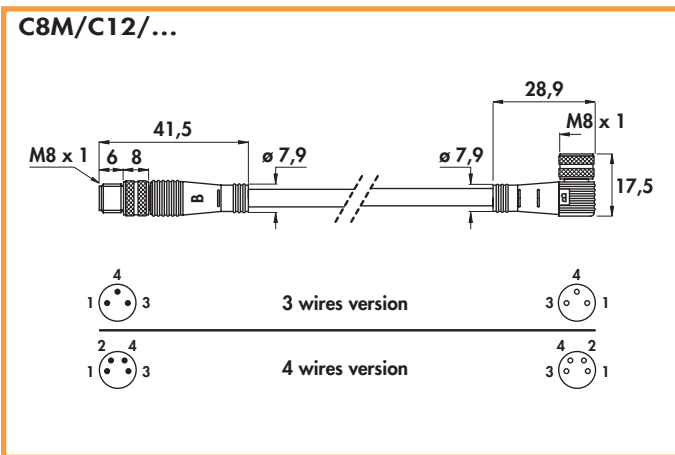
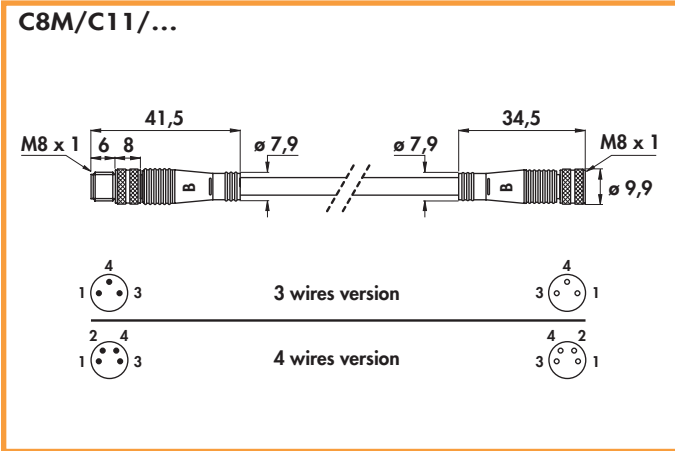

Technical data:

- Operating voltage: 10 ÷ 30 Vdc types with LED
max 50 Vac/75 Vdc types without LED
- Maximum current: 4 A
- Contact resistance: ≤ 5 mΩ
- Contacts: CuZn, brass pre-nickel and gold plated (0,8 μm)
- Moulding: PUR
- Locking nut: self-locking in CuZn, nickel plated brass
- Temperature range: -25 ÷ +90°C
- Degree of protection: IP68 with plug in fully locked position

Cable		ORDERING REFERENCES			
Material	Length m.	3 wires		4 wires	
		• Straight male • Straight female	• Straight male • Angled female (*)	• Straight male • Straight female	• Straight male • Angled female
PVC	0,6	C8M/C11/003-0,6PV	C8M/C12/003-0,6PV	C8M/C11/004-0,6PV	C8M/C12/004-0,6PV
PVC	1	C8M/C11/003-1PV	C8M/C12/003-1PV	C8M/C11/004-1PV	C8M/C12/004-1PV
PVC	2	C8M/C11/003-2PV	C8M/C12/003-2PV	C8M/C11/004-2PV	C8M/C12/004-2PV
PUR	0,6	C8M/C11/003-0,6PR	C8M/C12/003-0,6PR	C8M/C11/004-0,6PR	C8M/C12/004-0,6PR
PUR	1	C8M/C11/003-1PR	C8M/C12/003-1PR	C8M/C11/004-1PR	C8M/C12/004-1PR
PUR	2	C8M/C11/003-2PR	C8M/C12/003-2PR	C8M/C11/004-2PR	C8M/C12/004-2PR

(*) Note: for LED PNP option on female part substitute the part of the code .../00... with .../2P... i.e. **C8M/C12/2P3-0,6PV**
for LED NPN option on female part substitute the part of the code .../00... with .../2N... i.e. **C8M/C12/2N3-0,6PV**

CONNECTING CABLES FOR SENSORS

- **MALE M8 x 1**
- **FEMALE M12 x 1**
- According to EN 60947-5-2

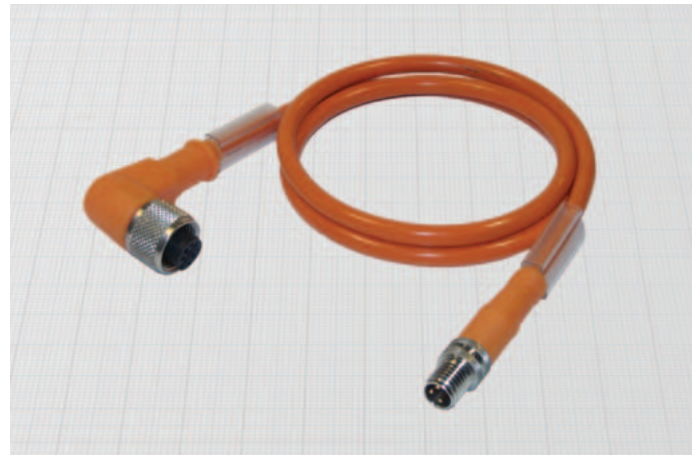
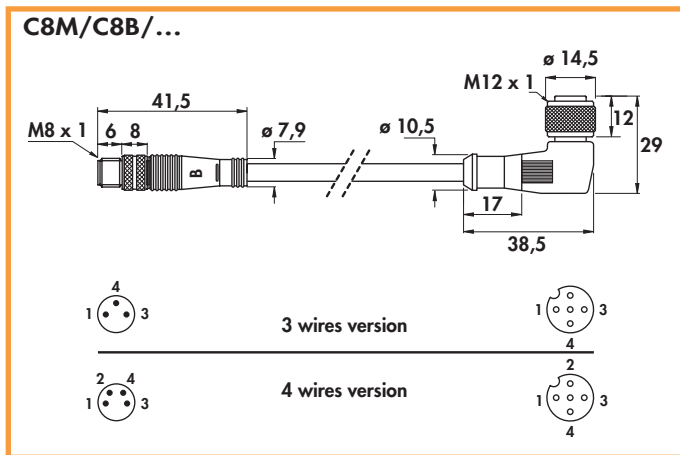
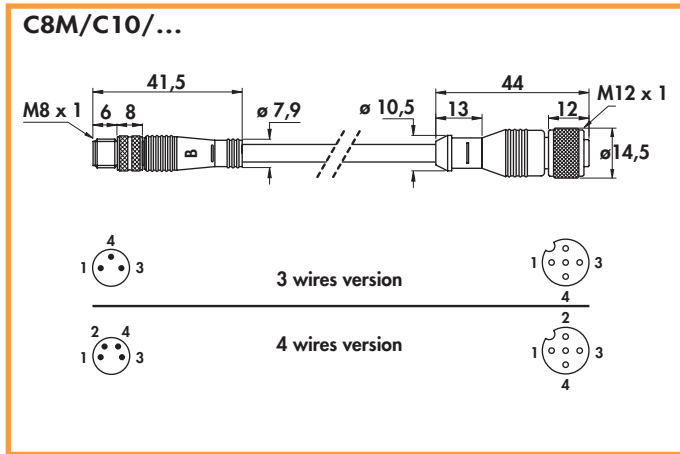

Technical data:

- Operating voltage: 10 ÷ 30 Vdc straight types with LED
5 ÷ 60 Vdc angled types with LED
max 50 Vac/75 Vdc types without LED
- Maximum current: 4 A
- Contact resistance: ≤ 5 mΩ
- Contacts: CuZn, brass pre-nickel and gold plated (0,8 μm)
- Moulding: PUR
- Locking nut: selflocking in CuZn, nickel plated brass
- Temperature range: -25 ÷ +90°C
- Degree of protection: IP67 with plug in fully locked position

Cable		ORDERING REFERENCES			
Material	Length m.	3 wires		4 wires	
		• Straight male • Straight female (*)	• Straight male • Angled female (*)	• Straight male • Straight female (*)	• Straight male • Angled female (*)
PVC	0,6	C8M/C10/003-0,6PV	C8M/C8B/003-0,6PV	C8M/C10/004-0,6PV	C8M/C8B/004-0,6PV
PVC	1	C8M/C10/003-1PV	C8M/C8B/003-1PV	C8M/C10/004-1PV	C8M/C8B/004-1PV
PVC	2	C8M/C10/003-2PV	C8M/C8B/003-2PV	C8M/C10/004-2PV	C8M/C8B/004-2PV
PUR	0,6	C8M/C10/003-0,6PR	C8M/C8B/003-0,6PR	C8M/C10/004-0,6PR	C8M/C8B/004-0,6PR
PUR	1	C8M/C10/003-1PR	C8M/C8B/003-1PR	C8M/C10/004-1PR	C8M/C8B/004-1PR
PUR	2	C8M/C10/003-2PR	C8M/C8B/003-2PR	C8M/C10/004-2PR	C8M/C8B/004-2PR

(*) Note: for LED PNP option on female part substitute the part of the code .../00... with .../2P... i.e. **C8M/C10/2P3-0,6PV**
for LED NPN option on female part substitute the part of the code .../00... with .../2N... i.e. **C8M/C10/2N3-0,6PV**

MALE M12 x 1 straight •
FEMALE M8 x 1 •
 According to EN 60947-5-2 •

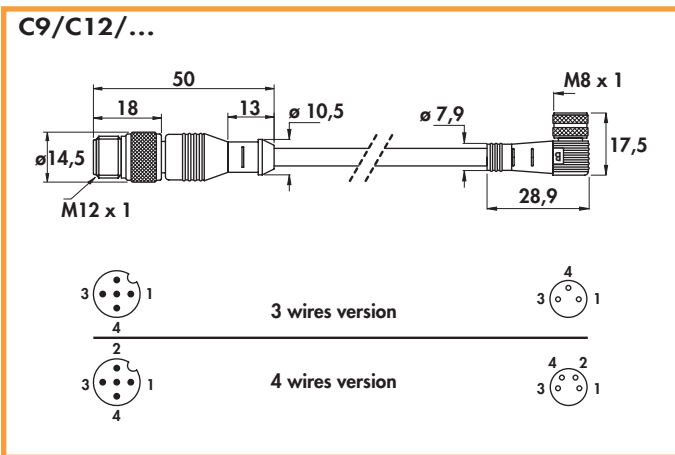
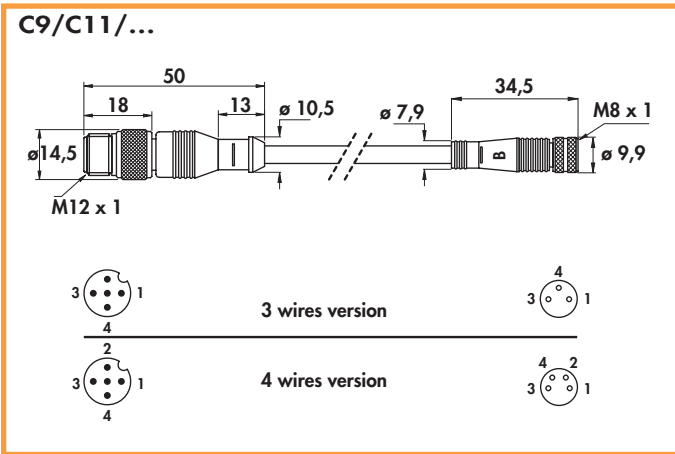

Technical data:

- Operating voltage: 10 ÷ 30 Vdc types with LED
max 50 Vac/75 Vdc types without LED
- Maximum current: 4 A
- Contact resistance: ≤ 5 mΩ
- Contacts: CuZn, brass pre-nickel and gold plated (0,8 μm)
- Moulding: PUR
- Locking nut: self-locking in CuZn, nickel plated brass
- Temperature range: -25 ÷ +90°C
- Degree of protection: IP68 with plug in fully locked position

Cable		ORDERING REFERENCES			
Material	Length m.	3 wires		4 wires	
		• Straight male • Straight female	• Straight male • Angled female (*)	• Straight male • Straight female	• Straight male • Angled female
PVC	0,6	C9/C11/003-0,6PV	C9/C12/003-0,6PV	C9/C11/004-0,6PV	C9/C12/004-0,6PV
PVC	1	C9/C11/003-1PV	C9/C12/003-1PV	C9/C11/004-1PV	C9/C12/004-1PV
PVC	2	C9/C11/003-2PV	C9/C12/003-2PV	C9/C11/004-2PV	C9/C12/004-2PV
PUR	0,6	C9/C11/003-0,6PR	C9/C12/003-0,6PR	C9/C11/004-0,6PR	C9/C12/004-0,6PR
PUR	1	C9/C11/003-1PR	C9/C12/003-1PR	C9/C11/004-1PR	C9/C12/004-1PR
PUR	2	C9/C11/003-2PR	C9/C12/003-2PR	C9/C11/004-2PR	C9/C12/004-2PR

(*) Note: for LED PNP option on female part substitute the part of the code .../00... with .../2P... i.e. **C9/C12/2P3-0,6PV**
 for LED NPN option on female part substitute the part of the code .../00... with .../2N... i.e. **C9/C12/2N3-0,6PV**

CONNECTING CABLES FOR SENSORS

- **MALE M12 x 1 angled**
- **FEMALE M8 x 1**
- According to EN 60947-5-2

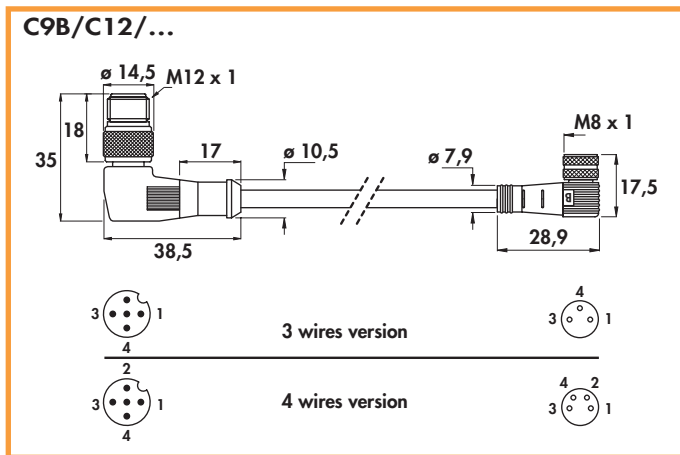
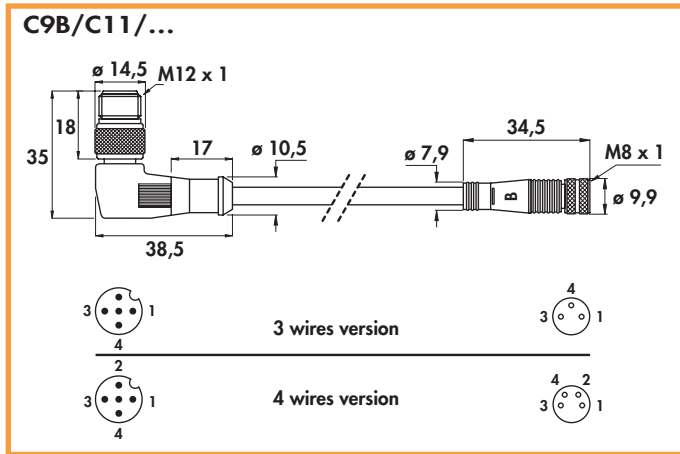

Technical data:

- Operating voltage: 10 ÷ 30 Vdc types with LED
max 50 Vac/75 Vdc types without LED
- Maximum current: 4 A
- Contact resistance: $\leq 5 \text{ m}\Omega$
- Contacts: CuZn, brass pre-nickelated and gold plated (0,8 μm)
- Moulding: PUR
- Locking nut: selflocking in CuZn, nickel plated brass
- Temperature range: -25 ÷ +90°C
- Degree of protection: IP68 with plug in fully locked position

Cable		ORDERING REFERENCES			
Material	Length m.	3 wires		4 wires	
		• Angled male • Straight female	• Angled male • Angled female (*)	• Angled male • Straight female	• Angled male • Angled female
PVC	0,6	C9B/C11/003-0,6PV	C9B/C12/003-0,6PV	C9B/C11/004-0,6PV	C9B/C12/004-0,6PV
PVC	1	C9B/C11/003-1PV	C9B/C12/003-1PV	C9B/C11/004-1PV	C9B/C12/004-1PV
PVC	2	C9B/C11/003-2PV	C9B/C12/003-2PV	C9B/C11/004-2PV	C9B/C12/004-2PV
PUR	0,6	C9B/C11/003-0,6PR	C9B/C12/003-0,6PR	C9B/C11/004-0,6PR	C9B/C12/004-0,6PR
PUR	1	C9B/C11/003-1PR	C9B/C12/003-1PR	C9B/C11/004-1PR	C9B/C12/004-1PR
PUR	2	C9B/C11/003-2PR	C9B/C12/003-2PR	C9B/C11/004-2PR	C9B/C12/004-2PR

(*) Note: for LED PNP option on female part substitute the part of the code .../00... with .../2P... i.e. **C9B/C12/2P3-0,6PV**
for LED NPN option on female part substitute the part of the code .../00... with .../2N... i.e. **C9B/C12/2N3-0,6PV**

MALE M12 x 1 straight •
FEMALE M12 x 1 •
 According to EN 60947-5-2 •

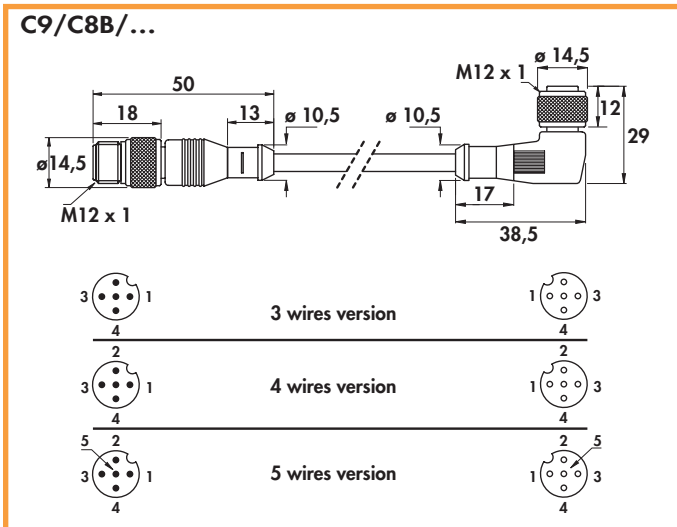
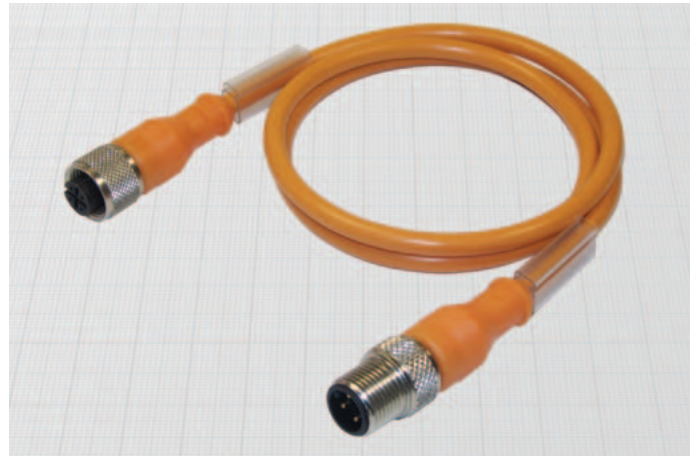
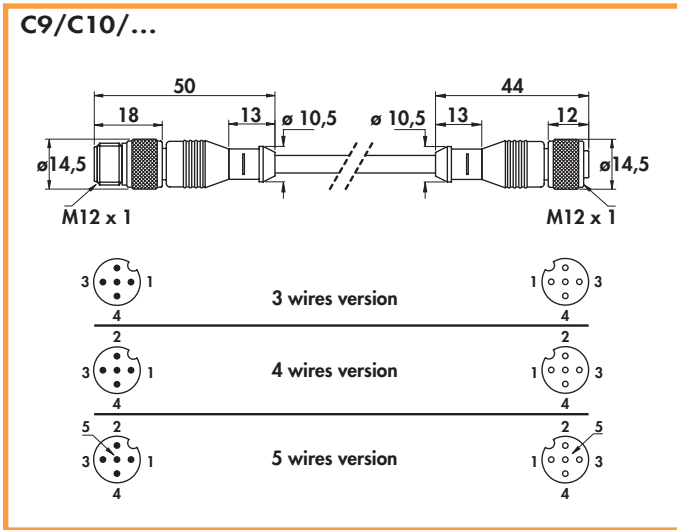

Technical data:

- Operating voltage: 10 ÷ 30 Vdc straight types with LED
5 ÷ 60 Vdc angled types with LED
max 50 Vac/75 Vdc types without LED
- Maximum current: 4 A
- Contact resistance: ≤ 5 mΩ
- Contacts: CuZn, brass pre-nickel and gold plated (0,8 μm)
- Moulding: PUR
- Locking nut: self-locking in CuZn, nickel plated brass
- Temperature range: - 25 ÷ + 90°C
- Degree of protection: IP68 with plug in fully locked position

Cable		ORDERING REFERENCES			
Material	Length m.	3 wires		4 wires	
		• Straight male • Straight female (*)	• Straight male • Angled female (*)	• Straight male • Straight female (*)	• Straight male • Angled female (*)
PVC	0,6	C9/C10/003-0,6PV	C9/C8B/003-0,6PV	C9/C10/004-0,6PV	C9/C8B/004-0,6PV
PVC	1	C9/C10/003-1PV	C9/C8B/003-1PV	C9/C10/004-1PV	C9/C8B/004-1PV
PVC	2	C9/C10/003-2PV	C9/C8B/003-2PV	C9/C10/004-2PV	C9/C8B/004-2PV
PUR	0,6	C9/C10/003-0,6PR	C9/C8B/003-0,6PR	C9/C10/004-0,6PR	C9/C8B/004-0,6PR
PUR	1	C9/C10/003-1PR	C9/C8B/003-1PR	C9/C10/004-1PR	C9/C8B/004-1PR
PUR	2	C9/C10/003-2PR	C9/C8B/003-2PR	C9/C10/004-2PR	C9/C8B/004-2PR

Note: For 5 wires version substitute the number before the cable length with 5. i.e. **C9/C10/005-0,6PV**
 (*) for LED PNP option on female part substitute the part of the code .../00... with .../2P... i.e. **C9/C10/2P3-0,6PV**
 for LED NPN option on female part substitute the part of the code .../00... with .../2N... i.e. **C9/C10/2N3-0,6PV**

CONNECTING CABLES FOR SENSORS

- **MALE M12 x 1 angled**
- **FEMALE M12 x 1**
- According to EN 60947-5-2

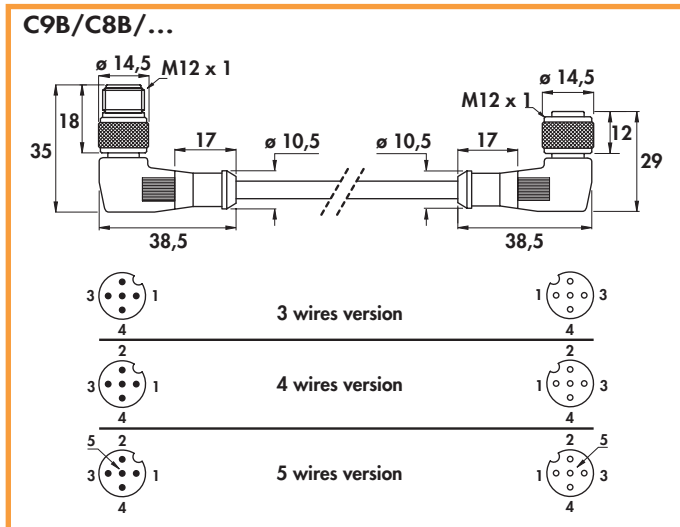
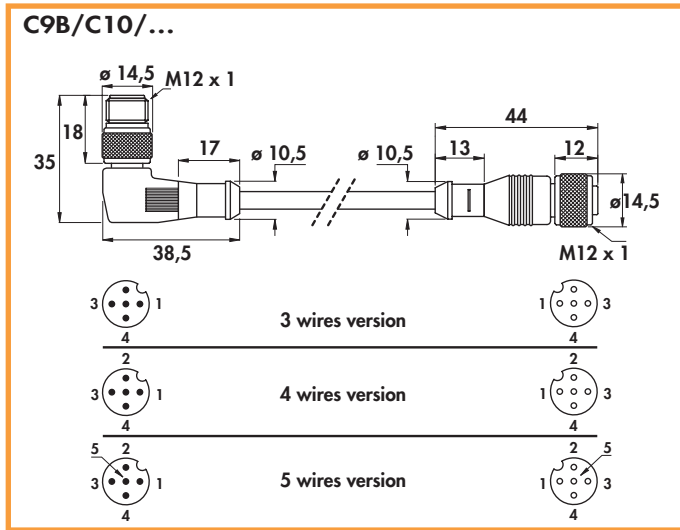

Technical data:

- Operating voltage: 10 ÷ 30 Vdc straight types with LED
5 ÷ 60 Vdc types angled with LED
max 50 Vac/75 Vdc types without LED
- Maximum current: 4 A
- Contact resistance: ≤ 5 mΩ
- Contacts: CuZn, brass pre-nickel and gold plated (0,8 μm)
- Moulding: PUR
- Locking nut: self-locking in CuZn, nickel plated brass
- Temperature range: -25 ÷ +90°C
- Degree of protection: IP68 with plug in fully locked position

Cable		ORDERING REFERENCES			
Material	Length m.	3 wires		4 wires	
		• Angled male • Straight female (*)	• Angled male • Angled female (*)	• Angled male • Straight female (*)	• Angled male • Angled female (*)
PVC	0,6	C9B/C10/003-0,6PV	C9B/C8B/003-0,6PV	C9B/C10/004-0,6PV	C9B/C8B/004-0,6PV
PVC	1	C9B/C10/003-1PV	C9B/C8B/003-1PV	C9B/C10/004-1PV	C9B/C8B/004-1PV
PVC	2	C9B/C10/003-2PV	C9B/C8B/003-2PV	C9B/C10/004-2PV	C9B/C8B/004-2PV
PUR	0,6	C9B/C10/003-0,6PR	C9B/C8B/003-0,6PR	C9B/C10/004-0,6PR	C9B/C8B/004-0,6PR
PUR	1	C9B/C10/003-1PR	C9B/C8B/003-1PR	C9B/C10/004-1PR	C9B/C8B/004-1PR
PUR	2	C9B/C10/003-2PR	C9B/C8B/003-2PR	C9B/C10/004-2PR	C9B/C8B/004-2PR

Note: For 5 wires version substitute the number before the cable length with 5. i.e. **C9B/C10/005-0,6PV**
 (*) for LED PNP option on female part substitute the part of the code .../00... with .../2P... i.e. **C9B/C10/2P3-0,6PV**
 for LED NPN option on female part substitute the part of the code .../00... with .../2N... i.e. **C9B/C10/2N3-0,6PV**

Connector 1

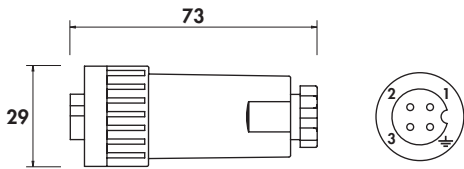

Straight •
for housings M-1/M-2/M-4/M-5 •

Connector 2

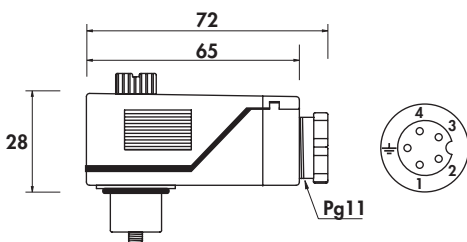

Angled •
for housings M/M-3/M-6 •

Connector 6

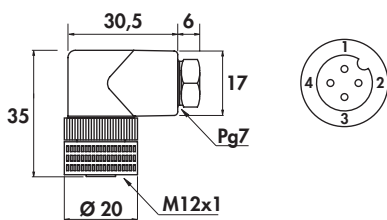

Angled M12x1 •
according to EN60947-5-2 •

General features:

Female connectors of this section can be matched to the proximity sensors as indicated on the ordering references tables of the products. They must be separately ordered. These models are without cable. They all have screw clamps for an easy assembling on the field.

CONNECTOR N°	MODEL	TYPE	DEGREE OF PROTECTION	ORDERING REFERENCES
1	Amphenol	T3109-000	IP 65	C1/00
2	Amphenol	C 164	IP 65	C2/00
6	Hirschmann	ELWIK4 4012	IP 65	C6/00

INFORMATION TRANSPORT



ERB 1 •
Fixed code identification system •

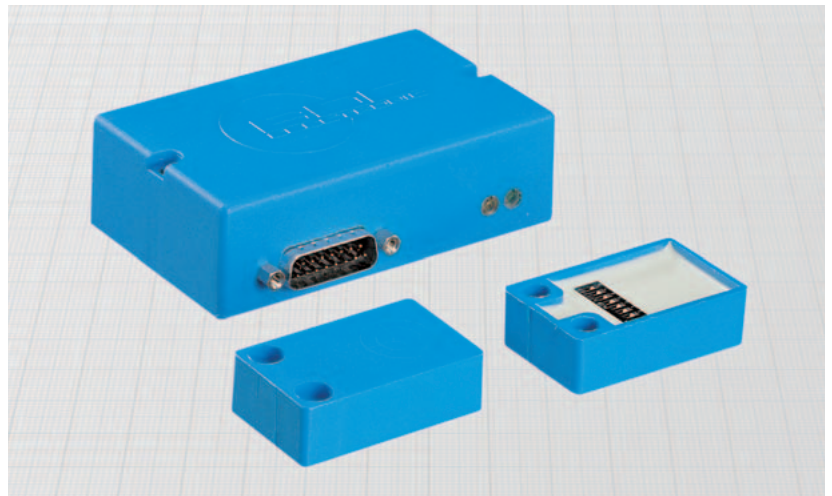
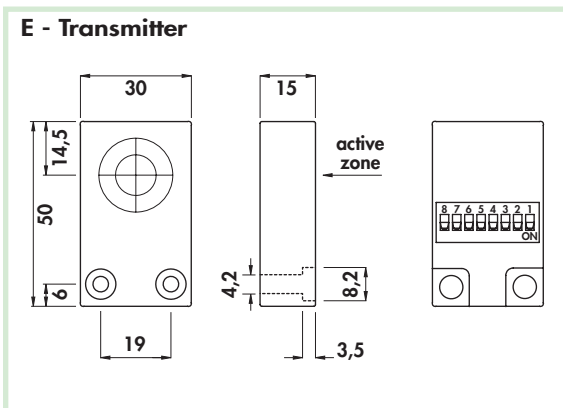
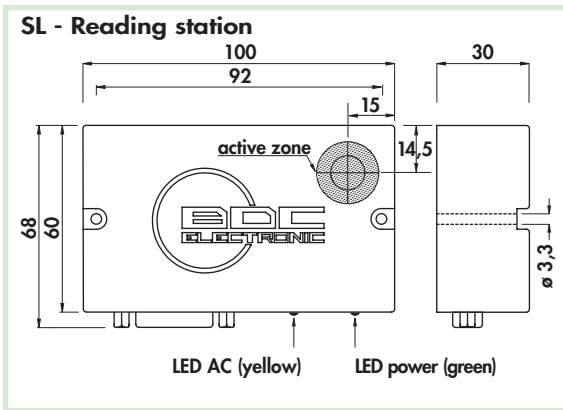

General Features:

This system allows to assign an identification code to the fixed or mobile parts. The code holder is the transmitter and it works with no need of power supply. The code reading is done by the reading station, which makes it available on the parallel port, allowing an easy and cheap connection to any PLC.

The transmitted word is of 8bit (for a total of 256 codes) and the transmission happens when the two parts face together. This code is single and it can be set up using the dip-switches on the back of the transmitter. On the parallel port we have the code read in binary code. The parallel port holds the output data even when the transmitter is gone and is cleared only by sending a reset signal or detecting another transmitter. Thanks to the open collector outputs, it is possible to connect in parallel different reading stations enabling them one at a time with the ABU signal (output enable). The reading station is furnished with the female connector type D with 15 poles. Mostly used in: truck identification, pallets, automatic warehouse drawers, etc.

Technical data:

- Temperature range: -20° ÷ +70° C
- Sensing distance max: 12 mm at 25° C
- Working distance suggested: 7,5 mm
- Maximum speed during the transmission at 6 mm: 40 m/min
- Misalignment max (stopped position): 9 mm
- Misalignment max (at max speed): 6 mm
- Facing direction: possible in all directions
- Word format: binary 8 bit
- Protection against reversal polarity
- Protection against load inductive peak
- Protection against short circuit and overload
- Electromagnetic compatibility (EMC) according to EN61000-6-2/-4

Figure	Power supply	Power consumption	Weight	Transmission code	Connector terminations	INPUTS			OUTPUTS			ORDERING REFERENCES
						Input resistance	Logical 0 Input	Logical 1 Input	Output current max	Power supply max	Output polarity	
						KOhm	V	V	mA	Vdc		
SL - Reading station	20 ÷ 30	60	300	-	to solder	8,2	<12	>20	200	32	PNP open collector	ERB1109500R
E - Transmittor	-	-	32	selectable on dip-switch	-	-	off	on	-	-	-	ERB1000200E

- ERB 1
- Fixed code identification system
- Connections description

Fig. 1 - Input stage

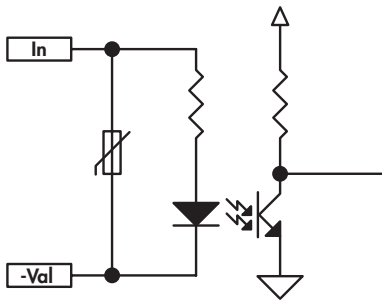

INPUTS:

The inputs have to be driven by devices with output type PNP and they are optically insulated in order to assure the highest noise immunity level. If they are left disconnected they assume the "0" logical condition (see fig. 1).

• **ABU (output enable): pin 11**

This input allows you to connect the Un outputs of different reading stations in parallel, enabling only the ones of the desired receiver. Keeping this signal high, the outputs get a high impedance; bringing it to a low level it is possible to have the reading of the output port. The AC and ACM influenced outputs are not influenced by this command.

• **RES (output and ACM resetting): pin 12**

One logical condition "1" on this input "cancels" the data on the output, resetting it. With this "1" logical level input it is not possible to have the transmitter reading; to enable the reading conditions you have to put to "0" this input. The AC output is not controlled by this command.

OUTPUTS:

All the outputs are open collector PNP type, so they have to be charged toward the negative. The maximum current available is 200 mA (see fig. 2).

• **U1 ÷ U8 (outputs) pin 1 ÷ 8**

On these outputs we have the binary code read by the transmitter. The output 8 represents the most significant bit (MSB) and the output 1 the least significant bit (LSB).

• **AC (Code acceptance): pin 10**

This output goes to a high level when it receives a correct code by the transmitter. The signal is shown by the yellow LED

• **ACM (Memorized code acceptance): pin 9**

This output goes to a high level when it receives a correct code by the transmitter. Differently by the AC signal this remains high even after the transmitter is removed. It can be cleared by a signal 1 on RES input.

Fig. 2 - Output stage

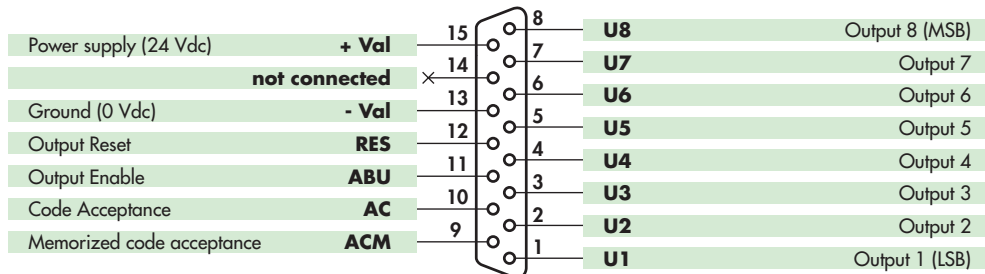
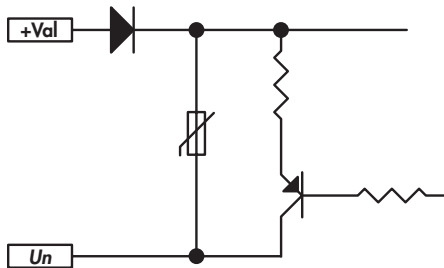

Mounting precautions

Both units can be mounted on metallic surfaces, not surrounded, without any changes of the working distance. The communication between the two units happens when the two active zones are one in front of the other. In this position the two units can rotate 360° without compromising the perfect function. The maximum misalignment that the two units can have is 9 mm in all directions (18 mm camp) working at a 6mm distance between transmitter and reader station. It is recommended not to couple connection cable to other power conductors. If so use separate raceway. In highly disturbed places it is suggested the use of shielded cables connected to earth.

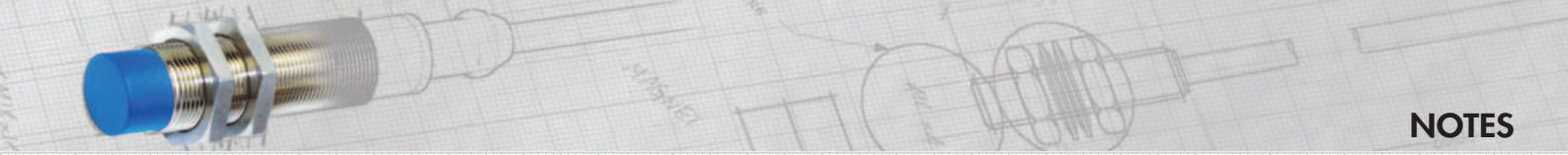

NOTES

NOTES

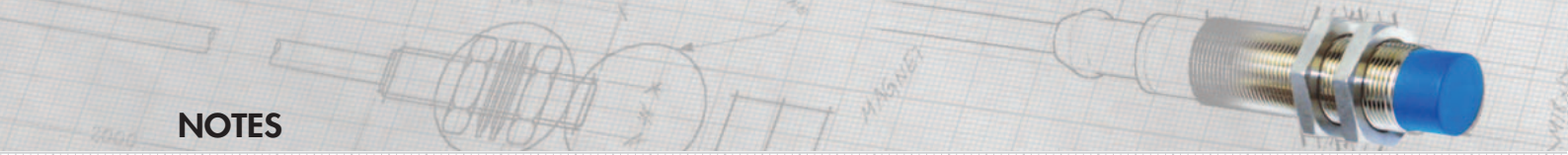

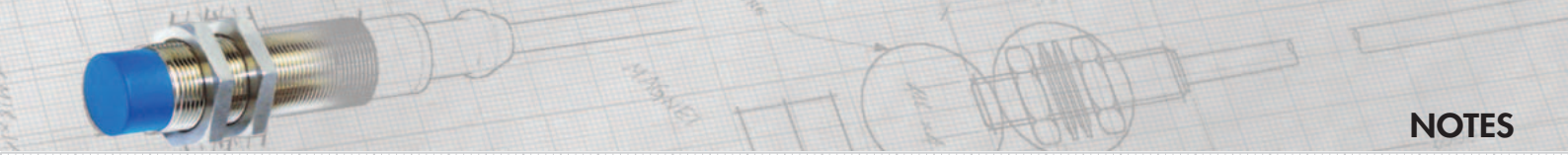

NOTES

NOTES

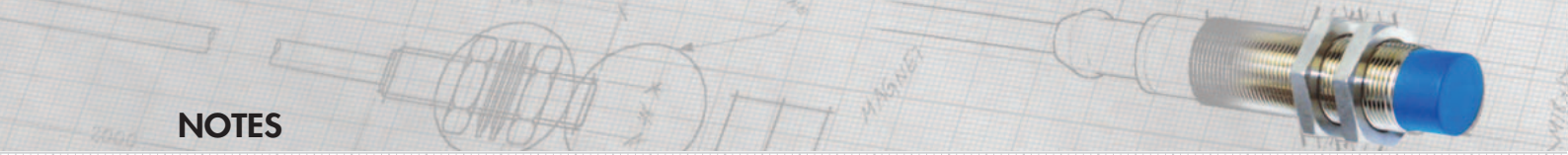

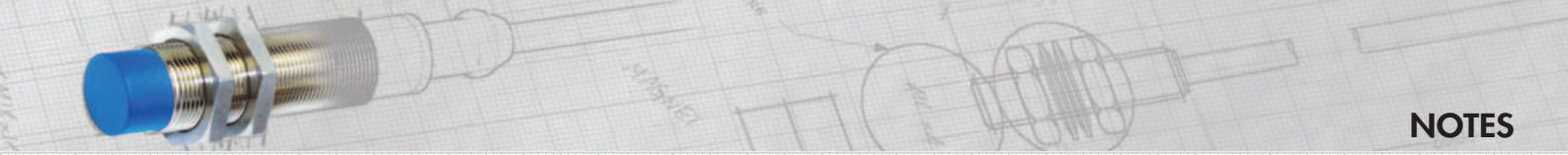

NOTES

The real appearance of the devices may be different from the parts showed on the pictures.
BDC Electronic srl retains that descriptions and subjects of catalogue can be changed without notice.
Copy and imitation of this catalogue are strictly forbidden.