



## MZT7, RZT7

MAXIMIZE WHAT MATTERS

Sensors for T-slot cylinders

**SICK**  
Sensor Intelligence.

# THE PERFECT CYLINDER SENSOR FOR STANDARD APPLICATIONS

The MZT7 magnetic cylinder sensor enables quick, precise and contactless sensing of the piston's position in compact pneumatic cylinders. It is easy to mount, can be used in numerous applications and offers an outstanding price-performance ratio.

## The Application Areas:

### Universal in Factory Automation

Assembly and handling machines, packaging machines and electronics production: The MZT7 magnetic cylinder sensor is the ideal solution for a multitude of applications and the widest range of cylinder types. It is so versatile that you only need one sensor variant. The advantages not only include savings on warehouse space and costs, but also the time spent on documentation and maintenance. The sensor is also available as RZT7 with reed technology and a supply voltage of up to 230 V - an especially cost-effective solution.

✔ Standardization reduces costs

## The Sensor Design:

### For Almost Every Cylinder Profile



The MZT7 magnetic cylinder sensor never loses its grip: when mounted directly in the T-slot, the universal housing design compensates for the various slot dimensions from the widest range of cylinder manufacturers. And for cylinders without a T-slot, such as round, tie-rod and profile cylinders, an extensive range of mounting adapter accessories are available.

✔ Can be mounted anywhere, directly or with an adapter



# AFFORDABLE RELIABILITY





### The combination screw: Truly Captive

The MZT7 magnetic cylinder sensor is mounted in the T-slot using a combination screw. It can be tightened using either an Allen key or a flat-blade screwdriver. Another advantage of the combination screw is that it is securely attached to the sensor housing and thus cannot be lost.

Fixed in place with a Allen key or flat-blade screwdriver

### The Mounting: easily inserted and locked

Thanks to its design, the MZT7 cylinder sensor can be easily inserted into the T-slot from above. The end caps of the pneumatic cylinder do not have to be removed. Side retaining ribs hold the sensor in position before the screw is tightened to secure it in the slot. A quarter turn of the combination screw completes the time-saving drop-in mounting and locks the sensor securely.

✔ Time-saving mounting and secure locking



### The Sensor: Secured in Every Situation

The combination screw fixes the sensor to the base of the cylinder slot. This prevents the MZT7 from slipping in the slot, even in the event of strong vibrations, tension on the sensor cable or slot dimension tolerances. Another advantage is that the sensor can be used within a wide temperature range.

Permanent switching reliability



MZT7

# MAXIMIZE WHAT MATTERS



### Product description

The SICK MZT7 magnetic cylinder sensor with GMR technology reliably detects the piston position in pneumatic drives. The MZT7 can be mounted directly into all cylinders with standard Tslots. SICK also has an extensive range of adapters which enable the MZT7 to

### At a glance

- Can be used in all standard cylinders, linear slides, and grippers using the T-slot and – with the help of adapters – in round rod, tie-rod, profile cylinders and dovetail groove cylinders

### Your benefits

- A sensor for a wide range of applications: The sensor design fits into all standard T-slots used around the world, regardless of the cylinder profile or manufacturer
- Simple mounting: Thanks to the retaining ribs on the side, the sensor holds its position even before the screw is tightened, ensuring that it does not fall out

be used with other cylinder types. The MZT7 is characterized by its simple mounting principle: Insert the sensor into the slot and rotate the locking screw a quarter turn to fix it securely to the cylinder.

- Easy to insert the sensor into the slot
- Locking screw combines an Allen key and slotted screw
- LED for indicating the output state
- IP 67 enclosure rating
- Fast mounting: The sensor is fixed quickly and securely in the slot simply by rotating the locking screw a quarter turn
- The rugged locking screw holds the sensor in the required position, even when exposed to shocks and vibrations
- It is easy to replace the sensor during servicing without removing the end caps

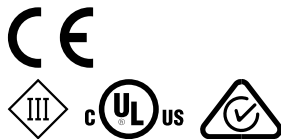

### Additional information

Detailed technical data .....5  
 Ordering information .....6  
 Dimensional drawing .....6  
 Connection type and diagram.....7  
 Recommended accessories ..... 12

- [www.mysick.com/en/MZT7](http://www.mysick.com/en/MZT7)



## Detailed technical data

## Features

cylinder type	T-slot
cylinder types with adapter	Profile cylinder Tie-rod cylinder Round body cylinder Dovetail groove cylinder SMC rail CDQ2 SMC rail ECDQ2
Housing length	29.5 mm
output type	PNP / NPN (depending on type)
Switching frequency, typ.	± 1,000 Hz
output function	NO / NC (depending on type)
enclosure rating <sup>1)</sup>	IP 65, IP 67

<sup>1)</sup> According to EN 60529.

## Mechanics/electronics

Supply voltage <sup>1)</sup>	10 V DC ... 30 V DC
Power consumption <sup>2)</sup>	≤ 8 mA
Voltage drop	≤ 2 V
continuous current $i_a$	≤ 100 mA
Protection class	III
response sensitivity, typ.	3 mT
overrun distance, typ.	10 mm
Hysteresis, typ.	< 0.8 mT
repeatability <sup>3)</sup>	≤ 0.1 mT
reverse polarity protection	I
Short-circuit protection	I
Ambient operating temperature	-30 °C ... +80 °C (PUR) -30 °C ... +70 °C (PVC) (depending on type)
Shock and vibration resistance	30 g, 11 ms / 10 ... 55 Hz, 1 mm
eMc	According to EN 60947-5-2
Housing material	Plastic
cable material	PUR / PVC (depending on type)
conductor cross-section	0.14 mm <sup>2</sup> / 0.12 mm <sup>2</sup> (depending on type)

<sup>1)</sup> Limit values when operated in short-circuit protected network: max. 8 A.<sup>2)</sup> Without load.<sup>3)</sup>  $U_b$  and  $T_a$  constant.

8018137/2016-03-04

# SENSORS FOR T-SLOT CYLINDERS

## MZT7

### Ordering information

#### MZT7

- Magnetic field sensitivity, min.: 3 mT

output type	output function	connection type	cable material	enclosure rating	connection diagram	Type	Part no.	
PNP	NO	Cable, 3-wire, 2 m	PUR	IP 65, IP 67	Cd-001	MZT7-03VPS-KU0	1070829	
			PVC	IP 65, IP 67	Cd-001	MZT7-03VPS-KW0	1070838	
		PUR	IP 65, IP 67	Cd-001	MZT7-03VPS-KUB	1070833		
		Cable, 3-wire, 5 m	PVC	IP 65, IP 67	Cd-001	MZT7-03VPS-KWB	1070842	
			Cable with connector M8, 3-pin, 0.3 m	PUR	IP 65, IP 67	Cd-002	MZT7-03VPS-KP0	1070814
			Cable with connector M8, 3-pin, with knurled nuts, 0.5 m	PUR	IP 65, IP 67	Cd-002	MZT7-03VPS-KR0	1070821
	Cable with connector M12, 3-pin, with knurled nuts, 0.3 m		PUR	IP 65, IP 67	Cd-002	MZT7-03VPS-KQ0	1070825	
	NC	Cable, 3-wire, 2 m	PUR	IP 65, IP 67	Cd-003	MZT7-03VPO-KU0	1070830	
		Cable with connector M8, 3-pin, 0.3 m	PUR	IP 65, IP 67	Cd-004	MZT7-03VPO-KP0	1070818	
		Cable, 3-wire, 2 m	PUR	IP 65, IP 67	Cd-001	MZT7-03VNS-KU0	1070831	
Cable, 3-wire, 5 m		PUR	IP 65, IP 67	Cd-001	MZT7-03VNS-KUB	1070835		
NPN	NO	Cable, 3-wire, 2 m	PVC	IP 65, IP 67	Cd-001	MZT7-03VNS-KW0	1070840	
		Cable, 3-wire, 5 m	PVC	IP 65, IP 67	Cd-001	MZT7-03VNS-KWB	1070844	
		PUR	IP 65, IP 67	Cd-002	MZT7-03VNS-KP0	1070819		
		Cable with connector M8, 3-pin, 0.3 m	PUR	IP 65, IP 67	Cd-002	MZT7-03VNS-KR0	1070823	
		Cable with connector M8, 3-pin, with knurled nuts, 0.5 m	PUR	IP 65, IP 67	Cd-002	MZT7-03VNS-KR0	1070823	
		Cable with connector M12, 3-pin, with knurled nuts, 0.3 m	PUR	IP 65, IP 67	Cd-002	MZT7-03VNS-KQ0	1070827	
	NC	Cable, 3-wire, 2 m	PUR	IP 65, IP 67	Cd-003	MZT7-03VNO-KU0	1070832	
		Cable with connector M8, 3-pin, 0.3 m	PUR	IP 65, IP 67	Cd-004	MZT7-03VNO-KP0	1070820	

### Dimensional drawing (Dimensions in mm (inch))

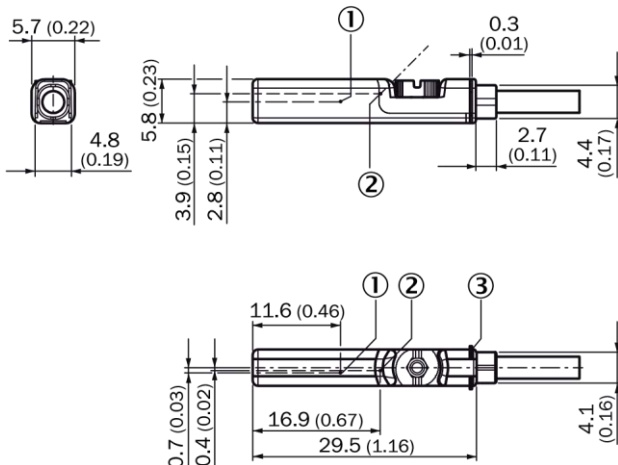



- 1 Position sensor element
- 2 Status LED
- 3 Retaining ribs

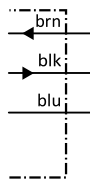
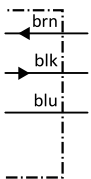
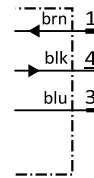
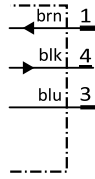

Connection type and diagram

Cd-001  
 + (L+) + (L+) + (L+) + (L+)  
 NONONCNC  
 - (M) - (M) - (M) - (M)

Cd-002

Cd-003

Cd-004

rZT7

# MAXIMIZE WHAT MATTERS



## Product description

The SICK RZT7 magnetic cylinder sensor with reed contact reliably detects the piston position in pneumatic drives. The RZT7 can be mounted directly into all cylinders with standard T-slots. SICK also has an extensive range of adapters

## At a glance

- Can be used in all standard cylinders, linear slides, and grippers using the T-slot and – with the help of adapters – in round rod, tie-rod, profile cylinders and dovetail groove cylinders
- Easy to insert the sensor into the slot

## Your benefits

- A sensor for a wide range of applications: The sensor design fits into all standard T-slots used around the world, regardless of the cylinder profile or manufacturer
- Simple mounting: Thanks to the retaining ribs on the side, the sensor holds its position even before the screw is tightened, ensuring that it does not fall out

which enable the RZT7 to be used with other cylinder types. The RZT7 is characterized by its simple mounting principle: Insert the sensor into the slot and rotate the locking screw a quarter turn to fix it securely to the cylinder.

- Locking screw combines an Allen key and slotted screw
- LED for indicating the output state
- IP 67 enclosure rating
- Supply voltage up to 230 V
- Fast mounting: The sensor is fixed quickly and securely in the slot simply by rotating the locking screw a quarter turn
- The rugged locking screw holds the sensor in the required position, even when exposed to shocks and vibrations
- It is easy to replace the sensor during servicing without removing the end caps

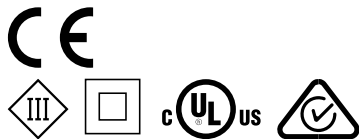

## Additional information

Detailed technical data .....9  
 Ordering information .....10  
 Dimensional drawings ..... 11  
 Connection type and diagram. .... 11  
 Recommended accessories ..... 12

- [www.mysick.com/en/rZT7](http://www.mysick.com/en/rZT7)



Detailed technical data

Features

	Ac/dc 2-wire	Ac/dc 3-wire
cylinder type	T-slot	
cylinder types with adapter	Profile cylinder Tie-rod cylinder Round body cylinder Dovetail groove cylinder SMC rail CDQ2 SMC rail ECDQ2	
Housing length	29.5 mm / 32.5 mm (depending on type)	29.5 mm
output type	Reed	
Switching frequency, typ.	± 400 Hz	
output function	NO / NC (depending on type)	NO
enclosure rating <sup>1)</sup>	IP 65, IP 67	

<sup>1)</sup> According to EN 60529.

Mechanics/electronics

	Ac/dc 2-wire	Ac/dc 3-wire
Supply voltage <sup>1)</sup>	5 V AC/DC ... 30 V AC/DC 5 V AC/DC ... 120 V AC/DC 5 V AC/DC ... 230 V AC/DC (depending on type)	5 V AC/DC ... 30 V AC/DC
Voltage drop	≤ 3.5 V	≤ 0.1 V <sup>2)</sup>
continuous current $i_a$	≤ 100 mA	≤ 500 mA (DC), ≤ 300 mA (AC)
Switching capacity	≤ 6 W	
Protection class	III / II (depending on type)	III
response sensitivity, typ.	3 mT	
overrun distance, typ.	10 mm	
repeatability <sup>3)</sup>	≤ 0.1 mT	
reverse polarity protection	–	I

<sup>1)</sup> Limit values when operated in short-circuit protected network: max. 8 A.

<sup>2)</sup> For cable length up to 0.3 m.

<sup>3)</sup>  $U_b$  and  $T_a$  constant.

## SENSORS FOR T-SLOT CYLINDERS

Ambient operating temperature	-30 °C ... +80 °C (PUR) -30 °C ... +70 °C (PVC) (depending on type)
Shock and vibration resistance	30 g, 11 ms / 10 ... 55 Hz, 1 mm
eMc	According to EN 60947-5-2
Housing material	Plastic
cable material	PUR / PVC (depending on type)
conductor cross-section	0.14 mm <sup>2</sup> / 0.12 mm <sup>2</sup> (depending on type)

rZT7

### Ordering information

#### AC/DC 2-wire

- **Electrical wiring:** AC/DC 2-wire •
- **Continuous current**  $I_a$ : ≤ 100 mA

Supply voltage	Protection class	output function	connection	cable material	enclosure connection rating <sup>1)</sup>	connection diagram	Type	Part no.
5 V AC/DC ... 30 V AC/DC	III	NO	Cable, 2-wire, 2 m	PUR	IP 65, IP 67	Cd-037	RZT7-03ZUS-KU0	1070861
				PVC	IP 65, IP 67	Cd-037	RZT7-03ZUS-KW0	1070865
			Cable, 2-wire, 5 m	PUR	IP 65, IP 67	Cd-037	RZT7-03ZUS-KUB	1070863
				PVC	IP 65, IP 67	Cd-037	RZT7-03ZUS-KWB	1070867
			Cable with connector M8, 3-pin, 0.3 m	PUR	IP 65, IP 67	Cd-038	RZT7-03ZUS-KP0	1070855
			Cable with connector M8, 3-pin, with knurled nuts, 0.5 m	PUR	IP 65, IP 67	Cd-038	RZT7-03ZUS-KR0	1070857
Cable with connector M12, 3-pin, with knurled nuts, 0.3 m	PUR	IP 65, IP 67	Cd-345	RZT7-03ZUS-KQ0	1070859			
5 V AC/DC ... 120 V AC/DC	II	NC	Cable, 2-wire, 2 m	PVC	IP 65, IP 67	Cd-037	RZT7-03ZVO-KW0	1070866
5 V AC/DC ... 230 V AC/DC	II	NO	Cable, 2-wire, 2 m	PUR	IP 65, IP 67	Cd-037	RZT7-03ZWS-KU0	1070869
				PVC	IP 65, IP 67	Cd-037	RZT7-03ZWS-KW0	1070871
			Cable, 2-wire, 5 m	PUR	IP 65, IP 67	Cd-037	RZT7-03ZWS-KUB	1070870
				PVC	IP 65, IP 67	Cd-037	RZT7-03ZWS-KWB	1070872

<sup>1)</sup> According to EN 60529.

#### AC/DC 3-wire

- **Electrical wiring:** AC/DC 3-wire •
- **Continuous current**  $I_a$ : ≤ 500 mA, ≤ 300 mA, DC, AC

Supply voltage	Protection class	output function	connection	cable material	enclosure rating <sup>1)</sup>	connection diagram	Type	Part no.
5 V AC/DC ... 30 V AC/DC	III	NO	Cable, 3-wire, 2 m	PUR	IP 65, IP 67	Cd-035	RZT7-03ZRS-KU0	1070850
				PVC	IP 65, IP 67	Cd-035	RZT7-03ZRS-KW0	1070852

<sup>1)</sup> According to EN 60529.

## SENSORS FOR T-SLOT CYLINDERS

			Cable, 3-wire, 5 m	PUR	IP 65, IP 67	Cd-035	RZT7-03ZRS-KUB	1070851
				PVC	IP 65, IP 67	Cd-035	RZT7-03ZRS-KWB	1070853
			Cable, 3-wire, 10 m	PVC	IP 65, IP 67	Cd-035	RZT7-03ZRS-KWD	1070854
				PUR	IP 65, IP 67	Cd-036	RZT7-03ZRS-KP0	1070847
			Cable with connector M8, 3-pin, with knurled nuts, 0.3 m	PUR	IP 65, IP 67	Cd-036	RZT7-03ZRS-KR0	1070848
			Cable with connector M12, 3-pin, with knurled nuts, 0.3 m	PUR	IP 65, IP 67	Cd-036	RZT7-03ZRS-KQ0	1070849

**rZT7**

### Dimensional drawings (Dimensions in mm (inch))

10 V AC/DC ... 30 V AC/DC

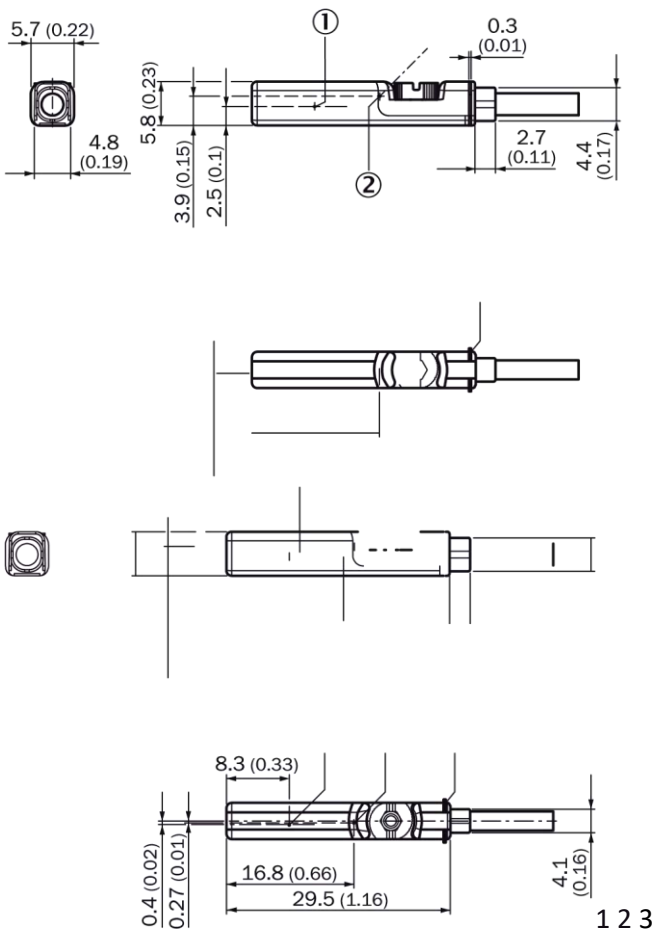

10 V AC/DC ... 120 V AC/DC

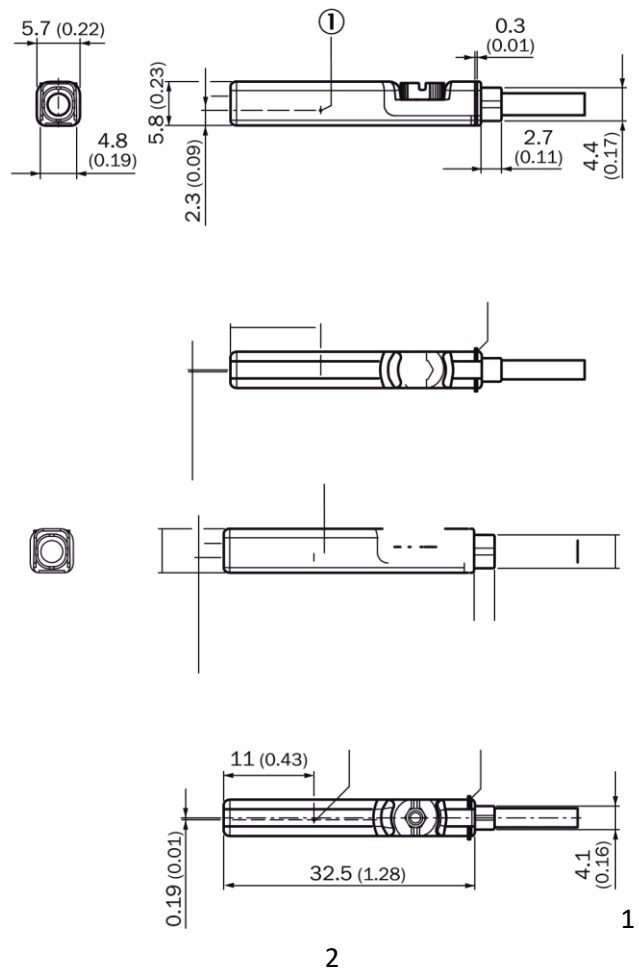

- |                           |                           |
|---------------------------|---------------------------|
| 1 Position sensor element | 1 Position sensor element |
| 2 Status LED              | 2 Retaining ribs          |
| 3 Retaining ribs          |                           |

10 V AC/DC ... 230 V AC/DC

## SENSORS FOR T-SLOT CYLINDERS

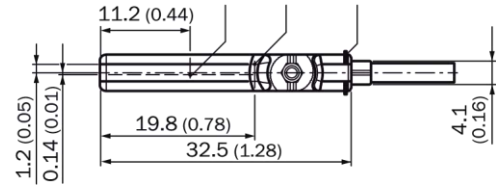
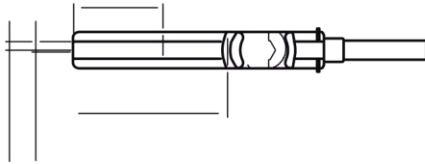
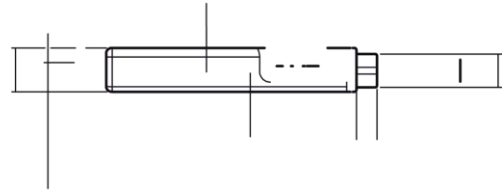
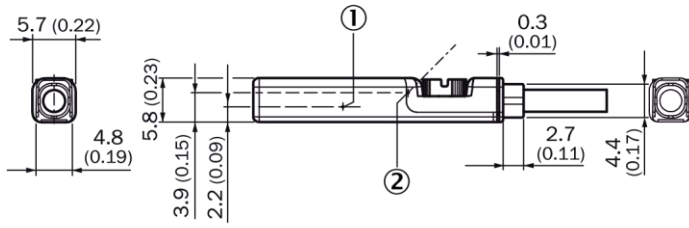

1 2 3

- 1 Position sensor element
- 2 Status LED
- 3 Retaining ribs

### Connection type and diagram

Cd-037

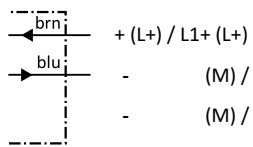

Cd-038

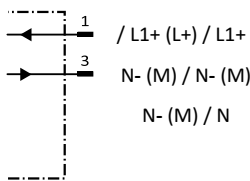

Cd-345

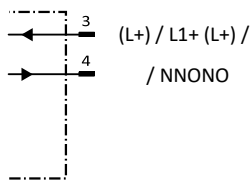

Cd-035

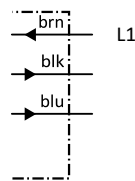

Cd-036

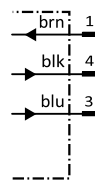

**Recommended accessories**

**Brackets for cylinder sensors**

Device protection (mechanical)



figure	Material	description	Type	Part no.
	Die-cast zinc	Protective adapter, compatible with MZT7, RZT7	BEF-SG-MRZT	2077201

figure	Material	description	Type	Part no.
--------	----------	-------------	------	----------

## Accessories SENSORS FOR T-SLOT CYLINDERS

	Aluminum	Mounting bracket for mounting on SMC rails ECDQ2 (T-slot)	BEF-KHZ-TT1	2046439
---	----------	---	-------------	---------

For cylinders with dovetail-slot

figure	Material	description	Type	Part no.
	Aluminum	Mounting bracket for cylinder with dovetail slot	BEF-KHZ-ST1	2022703

For profile cylinders and tie-rod cylinders

figure	Material	description	Type	Part no.
	Zinc diecast	Mounting bracket for integrated profile cylinder/tie-rod cylinder	BEF-KHZ-PT1	2022702

For round body cylinders

figure	Material	description	Type	Part no.
	Plastic, Aluminum	Mounting bracket on round body cylinder with piston diameter of 12 mm <sup>1)</sup>	BEF-KHZ-RT-12	2077681
		Mounting bracket on round body cylinder with piston diameter of 16 mm <sup>1)</sup>	BEF-KHZ-RT-16	2077680
		Mounting bracket on round body cylinder with piston diameter of 20 mm <sup>1)</sup>	BEF-KHZ-RT-20	2077679
	Plastic, Aluminum	Mounting bracket on round body cylinder with piston diameter of 25 mm <sup>1)</sup>	BEF-KHZ-RT-25	2077678
		Mounting bracket on round body cylinder with piston diameter of 32 mm <sup>1)</sup>	BEF-KHZ-RT-32	2077677
		Mounting bracket on round body cylinder with piston diameter of 40 mm <sup>1)</sup>	BEF-KHZ-RT-40	2077676
	Plastic, Aluminum	Mounting bracket on round body cylinder with piston diameter of 50 mm <sup>1)</sup>	BEF-KHZ-RT-50	2077675
		Mounting bracket on round body cylinder with piston diameter of 63 mm <sup>1)</sup>	BEF-KHZ-RT-63	2077674
	Stainless steel, die cast	Mounting bracket on round body cylinder with piston diameter of 8 mm ... 25 mm	BEF-KHZ-RT1-25	2077682
		Mounting bracket on round body cylinder with piston diameter of 8 mm ... 63 mm	BEF-KHZ-RT1-63	2077683
		Mounting bracket on round body cylinder with piston diameter of 8 mm ... 130 mm	BEF-KHZ-RT1-130	2077684
figure	Material	description	Type	Part no.
	Aluminum	Mounting bracket for mounting on SMC rails CDQ2 (T-slot)	BEF-KHZ-TT2	2046440

### Plug connectors and cables

Connecting cables with female connector



<sup>1)</sup> Ambient temperature min 0 °C max 50 °C.

For SMC rails CDQ2 (T-slot)



For SMC rails ECDQ2 (T-slot)





M12, 3-pin, PUR, halogen-free

figure	connection type head A	connection type head B	connecting cable	Type	Part no.
	Female connector, M12, 3-pin, straight, unshielded	Cable, open conductor heads	5 m, 3-wire	DOL-1203-G05MC	6039076
			10 m, 3-wire	DOL-1203-G10MC	6039077
	Female connector, M12, 3-pin, angled, unshielded	Cable, open conductor heads	5 m, 3-wire	DOL-1203-W05MC	6039079
			10 m, 3-wire	DOL-1203-W10MC	6036752

M8, 3-pin, PVC, chemical resistant

figure	connection type head A	connection type head B	connecting cable	Type	Part no.
	Female connector, M8, 3-pin, straight, unshielded	Cable, open conductor heads	2 m, 3-wire	DOL-0803-G02M	6010785
			5 m, 3-wire	DOL-0803-G05M	6022009
	Female connector, M8, 3-pin, angled, unshielded	Cable, open conductor heads	2 m, 3-wire	DOL-0803-W02M	6008489
			5 m, 3-wire	DOL-0803-W05M	6022010

Female connectors (ready to assemble)

figure	connection type head A	connection type head B	Type	Part no.
	Female connector, M8, 3-pin, straight, unshielded	Screw-type terminals	DOS-0803-G	7902077
	Female connector, M8, 3-pin, angled, unshielded	Solder connection	DOS-0803-W	7902078

Male connectors (ready to assemble)

figure	connection type head A	connection type head B	Type	Part no.
	Male connector, M8, 3-pin, straight, unshielded	Screw-type terminals	STE-0803-G	6037322

**Dimensional drawings for accessories** (Dimensions in mm (inch))

Device protection (mechanical)

BEF-SG-MRZT

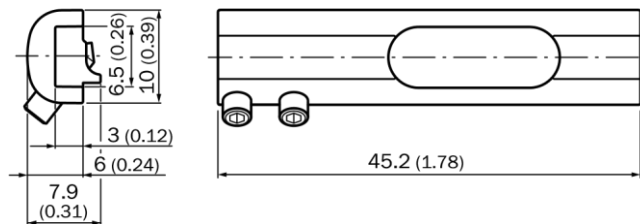

For cylinders with dovetail-slot

BEF-KHZ-ST1

# Accessories SENSORS FOR T-SLOT CYLINDERS

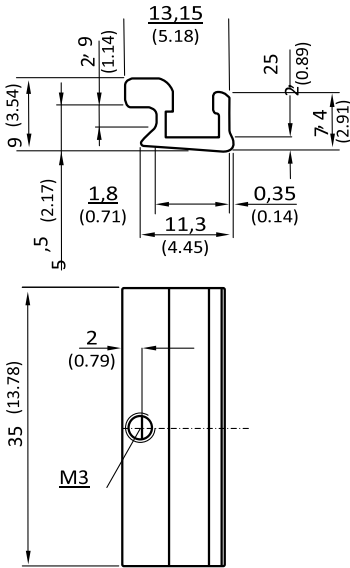

For profile cylinders and tie-rod cylinders  
BEF-KHZ-PT1

Ø min. 5 (.2);  
max. 19 (.75)

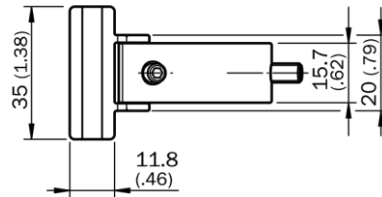
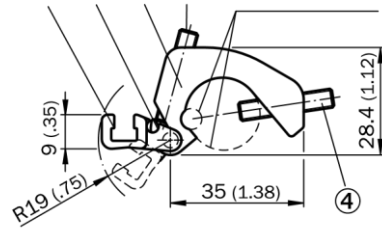
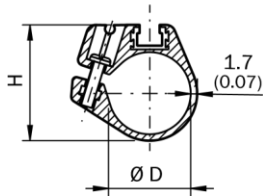

- 1 Sensoradapter with T-Slot
- 2 Fixing for cable <math>\varnothing</math> 3.2 mm ( 0.126 inch)
- 3 Cylinderadapter
- 4 Mounting screws M5

For round body cylinders  
BEF-KHZ-RT-xx

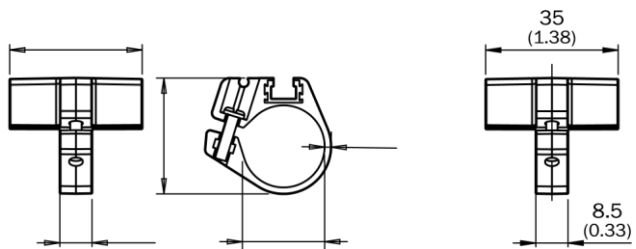

Part no.	Type	Ø d	cylinder H	piston Ø
2077681	BEF-KHZ-RT-12	13.5	12	22.4
2077680	BEF-KHZ-RT-16	17.7	16	26.6

2077679	BEF-KHZ-RT-20	21.7	20	30.6
2077678	BEF-KHZ-RT-25	26.8	25	35.7
2077677	BEF-KHZ-RT-32	34	32	42.9
2077676	BEF-KHZ-RT-40	42	42	50.9
2077675	BEF-KHZ-RT-50	52.9	50	61.8

2077674 BEF-KHZ-RT-63  
BEF-KHZ-RT1-xx

65 63 73.9

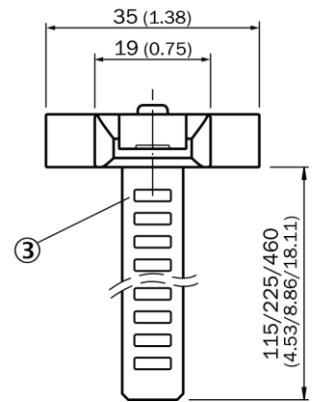
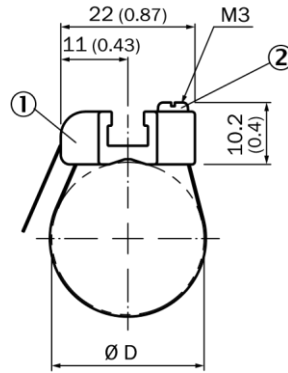

- 1 Sensoradapter with T-slot
- 2 Fixing screw
- 3 Strap

Part no.	Type	Ø d (cylinder piston)
2077682	BEF-KHZ-RT1-25	8 ... 25
2077683	BEF-KHZ-RT1-63	8 ... 63

For SMC rails CDQ2 (T-slot)  
BEF-KHZ-TT2

## Accessories SENSORS FOR T-SLOT CYLINDERS

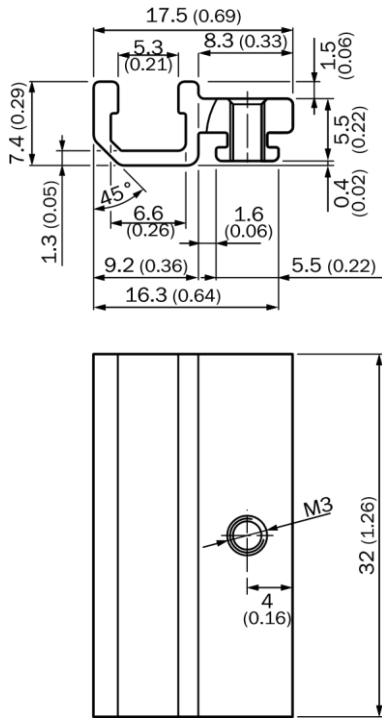

2077684 BEF-KHZ-RT1-130 8 ...  
130

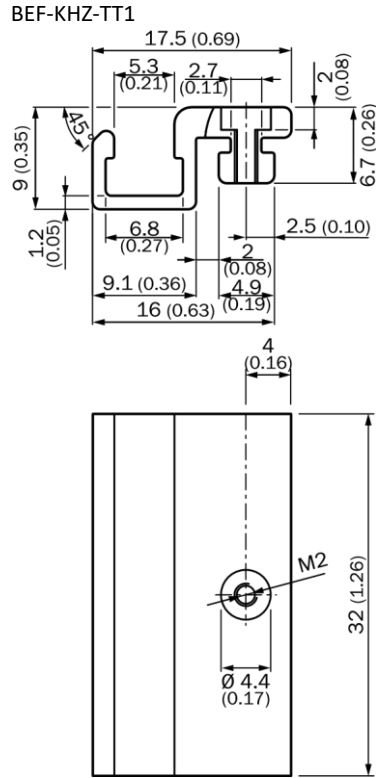

For SMC rails ECDQ2 (T-slot)

Connecting cables with female connector

DOL-1203-GxxMC

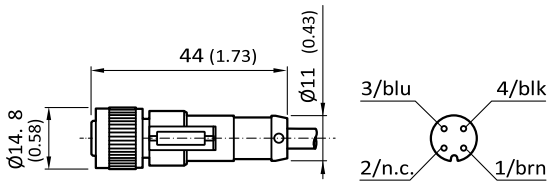

DOL-1203-WxxMC

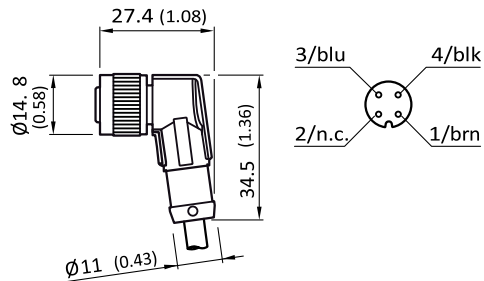

DOL-0803-GxxM

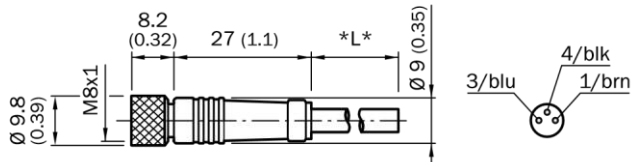

DOL-0803-WxxM

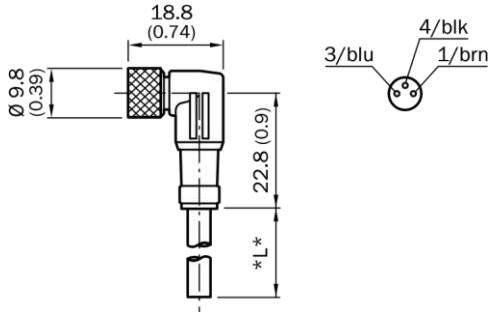

Female connectors (ready to assemble)

DOS-0803-G

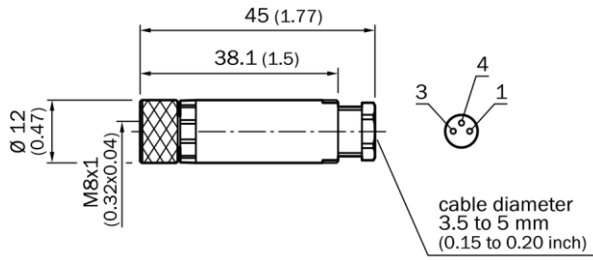

DOS-0803-W

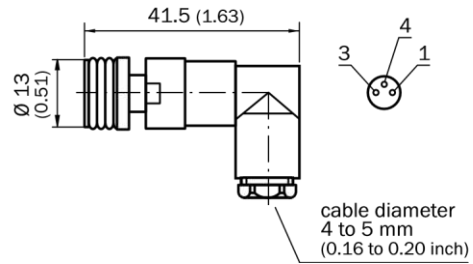





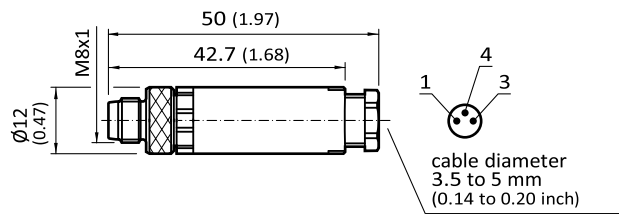



Male connectors (ready to assemble)

STE-0803-G





## REGISTER AT WWW.SICK.COM TODAY AND ENJOY ALL THE BENEFITS

-  Select products, accessories, documentation and software quickly and easily.
-  Create, save and share personalized wish lists.
-  View the net price and date of delivery for every product.
-  Requests for quotation, ordering and delivery tracking made easy.
-  Overview of all quotations and orders.
-  Direct ordering: submit even very complex orders in moments.
-  View the status of quotations and orders at any time. Receive e-mail notifications of status changes.
-  Easily repeat previous orders.
-  Conveniently export quotations and orders to work with your systems.



## SERVICES FOR MACHINES AND SYSTEMS: SICK LifeTime Services

Our comprehensive and versatile LifeTime Services are the perfect addition to the comprehensive range of products from SICK. The services range from product-independent consulting to traditional product services.



### Consulting and design

Safe and professional



### Product and system support

Reliable, fast and on-site



### Verification and optimization

Safe and regularly inspected



### Upgrade and retrofits

Easy, safe and economical



### Training and education

Practical, focused and professional



## SICK AT A GLANCE

SICK is a leading manufacturer of intelligent sensors and sensor solutions for industrial applications. With almost 7,000 employees and over 50 subsidiaries and equity investments as well as numerous representative offices worldwide, we are always close to our customers. A unique range of products and services creates the perfect basis for controlling processes securely and efficiently, protecting individuals from accidents and preventing damage to the environment.

We have extensive experience in various industries and understand their processes and requirements. With intelligent sensors, we can deliver exactly what our customers need. In application centers in Europe, Asia and North America, system solutions are tested and optimized in accordance with customer specifications. All this makes us a reliable supplier and development partner.

Comprehensive services round out our offering: SICK LifeTime Services provide support throughout the machine life cycle and ensure safety and productivity.

for us, that is “Sensor intelligence.”

Worldwide presence:

Australia, Austria, Belgium, Brazil, Canada, Chile, China, Czech Republic, Denmark, Finland, France, Germany, Great Britain, Hungary, India, Israel, Italy, Japan, Malaysia, Mexico, Netherlands, New Zealand, Norway, Poland, Romania, Russia, Singapore, Slovakia, Slovenia, South Africa, South Korea, Spain, Sweden, Switzerland, Taiwan, Thailand, Turkey, United Arab Emirates, USA, Vietnam.

Detailed addresses and additional representatives – [www.sick.com](http://www.sick.com)