

S10 SERIES

The **S10** series, in a practical and sturdy tubular M18 metal housing, suits the more difficult applications in the mechanical or food industries.

The IP69K mechanical protection guarantees resistance to washdown with water jets at high temperatures reaching 80°C and pressure reaching 100 bar.

Moreover, AISI-316L stainless steel versions are available for a major resistance towards chemical agents and aggressive detergents as well as to acid corrosion.

The lens in PMMA plastic offers the possibility of mounting a glass MEK-proof protection. A reflector with IP69K mechanical protection is available for the retroreflex versions.

The **S10** series includes adjustable proximity versions reaching 10, 35 or 60 cm and 14 mm fixed focus proximity, 4 m retroreflex and 3 m polarised retroreflex, 0.8 m retroreflex for transparents as well as 18 m through beam models.

The M12 connection requires only 3 wires for power supply and NPN or PNP output.



HIGHLIGHTS

- High excess-gain and operating distances
- IP69K mechanical protection
- AISI-316L stainless steel versions
- Standard 3 wire configuration output

APPLICATIONS

Ceramics

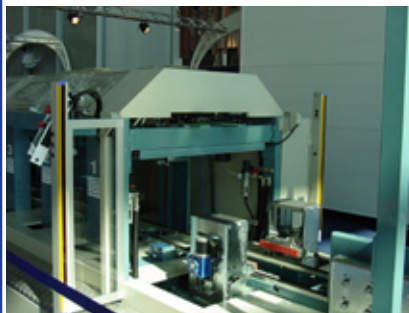

Transportation lines





Beverage & Bottling



Packaging lines for Food & Pharma



TECHNICAL DATA

Power supply:	10 ... 30 Vdc, reverse polarity protection
Consumption:	30 mA max.
Light emission:	infrared LED 880 nm red LED 660 nm (B, D, T vers.)
Diffuse proximity operating distance:	1 ... 10 cm (C01), 1 ... 35 cm (C11), 1 ... 60 cm (C21)
Fixed focus operating distance:	14 mm with 1.5 mm spot
Retroreflex operating distance:	0.1 ... 4 m (on R2)
Polarised retroreflex operating distance:	0.1 ... 3 m (on R2)
RRX for transparents operating distance:	0.1 ... 0.8 m (on R2)
Through beam operating distance:	0 ... 18 m
Setting:	sensitivity trimmer
Indicators:	yellow OUTPUT LED green STABILITY LED green POWER LED (G vers.)
Output type:	NPN or PNP, open collector
Saturation voltage:	1 V max.
Output current:	150 mA max., short-circuit protection
Response time:	1 ms max. 2 ms max. (F vers.)
Switching frequency:	500 Hz max. 250 Hz max. (F vers.)
Emitter Test input:	Test + (XE vers.) Test - (XF vers.)
Connection:	M12 4-pole connector
Electrical protection:	class 1
Mechanical protection:	IP69K
Housing material:	nickel-plated brass (S10-MA vers.) AISI 316L stainless steel (S10-NA vers.)
Lens material:	PMMA plastic
Weight:	50 g max.
Operating temperature:	-25 ... +55°C
Storage temperature:	-25 ... +70°C
Reference standard:	EN 60947-5-2
Certifications:	   I13DG

The operating distances indicate the detection distance with excess gain 2.

DETECTION DIAGRAMS

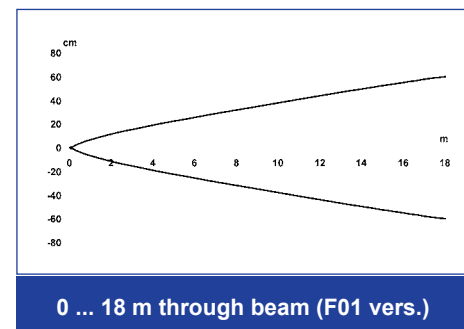
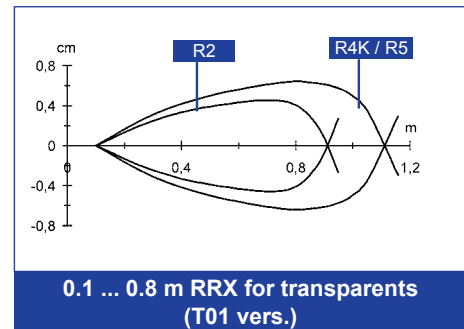
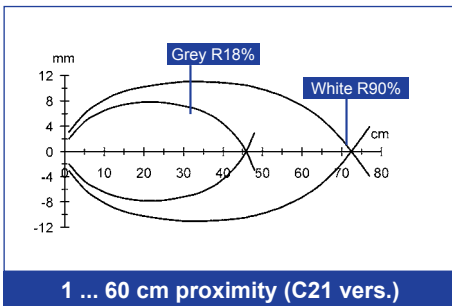
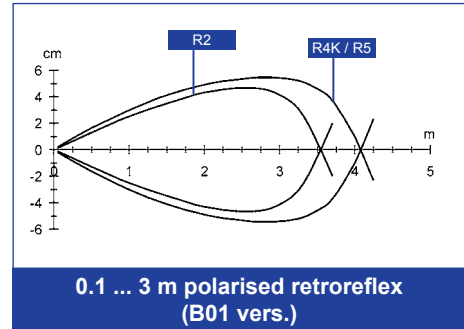
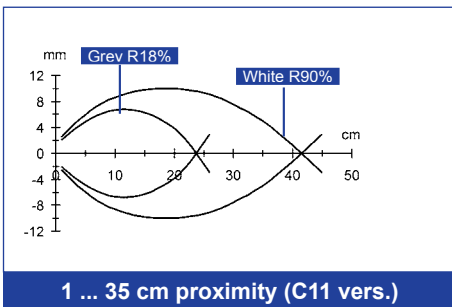
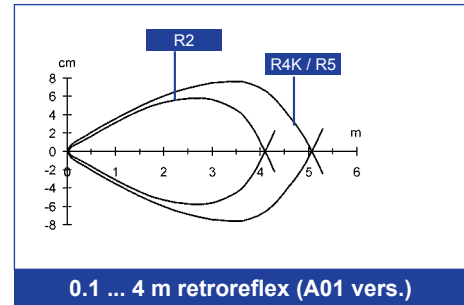
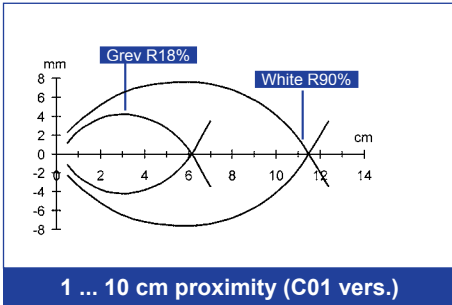

The detection diagrams indicate the typical operating distance with excess gain 1..

CONNECTIONS

NPN OUTPUT

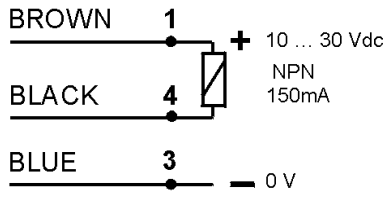

PNP OUTPUT

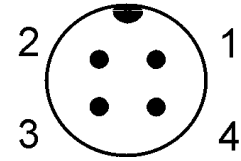
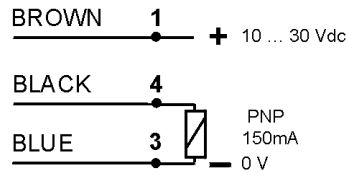

M12 CONNECTOR

S10-XX-5-A / B / C / D / F / T

TEST +

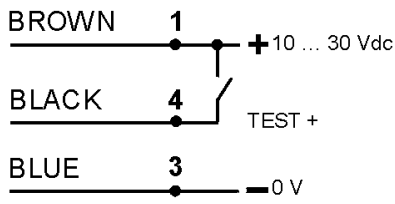

S10-XX-5-G00-XE

TEST -

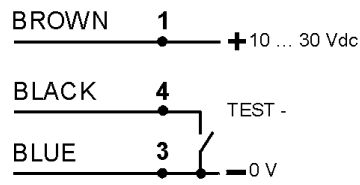

S10-XX-5-G00-XF

DIMENSIONS

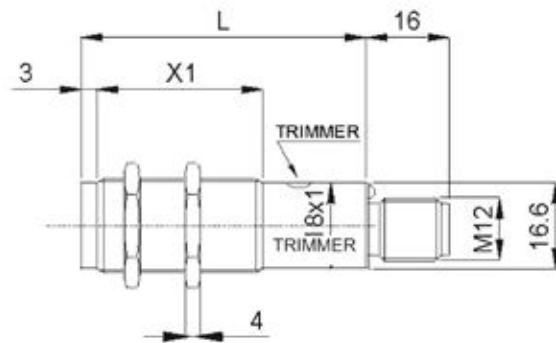
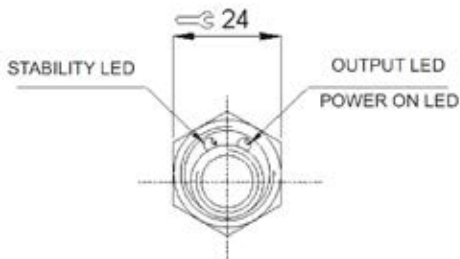

MODELS			
	A01/C01/C11C21/D14/F01/T01	B01	G00
L	65.1	67.4	55.1
X1	41.3	43.6	31.3

R4K REFLECTOR

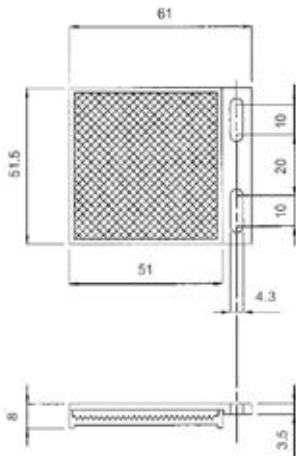

MEK PROOF

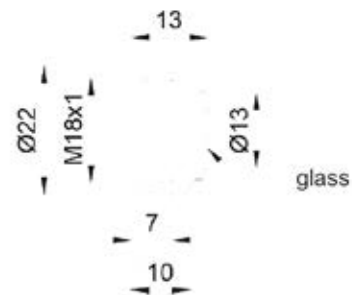

mm

MODEL SELECTION AND ORDER INFORMATION

Model	Optic Function	Housing	Out (In)	Order N°
S10-MA-5-A01-ND	retroreflex	nickel plated brass	NPN, dark	952101100
S10-MA-5-A01-NL	retroreflex	nickel plated brass	NPN, light	952101110
S10-MA-5-A01-PD	retroreflex	nickel plated brass	PNP, dark	952101120
S10-MA-5-A01-PL	retroreflex	nickel plated brass	PNP, light	952101130
S10-NA-5-A01-ND	retroreflex	AISI 316L stainless steel	NPN, dark	952101420
S10-NA-5-A01-PD	retroreflex	AISI 316L stainless steel	PNP, dark	952101440
S10-MA-5-B01-ND	polarised retroreflex	nickel plated brass	NPN, dark	952101140
S10-MA-5-B01-NL	polarised retroreflex	nickel plated brass	NPN, light	952101150
S10-MA-5-B01-PD	polarised retroreflex	nickel plated brass	PNP, dark	952101160
S10-MA-5-B01-PL	polarised retroreflex	nickel plated brass	PNP, light	952101170
S10-NA-5-B01-ND	polarised retroreflex	AISI 316L stainless steel	NPN, dark	952101460
S10-NA-5-B01-PD	polarised retroreflex	AISI 316L stainless steel	PNP, dark	952101480
S10-MA-5-T01-ND	retroreflex for transparents	nickel plated brass	NPN, dark	952101180
S10-MA-5-T01-NL	retroreflex for transparents	nickel plated brass	NPN, light	952101190
S10-MA-5-T01-PD	retroreflex for transparents	nickel plated brass	PNP, dark	952101200
S10-MA-5-T01-PL	retroreflex for transparents	nickel plated brass	PNP, light	952101210
S10-NA-5-T01-ND	retroreflex for transparents	AISI 316L stainless steel	NPN, dark	952101500
S10-NA-5-T01-PD	retroreflex for transparents	AISI 316L stainless steel	PNP, dark	952101520
S10-MA-5-C01-PD	short distance proximity	nickel plated brass	PNP, dark	952101240
S10-MA-5-C01-PL	short distance proximity	nickel plated brass	PNP, light	952101250
S10-MA-5-C01-ND	short distance proximity	nickel plated brass	NPN, dark	952101220
S10-MA-5-C01-NL	short distance proximity	nickel plated brass	NPN, light	952101230
S10-NA-5-C01-NL	short distance proximity	AISI 316L stainless steel	NPN, light	952101550
S10-NA-5-C01-PL	short distance proximity	AISI 316L stainless steel	PNP, light	952101570
S10-MA-5-C11-ND	medium distance proximity	nickel plated brass	NPN, dark	952101260
S10-MA-5-C11-NL	medium distance proximity	nickel plated brass	NPN, light	952101270

MODEL SELECTION AND ORDER INFORMATION

Model	Optic Function	Housing	Out (In)	Order N°
S10-MA-5-C11-PD	medium distance proximity	nickel plated brass	PNP, dark	952101280
S10-MA-5-C11-PL	medium distance proximity	nickel plated brass	PNP, light	952101290
S10-NA-5-C11-NL	medium distance proximity	AISI 316L stainless steel	NPN, light	952101590
S10-NA-5-C11-PL	medium distance proximity	AISI 316L stainless steel	PNP, light	952101610
S10-MA-5-C21-NL	long distance proximity	nickel plated brass	NPN, light	952101310
S10-MA-5-C21-PL	long distance proximity	nickel plated brass	PNP, light	952101330
S10-NA-5-C21-NL	long distance proximity	AISI 316L stainless steel	NPN, light	952101630
S10-NA-5-C21-PL	long distance proximity	AISI 316L stainless steel	PNP, light	952101650
S10-MA-5-D01-NL	fixed focus proximity	nickel plated brass	NPN, dark	952101340
S10-MA-5-D01-PL	fixed focus proximity	nickel plated brass	PNP, light	952101350
S10-NA-5-D01-NL	fixed focus proximity	AISI 316L stainless steel	NPN, light	952101660
S10-NA-5-D01-PL	fixed focus proximity	AISI 316L stainless steel	PNP, light	952101670
S10-MA-5-F01-ND	receiver	nickel plated brass	NPN, dark	952101360
S10-MA-5-F01-NL	receiver	nickel plated brass	NPN, light	952101370
S10-MA-5-F01-PD	receiver	nickel plated brass	PNP, dark	952101380
S10-MA-5-F01-PL	receiver	nickel plated brass	PNP, light	952101390
S10-NA-5-F01-ND	receiver	AISI 316L stainless steel	NPN, dark	952101680
S10-NA-5-F01-PD	receiver	AISI 316L stainless steel	PNP, dark	952101700
S10-MA-5-G00-XF	emitter	nickel plated brass	(Test -)	952101400
S10-MA-5-G00-XE	emitter	nickel plated brass	(Test +)	952101410
S10-NA-5-G00-XF	emitter	AISI 316L stainless steel	(Test -)	952101720
S10-NA-5-G00-XE	emitter	AISI 316L stainless steel	(Test +)	952101730

ACCESSORY SELECTION AND ORDER INFORMATION

Model	Description	Code N°
R4K	IP69K plastic reflector 51 x 61 mm	95A151220
MEK-proof	front protection	G5000001
SP-40	fixed support for tubular M18 sensors	95ACC1370

Please refer also to **Sensor Accessories**.